



VORTEX®



2020 CATALOG



CONTACT US

VORTEX® IS HERE TO HELP

CALL (800) 426-0048

EMAIL INFO@VORTEXOPTICS.COM

Or visit us at

ONE VORTEX DRIVE, BARNEVELD, WI 53507

CONTENTS

18 RIFLESCOPES

- 21 Razor® HD AMG®
- 23 Razor® HD Gen III
- 25 Razor® HD Gen II
- 27 Razor® HD Gen II-E
- 29 Razor® HD
- 31 Golden Eagle® HD
- 33 Viper® PST™ Gen II
- 35 Viper® HST™
- 37 Viper® HSLR™/ HS™
- 39 Viper®
- 41 Strike Eagle®
- 43 Diamondback® Tactical
- 45 Diamondback®
- 47 Crossfire® II 30mm
- 49 Crossfire® II 1in
- 50 Rifle Scope Accessories

56 RED DOTS

- 59 Razor® AMG® UH-1®
- 61 SPARC® AR
- 63 Strikefire® II
- 65 Crossfire®
- 66 Razor®
- 67 Viper®
- 67 Venom®
- 68 Spitfire™ 3X
- 69 Spitfire™ AR
- 71 Red Dot Accessories

72 RANGEFINDERS

- 75 Razor™ HD 4000
- 77 Ranger®
- 79 Impact®

82 BINOCULARS

- 85 Razor® UHD
- 87 Razor® HD
- 89 Viper® HD
- 91 Diamondback® HD
- 93 Crossfire® HD
- 94 Kaibab® HD
- 95 Vulture® HD
- 97 Fury® HD 5000
- 98 Raptor™
- 99 Vanquish®
- 100 Binocular Accessories

106 MONOCULARS

- 108 RECCE Pro® HD
- 109 Recon® R/T
- 110 Solo®
- 111 Solo® R/T

116 SPOTTING SCOPES

- 119 Razor® HD
- 121 Viper® HD
- 123 Diamondback®
- 124 Tripods
- 125 Spotting Scope Accessories

INFORMATION

- 6 Features Descriptions
- 126 Rifle Scope Specs
- 128 Rifle Scope Dimensions
- 129 Red Dot Specs
- 129 Rangefinder Specs
- 130 Binocular Specs
- 131 Monocular Specs
- 131 Spotting Scope Specs
- 131 Tripod Specs
- 132 Reticles

TRAILBLAZERS

- 52 Jerry Miculek
- 80 Remi Warren
- 104 Jeremiah Doughty
- 112 Doug Duren

EXTRA STUFF

- 8 Introducing the Razor® HD Gen III
- 10 Vortex Wear
- 14 Take Your Best Shot
- 114 Public Lands
- 136 Vortex Nation® Podcast
- 138 Vortex Nation®



WHAT'S YOUR STORY?

Who said life should be comfortable?

Since when was the easy path the one worth taking?

Shouldn't you always try for one more rep, one more shot in the ten ring, one more hour of daylight out there, where the wind shakes the trees and you never know what's waiting over the next ridge?

When it counts, where does your story begin?

Our story has always started with you. Every time your heart skips a beat when you're glassing a mountain and that bull appears; every time you feel the adrenaline sizzle in your blood at a "Shooter ready?" call; every time you bring us along for range day; and every time you trust us with your life in the line of duty you're telling the story of what it means to belong to Vortex Nation®.

We're honored to be a part of your life, and we're inspired by playing at least a small part in your story. Together, let's make 2020 the kind of year you tell your grandkids about.

FEATURES



UHD OPTICAL SYSTEM

Ultra high definition optical quality and prescription for unparalleled image resolution that cuts chromatic aberration; providing exceptional color fidelity, edge-to-edge sharpness, and light transmission.



HD OPTICAL SYSTEM

Optimized with select glass elements to deliver exceptional resolution, cut chromatic aberration and provide outstanding color fidelity, edge-to-edge sharpness, and light transmission.



XD™ OPTICAL SYSTEM

Premium optical system delivers impressive resolution, edge-to-edge sharpness, greatly reduces chromatic aberration and guarantees bright, high-contrast images.



SD OPTICAL SYSTEM

High-quality optical system reduces chromatic aberration and delivers clean, bright, sharp images.



XR™ PLUS LENS COATINGS

Ultimate anti-reflective coatings on all air-to-glass surfaces provide maximum light transmission for peak clarity and the pinnacle of low-light performance.



XR™ LENS COATINGS

Premium anti-reflective coatings on all air-to-glass surfaces provide superior light transmission for exceptional clarity and low-light performance.



FULLY MULTI-COATED LENSES

Anti-reflective coatings on all air-to-glass surfaces provide increased light transmission for greater clarity and low light performance.



DIELECTRIC PRISM COATINGS

Multi-layer prism coatings provide bright, clear, color-accurate images.



ALO ALIGNMENT

Proprietary, precision-laser process, perfectly aligns lens elements to ensure the absolute best image.



PHASE CORRECTION

Coating on roof prism enhances resolution and contrast.



APO (APOCHROMATIC)

Index-matched lenses correct color across the entire visual spectrum.



ARMORTEK®

Ultra-hard exterior lens coatings defend against scratches, oil and dirt.



RUBBER ARMOR

Provides a secure, non-slip grip and durable external protection.



PLASMA TECH

Cutting edge application process provides unparalleled coating durability and performance.



ARGON GAS PURGED

Gas purged and O-ring sealed for superior fogproof and waterproof performance in the most extreme conditions.



NITROGEN GAS PURGED

Gas purged and O-ring sealed for fogproof and waterproof performance in all conditions.



SHOCKPROOF

Designed to withstand the highest levels of recoil and impact.



WATERPROOF

Designed to withstand harsh weather conditions.



FOGPROOF

Designed to withstand a wide range of temperatures.



TRIPOD APAPTABLE

Allowing use on a tripod or car window mount. Tripod adapter required.



OUR VIP WARRANTY IS ABOUT YOU, NOT US

VIP stands for a Very Important Promise to you, our customer. We will repair or replace your Vortex® product in the event it becomes damaged or defective—at no charge to you. If we cannot repair your product, we will replace it with a product in perfect working order of equal or better physical condition.

It doesn't matter how it happened, whose fault it was, or where you purchased it: The VIP Warranty is fully transferrable, no receipt needed. If you ever have a problem, no matter the cause, we promise to take care of you. You can count on the VIP Warranty for all Vortex® Optics riflescopes, prism scopes, red dots, rangefinders, binoculars, spotting scopes, tripods, monoculars, gear, and apparel.

**UNLIMITED.
UNCONDITIONAL.
LIFETIME WARRANTY.**

VortexOptics.com • (800) 426-0048
One Vortex Drive, Barneveld, Wisconsin 53507

The VIP Warranty does not cover loss, theft, deliberate damage, or cosmetic damage that does not hinder the performance of the product.

EVERYTHING IS IN RANGE.

RAZOR® HD GEN III 1-10x24 FFP

NEW
2020



RAISE YOUR EXPECTATIONS 10X HIGHER.

The Razor® HD Gen III 1-10x is nothing less than your opportunity to shoot without limits. How? We took the optical clarity and versatility of the Razor® HD Gen II and cranked it up to 10 without adding any length or weight to the platform, delivering a first focal plane, daylight-bright reticle with 10x power that lets you own the downrange game in any lighting situation.





NEW
ITEMS
AVAILABLE IN
MARCH

FIT FOR EVERYWHERE

EVERYDAY COMFORT FOR THOSE WHO SEEK ADVENTURE.

- A. VORTEX RANGE DAY LOGO CAP
219085-BLK | One size fits most.
- B. VORTEX SUNSLAYER™ HOODIE
119013 | XS-3XL
- F. VORTEX HAMMERSTONE
SHORT SLEEVE SHIRT
120-06 | M-3XL

Up in the mountains and out in the woods. At the range and on the firing line. You wouldn't be here if you didn't like putting yourself out there.

As much as you love those places, you know what they can do to your mind, your body, and your clothes. In fact, when you get right down to it, it's the bumps and bruises, the challenges of failure and sweet moments of success that keep you coming back for more.

VORTEX WEAR IS MADE FOR YOU.

Designed for everyday wear but built for adventure, these are clothes that work as hard as you do. And, because you can't spend every moment in the field, our gear looks just as good in the office and out on the town as it does running 3-Gun or scouting that bull elk.

Every stitch is a promise, our guarantee that we've handpicked fabrics and developed one-of-a-kind styles to help you pursue your passion in comfort and style, wherever life takes you.



- VORTEX SUNSLAYER™ HOODIE -

LOADED WITH TECH
ON THE INSIDE SO YOU
CAN BE COMFORTABLE
OUTSIDE



B. VORTEX SUNSLAYER™ HOODIE

The Vortex Men's Sunslayer™ Hoodie is the ultimate remedy for sun protection as a standalone or base layer when you need to layer up. UPF 50 sun protection and anti-microbial technology keep you comfortable and fresh while 4-way stretch fabric allows for freedom of movement – no matter what challenge lies in your path.

119013 | XS-3XL

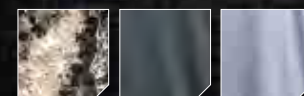

REALTREE™ EXCAPE OLIVE HEATHER COOL GREY

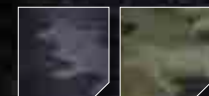

DEPTH CAMO HEATHER PINE CAMO

C. VORTEX PATCH LOGO CAP

120-40 | One size fits most.

- VORTEX DAY RUCKER PERFORMANCE SHORT SLEEVE SHIRT -

WHEN YOU'RE UP FOR ANYTHING,
WEAR A SHIRT THAT DOES
EVERYTHING

D. VORTEX DAY RUCKER PERFORMANCE SHORT SLEEVE SHIRT

From getting you in shape for that elk hunt you've been dreaming about to keeping you cool running errands around town, the Vortex Day Rucker Performance Short Sleeve Shirt does it all. Built to perform with UPF 50 protection and moisture wicking fabric, it's also all about comfort, featuring pieced construction to fit you better. On its own or as a layer, meet your new favorite shirt.

120-01 | M-3XL



CROWN BLUE BLACK HEATHER OLIVE DRAB PICANTE

E. VORTEX 3 PANEL LOGO CAP

219045 | One size fits most.



- VORTEX HAMMERSTONE SHORT SLEEVE SHIRT -

WE TRIED:
THE KITCHEN SINK
WOULDN'T FIT

F. VORTEX HAMMERSTONE SHORT SLEEVE SHIRT

As useful as it is good looking, the Hammerstone is a tool that does it all. Hidden chest zipper pocket? Yup. Hidden button-down collar to keep your collar locked down? You got it. Chamois cloth in the bottom hem built to our exacting specs so it's safe to use on your Vortex® optics? You better believe it. On top of that, you get two front pockets, rip stop fabric to stop tears in their tracks, mechanical stretch built into the fabric, hidden rollup sun collar, and UPF 50 protection. Whether you want to hunt, shoot, fish, or hike, you're going to look good doing it.

120-06 | M-3XL

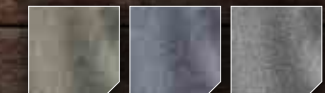

KALAMATA CROWN BLUE CASTLEROCK

TAKE YOUR BEST SHOT



THE GROWTH OF COMPETITIVE SHOOTING

Competitive shooting in America has come a long way since its origins in the early 19th century: Some of the first competitions were “Turkey Shoots”—where competitors shot at a turkey tied to the ground, winning it if they killed it—and “Rifle Frolics,” which sound like people running through meadows full of wildflowers with muskets in their hands. But things quickly got serious after the American Civil War, when poor marksmanship on both sides of the Mason-Dixon caused organizations like the NRA to start sponsoring events to ensure civilians could handle firearms. Even back then, the competitions were wildly popular.

Today’s competitive shooting offers something for every interest, from close-quarters pistol work to extreme long-range rifle contests. And while an old-fashioned shoot might have won you a turkey, modern

competitions can win you some serious bread, with purses upwards of \$50,000 for some tournament winners.

But most shooters compete simply for the love of the sport, and with thousands of sanctioned events in the US each year—and divisions that make shooting sports accessible for every level of shooter—competitive shooting is growing fast: Over 50 million Americans participate each year. And with the variety of shooting sports available, there’s one to fit your needs.

We asked three Team Vortex members with serious skills to tell us more about their favorite shooting sport, and how interested shooters can get started.

PRS

THE SWEET SOUND OF RINGING STEEL

Precision rifle shooting is the perfect blend of speed and accuracy, with shooters engaging targets from 10 yards away out to a mile in an action-packed test of nerve and ballistic know-how. If you think that sounds like a blast, you’re not alone: From 164 competitors in 2012, the officially sanctioned PRS (Precision Rifle Series) grew to over 5,000 shooters in 2018, with hundreds of local, regional, and national events supporting shooters of all ages and skill levels.

A combination of staged military, law enforcement, and practical hunting scenarios, precision rifle competitors are put into situations challenging their bodies and minds, from long-distance shots from less than ideal positions to a running clock, forcing them to think and shoot on the fly.

Nick Laufenberg
Customer Engagement Specialist, Dealer Sales
PRS Competitor

What about precision rifle shooting appeals to you?

I’ve always been an analytical person... I enjoy gathering data and putting that data to use. What happens when a bullet leaves the muzzle... what happens when a bullet drops below the sound barrier... how a bullet is affected by wind... those things are all really interesting to me. Plus, PRS is the 3-Gun of precision shooting: You’re shooting from odd positions, you’re being timed, you have targets of different sizes. Some events, you’re carrying everything you need for the shoot on your back, so you’re doing all this with a 40-pound ruck and 200 plus rounds of ammo.

If someone is interested in trying precision rifle shooting, how can they get started?

A local or regional match is a great place to start. You’ll be working with people who are more at your level of knowledge, and the pro-level shooters who do come to those events are the nicest, most generous people you can imagine.

When you go to your first match, you’re going to have 50 people who want to help you out; everyone there wants to see you succeed. It’s funny, because your competitors are also the ones teaching you, and they do it with open arms.

What’s the fastest way to improve?

Buy yourself a .22 or a .223—a .308 is probably even better, but it is more expensive to shoot—and practice. A .22 LR is my favorite training tool. With a .22, that bullet starts out at a lower velocity, so it takes longer to exit the barrel. That means your follow through must be perfect. If you learn good habits on a .22, they’ll carry over to larger calibers. The .308 is great too because the additional recoil really teaches you how to drive your rifle.



What optic do you recommend for someone just starting out in the sport?

Viper® PST™ Gen II 5-25x50 FFP with EBR-7C reticle.

While the PST™ Gen II may cost more than your average entry-level riflescope, it’s always worthwhile to purchase the absolute best optic you can afford. You need optical quality and a larger field of view. When you miss, you need to be able to see your miss, and when you hit, you need to know where that impact was, which is a question of resolution. If you miss, and don’t see it, that shot was a complete waste. A first focal plane is very important, and a good, repeatable turret system. Having a zero stop, too, means you can move between stages quickly, and always be sure of getting back to your zero. It costs more than an entry-level scope, but you’ll learn faster with a better optic.

What optic do you recommend for the more advanced precision rifle shooter?

Razor® HD Gen II 4.5-27x56 with EBR-7C reticle.

I have one on almost every one of my rifles. I don’t need 4.5 power, but a top end of 27 is enough magnification at basically any practical distance. It has the resolution I need, and a tactile revolution system on the turrets, which means I can just reach up and feel how many revs up I am without having to look. We’re also really hard on our optics in this game. I’ve seen people jam rifles into props, forcing a scope into position, then they’ll clear that stage and move on to clear another.

F-CLASS

GET YOUR PHD IN DOWNRANGE IMPACT

At a glance, it seems like F-Class should be easier. You don't get the awkward shooting positions of PRS competitions, and you don't have the physical challenges of running stages in 3-Gun. In fact, you only shoot prone at known distances. But try hitting a five-inch X ring ten football fields away in variable wind and you'll get it: There's a lot more to this cerebral shooting sport than meets the eye.

From fickle winds that get stronger, weaker, and even change direction between you and your target, to varying levels of mirage to further confuse things, F-Class has a set of challenges all its own. But it's also a sport chock full of divisions that welcome shooters of all ages and skill levels, from brand new to the shooter who wants to deep-dive into reloading, DOPE charts, and building the fully custom rig of their dreams.



Ian Klemm

Director of Federal Contracting, Engineering
Two-time F-Class National Champion

What about F-Class appeals to you?

The great thing about F-Class is that it trains and tests your ability to put a bullet exactly where you want, regardless of the wind. It's not good enough to hit the target; you're measured on your ability to hit the exact center of the target shot after shot by reading and compensating for the ever-changing wind. A championship can be four days of shooting. It becomes an endurance competition. Who slept well? Who stayed hydrated so their eyes didn't dry out while they were trying to read mirage? Who fought for every single point they could get?

It's a timed contest, but not in the sense that 3-Gun is a timed contest — It's not a race, and you don't get credit for finishing first. What you have is a given amount of time to shoot your sighting shots and your shots for record. Part of the competition is making better choices than your opponents about when to shoot. If a big wind comes through, you can choose to wait, but you still need to get all your shots for record inside of that time limit.

It comes down to how well can you get your rifle to shoot, how well can you make your own ammunition to suit that rifle, and how well can you read atmospheric. Those who are detail oriented when it comes to their equipment, hand loading, and shooting technique will find F-Class really rewarding.

If someone is interested in trying F-Class, how can they get started?

There's a lot of local club-level matches around the country to participate in. Each of these clubs will have a couple shooters that are competitive on the National level and those are great people to watch and learn from. Usually at club events, people are bringing their one centerfire rifle, not necessarily a gun built for F-Class. And those types of events can make accommodations to be more inclusive of new shooters. They'll even do things like let someone with a handicap shoot off a bench, for example.

Don't invest in a special rifle right away. You can find out if you like F-Class shooting with whatever centerfire rifle you have; your hunting

rifle will work. You can also wait till the end of a match, and approach someone and ask if you can try their rifle. It's a very friendly culture, very open to new shooters who want to learn.

What's the fastest way to improve?

The best way to get better is to shoot an accurate .22 at a range where wind can influence the bullet — usually 100 yards. My personal performance was plateaued for a while, and then I started shooting .22 again. It helped me teach my subconscious to focus on more of the administrative aspects of shooting, and all of a sudden, my conscious mind has all this time to focus on the more critical aspects like reading the wind. But whether you choose to train with a centerfire or rimfire, it needs to be as accurate as possible so that the cause and effect information you gather about how the wind affects your shot is data you can trust.

What optic do you recommend for someone looking to get started in F-Class?

Viper® HST™ with VMR-1 MOA reticle. I'd recommend going with an MOA reticle. The scoring rings that are printed on the paper targets are actually measured in MOA, so using an MOA-based reticle avoids any confusion there.

You need second focal plane reticle because you're aiming at small features on a target that's very far away so you want a reticle that looks thin at high power. A first focal plane reticle, will look thick at high power, covering more of your target which will hurt your ability to take a fine aim point. Combine SFP reticle with a minimum top end magnification of 24 power, and you need no coarser than 1/4 MOA adjustments. And you need at least 35 minutes of elevation adjustment to get the slowest .308 out to 1,000 yards.

What optic do you recommend for the more advanced F-Class shooter?

The Golden Eagle® HD. I designed this scope a few years ago specifically for long-range, known-distance shooting. It has 1/8 MOA adjustments, and two reticles specifically designed for F-Class-type targets. It has very repeatable tracking, and it's a 15-60 powered optic. It also has a unique feature called an Aperture Stop Ring to lengthen depth of focus. Sometimes the most impactful mirage isn't the one right in front of your target, it's closer. With the ASR, you can read mirage closer to you.

3-GUN

SPEED FREAKS WELCOME

If you love a gunpowder-fueled adrenaline rush, action shooting sports will put a big old smile on your face. One of the fastest growing action shooting disciplines is 3-Gun, but it's not for the faint of heart. Not only must you master three separate weapons—pistol, shotgun, and modern sporting rifle—you need to be able to safely and quickly complete a course packed with challenging targets setup from one yard away to 500, and every distance in between. Plus, because course setup is up to the event director, every course you shoot will likely be different from any you've shot before, meaning every shoot is a new puzzle to solve at speed. Lots of lead, lots of ringing steel, and lots of fun.



Reuben Aleckson

Dealer Training and Customer Experience Manager
3-Gun National Champion

What about 3-Gun appeals to you?

One of the coolest parts about action shooting is there's a huge physical component. It's like a short distance sprint, but with guns. You're put in this dynamic environment where you're shooting from compromised positions. There's a ton of pressure, but I've never had the kind of adrenaline dump I feel when that buzzer goes off. Everything becomes very urgent. Then there's this huge rush of endorphins at the end of it, when you ask, "Did I clear everything?" and they say, "Yeah, you cleared it." It pushes your physical and mental abilities to the max.

It's such a tight community. It's the only sport I know of where you can be competing for tens of thousands of dollars, and still make sure to help your competitors because you know they'd help you.

If someone is interested in trying 3-Gun, how can they get started?

The best thing you can do is to actually go to a match. You can kind of see how things run and get a feel for the people and how they interact. The hardest part about going to a match, and this is a real thing, will be all the people coming up to you, trying to get you to shoot that day.

And don't fall for gear intimidation. Think about it like this: If you go to a NASCAR event and look at those cars, yeah, every one of them is hundreds of thousands of dollars. But if you go to the races at the county fair, it's going to be whatever car a guy had in his garage. At local 3-Gun events, guys'll have their duck hunting shotgun, their home defense pistol, and whatever AR they've got with a red dot on it. We like to say, "Run what you brung." And honestly, there will be an almost obnoxious number of people wanting to lend you gear. Just choosing to go is the hardest part; after that, everything gets easier because it's a community that wants you to have fun.

What's the fastest way to improve?

The fastest way to improve is repetition, and finding yourself a good mentor. Get repetition on the firearms you intend to compete with, but also getting a good mentor to make sure you're learning right. I've got people who will come to me and ask, "Why are my shots missing right?" Things like that. They can record themselves and we can sit down together and get them on the right track.

What optic do you recommend for someone looking to get started in 3-Gun?

Rifle: Strike Eagle® 1-6x24 AR-BDC Reticle.

On your rifle, a Strike Eagle® 1-6 is very easy to use, and it packs a lot of features into an optic that also has a great price point.

On a shotgun and pistol, you'll probably just run your iron sights.

What optic do you recommend for the more advanced 3-Gun shooter?

Rifle: Razor® HD Gen II-E 1-6x24 with JM-1 Reticle.

The Razor® 1-6 is the most used optic in 3-Gun. It was purpose-built for action shooting, for working out dynamic shooting scenarios, from close-in distances to farther out.

Pistol: Razor® Red Dot, 6 MOA.

Shotgun: Razor® Red Dot, 3 MOA.

It offers a very large viewing window and a very bright dot, and it's durable. You need all of that running 3-Gun.



RIFLESCOPES



RAZOR® HD AMG®

RIFLESCOPE

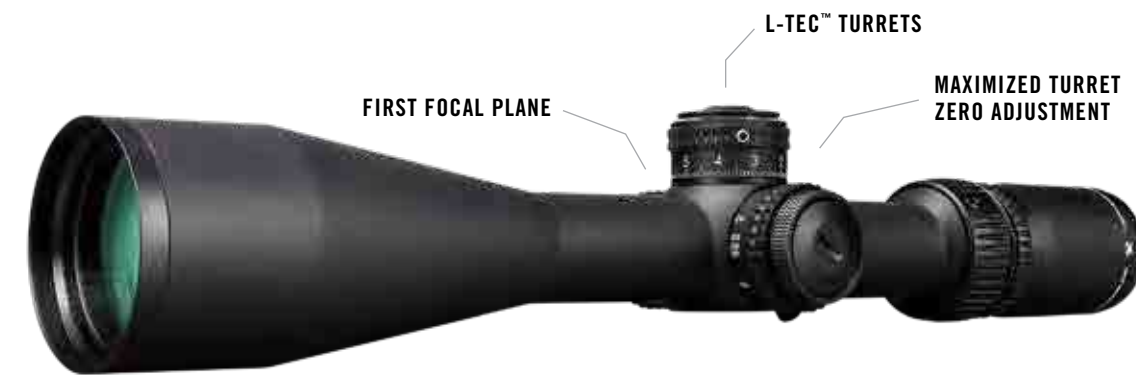

CARRIES LIGHT. HITS HARD.

The Razor® HD AMG® is ready to handle any mission, from long-range competition to tactical applications — and even open-landscape hunts — all with ultimate precision. Packed with long-range features like locking turrets, its integrated L-Tec™ zero stop, and an integrated locking illumination dial powering the first focal plane reticle, this workhorse still weighs just 28.8 oz. Rather than pursuing the more common 34mm tube, the Razor® HD AMG® relies on its 30mm tube to aid in weight reduction. The smaller tube offers a sleeker profile without significant compromise in internal adjustment or field of view.

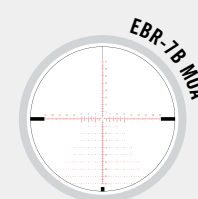
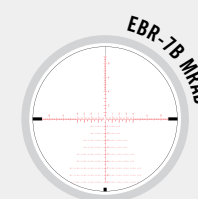

SPECS

SKU	MAGNIFICATION X OBJECTIVE LENS	RETICLE OPTIONS	WEIGHT	LENGTH	EYE RELIEF (MAX POWER)	FIELD OF VIEW @ 100 YARDS	TUBE SIZE	TURRET STYLE
RZR-AMG-5	6-24x50 FFP	EBR-7B MRAD	28.8 oz.	14.96"	3.6"	20.4' - 5.1'	30mm	L-Tec
RZR-AMG-4		EBR-7B MOA						

FEATURES

- ▶ HD OPTICAL SYSTEM
- ▶ XR™ PLUS LENS COATINGS
- ▶ PLASMA TECH
- ▶ ALO ALIGNMENT
- ▶ APOCHROMATIC
- ▶ ARMORTEK®
- ▶ ARGON GAS PURGED
- ▶ WATERPROOF
- ▶ FOGPROOF
- ▶ SHOCKPROOF

For a description of each feature, see page 6. For detailed reticle information, see pages 128-131 or visit our website.



RAZOR® HD GEN III

RIFLESCOPE



10X ZOOM RANGE
FIRST FOCAL PLANE



SWITCHVIEW THROW
LEVER INCLUDED

DAYLIGHT BRIGHT
ILLUMINATION

NOBODY EVER SAID YOU HAD TO FIGHT FAIR.

The next evolution of our wildly popular Razor® line, the Razor® HD Gen III 1-10x24 brings the highest level of first focal plane performance to those who demand the versatility of 1-10x power. Military, law enforcement, and competition shooters alike will love the clarity of an HD optical system and a crisp, illuminated reticle in a package that weighs the same as our 1-6x, but doesn't sacrifice any durability. A true 1x on the low end and daylight bright illumination for reliable performance in all conditions makes this a single solution for close-quarters and long-range.

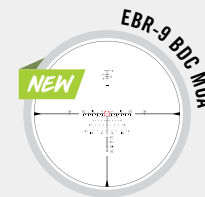

SPECS

SKU	MAGNIFICATION X OBJECTIVE LENS	RETICLE OPTIONS	WEIGHT	LENGTH	EYE RELIEF (MAX POWER)	FIELD OF VIEW @ 100 YARDS	TUBE SIZE	TURRET STYLE
RZR-11002	1-10x24 FFP	EBR-9 MRAD	21.5 oz.	10.10"	3.6"	116.0' - 11.7'	34mm	Low Capped
RZR-11001		EBR-9 BDC MOA						

FEATURES

- ▶ HD OPTICAL SYSTEM
- ▶ XR™ PLUS LENS COATINGS
- ▶ APOCHROMATIC
- ▶ ARMORTEK®
- ▶ ARGON GAS PURGED
- ▶ WATERPROOF
- ▶ FOGPROOF
- ▶ SHOCKPROOF

For a description of each feature, see page 6. For detailed reticle information, see pages 128-131 or visit our website.



RAZOR® HD GEN II

RIFLESCOPE



DIAL IN CASE OF EMERGENCY.

Tactical and competitive shooters looking for the optimal combination of features and optical quality have a clear go-to. The Razor® HD Gen II provides long-range shooters the advanced features needed to perform at the highest level, including locking turrets, the integrated L-Tec™ zero stop, and a first focal plane reticle for when you need to shoot quickly from any magnification.

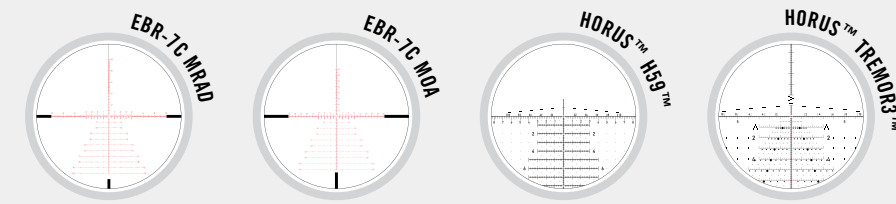

SPECS

SKU	MAGNIFICATION X OBJECTIVE LENS	RETICLE OPTIONS	WEIGHT	LENGTH	EYE RELIEF (MAX POWER)	FIELD OF VIEW @ 100 YARDS	TUBE SIZE	TURRET STYLE
RZR-42707	4.5-27x56 FFP	EBR-7C MOA	48.5 oz.	14.40"	3.7"	25.3' - 4.4'	34mm	L-Tec
RZR-42708		EBR-7C MRAD						
RZR-42709		Horus™ H59™						
RZR-42710		Horus™ Tremor3™						
RZR-31804	3-18x50 FFP	EBR-7C MOA	46.5 oz.	14.40"	3.7"	37.8' - 6.3'	34mm	L-Tec
RZR-31805		EBR-7C MRAD						

FEATURES

- ▶ HD OPTICAL SYSTEM
- ▶ XR™ PLUS LENS COATINGS
- ▶ PLASMA TECH
- ▶ APOCHROMATIC
- ▶ ARMORTEK®
- ▶ ARGON GAS PURGED
- ▶ WATERPROOF
- ▶ FOGPROOF
- ▶ SHOCKPROOF

For a description of each feature, see page 6. For detailed reticle information, see pages 128-131 or visit our website.



RAZOR® HD GEN II-E

RIFLESCOPE



ILLUMINATED CENTER DOT

ANODIZED STEALTH SHADOW FINISH



THE 'E' IS SILENT.

Perfect for the AR platform, the Razor® HD Gen II-E is the top-tier optical solution for short to medium range engagements. Nearly 1/4 pound lighter than the original Razor® HD Gen II 1-6x24, the "E" (Enhanced) model allows for quicker target transitions and less fatigue during long range days. It delivers a stunning level of clarity, resolution, color accuracy, light transmission, and edge-to-edge sharpness. True 1x is complimented by an ultra-forgiving eyepiece with generous eye relief for a HUD-like sight picture. The daylight bright illuminated center dot facilitates close-quarters target acquisition. Built like a tank on a 30mm, aircraft-grade aluminum tube, the Razor® HD Gen II-E features low profile capped windage and elevation turrets for streamlined performance.

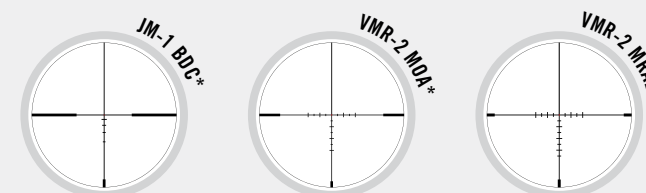

*Center dot illumination.

SPECS

SKU	MAGNIFICATION X OBJECTIVE LENS	RETICLE OPTIONS	WEIGHT	LENGTH	EYE RELIEF (MAX POWER)	FIELD OF VIEW @ 100 YARDS	TUBE SIZE	TURRET STYLE
RZR-16008		JM-1 MOA						
RZR-16010	1-6x24	VMR-2 MOA	21.5 oz.	10.10"	4.0"	115.2' - 20.5'	30mm	Low Capped
RZR-16009		VMR-2 MRAD						

FEATURES

- ▶ HD OPTICAL SYSTEM
- ▶ XR™ PLUS LENS COATINGS
- ▶ PLASMA TECH
- ▶ APOCHROMATIC
- ▶ ARMORTEK®
- ▶ ARGON GAS PURGED
- ▶ WATERPROOF
- ▶ FOGPROOF
- ▶ SHOCKPROOF

For a description of each feature, see page 6. For detailed reticle information, see pages 128-131 or visit our website.

RAZOR® HD

RIFLESCOPE



WHEN YOUR RIFLE NEEDS A TRAVEL AGENT.

It's simple: We built the Razor® HD so you can shoot farther than you ever thought possible. Purpose-built to go long, it offers the crisp image quality necessary to identify targets at extended range, while the 35mm, one-piece tube allows for 36 MRAD / 125 MOA of adjustment. No other scope in our line has this much travel, and thanks to the integrated mechanical RZR™ zero stop, you can dial all day knowing you'll have an accurate, repeatable return to zero. A glass-etched, first focal plane reticle makes for quick, easy holdovers, range estimations, or calls for correction on any magnification.

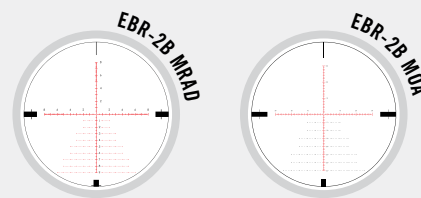

SPECS

SKU	MAGNIFICATION X OBJECTIVE LENS	RETICLE OPTIONS	WEIGHT	LENGTH	EYE RELIEF (MAX POWER)	FIELD OF VIEW @ 100 YARDS	TUBE SIZE	TURRET STYLE
RZR-52006	5-20x50 FFP	EBR-2B MRAD	37 oz.	15.80"	3.9"	22.5' - 5.8'	35mm	Tactical
RZR-52005		EBR-2B MOA						

FEATURES

- ▶ HD OPTICAL SYSTEM
- ▶ XR™ LENS COATINGS
- ▶ APOCHROMATIC
- ▶ ARMORTEK®
- ▶ ARGON GAS PURGED
- ▶ WATERPROOF
- ▶ FOGPROOF
- ▶ SHOCKPROOF

For a description of each feature, see page 6. For detailed reticle information, see pages 128-131 or visit our website.

WINNER OF BACK-TO-BACK F-CLASS F/TR LONG-RANGE NATIONAL CHAMPIONSHIPS.

GOLDEN EAGLE® HD

RIFLESCOPE



REDEFINE YOUR EFFECTIVE RANGE.

Specifically designed for F-Class and Bench Rest competition shooters, the Golden Eagle® HD is the winning edge you need. The 15-60x magnification range, ultra-precise 1/8 MOA adjustments, and extremely fine second focal plane reticle options help maximize precision on known-distance, long-range targets. All these features are complimented by an optical system that provides a super-sharp target picture and the ability to read mirage and other wind indicators accurately. Equally impressive, the Golden Eagle® HD weighs in at 29.5 ounces, helping shooters adhere to strict competition weight limits. When you're going for gold, go for the Golden Eagle® HD.

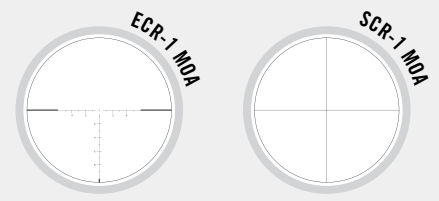

ASR (Aperture Stop Ring)
Broadens the depth of field allowing the shooter to more easily observe down-range mirage and other wind indicators while keeping the target in focus.



SPECS

SKU	MAGNIFICATION X OBJECTIVE LENS	RETICLE OPTIONS	WEIGHT	LENGTH	EYE RELIEF (MAX POWER)	FIELD OF VIEW @ 100 YARDS	TUBE SIZE	TURRET STYLE
TCS-1503	15-60x52	ECR-1 MOA	29.7 oz.	16.10"	3.9"	6.3' - 1.7'	30mm	Target
TCS-1501		SCR-1 MOA						

FEATURES

- ▶ HD OPTICAL SYSTEM
- ▶ XR™ PLUS LENS COATINGS
- ▶ PLASMA TECH
- ▶ APOCHROMATIC
- ▶ ARMORTEK®
- ▶ ARGON GAS PURGED
- ▶ WATERPROOF
- ▶ FOGPROOF
- ▶ SHOCKPROOF

For a description of each feature, see page 6. For detailed reticle information, see pages 128-131 or visit our website.



VIPER® PST™ GEN II

RIFLESCOPE



WHEN ALL ELSE FAILS, THIS WON'T.

The Viper® PST™ Gen II brings you all the features of elite, top-tier tactical optics at a fraction of the cost. The optical system delivers bright, crisp images across the zoom range with an impressive field of view for quicker target acquisition. Whether you're topping your door kicker or dialing precision long-range shots, there's a Viper® PST™ Gen II to fulfill your needs and exceed your expectations.

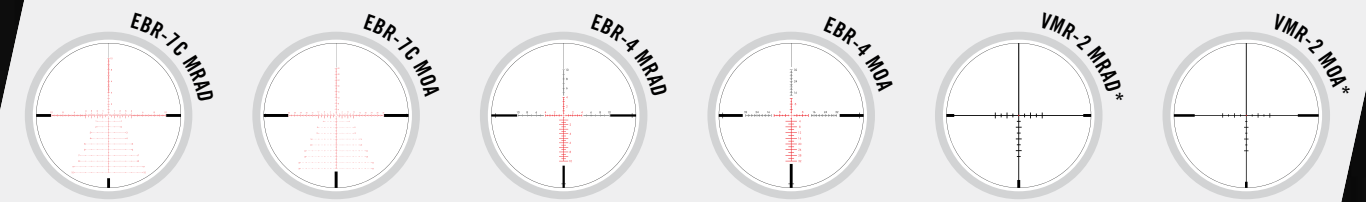

*Center dot illumination.

SPECS

SKU	MAGNIFICATION X OBJECTIVE LENS	RETICLE OPTIONS	WEIGHT	LENGTH	EYE RELIEF (MAX POWER)	FIELD OF VIEW @ 100 YARDS	TUBE SIZE	TURRET STYLE
PST-5259	5-25x50 FFP	EBR-7C MRAD	31.2 oz.	15.79"	3.4"	24.1' - 4.8'	30mm	Tactical
PST-5256		EBR-7C MOA						
PST-5251	5-25x50	EBR-4 MOA	31.2 oz.	15.79"	3.4"	24.1' - 4.8'	30mm	Tactical
PST-3159	3-15x44 FFP	EBR-7C MRAD	28.1 oz.	14.30"	3.4"	41.2' - 8.6'	30mm	Tactical
PST-3156		EBR-7C MOA						
PST-3151	3-15x44	EBR-4 MOA	28.1 oz.	14.30"	3.4"	41.2' - 8.6'	30mm	Tactical
PST-2105	2-10x32 FFP	EBR-4 MRAD	26.3 oz.	12.64"	3.2"	58.3' - 11.7'	30mm	Tactical
PST-2101		EBR-4 MOA						
PST-1607	1-6x24	VMR-2 MRAD	22.7 oz.	10.83"	3.8"	112.5' - 18.8'	30mm	Capped
PST-1605		VMR-2 MOA						

FEATURES

- ▶ XD™ OPTICAL SYSTEM
- ▶ XR™ LENS COATINGS
- ▶ ARMORTEK®
- ▶ ARGON GAS PURGED
- ▶ WATERPROOF
- ▶ FOGPROOF
- ▶ SHOCKPROOF

For a description of each feature, see page 6. For detailed reticle information, see pages 128-131 or visit our website.



VIPER® HST™

RIFLESCOPE



ONE SCOPE THAT DOES IT ALL.

Tree stands to mountain tops, bolt guns to ARs, the Viper® HST™ is at home wherever you are. Blending many of the best features from our incredibly popular Viper® PST™ and Viper® HS™ riflescopes, the Viper® HST™ is built on an ultra-strong 30mm, one-piece aluminum tube to deliver ample windage and elevation travel. An advanced optical system, highlighted by a 4x zoom range, provides magnification versatility and a forgiving eyepiece with increased eye relief, getting shooters on target quickly. Incredibly precise, repeatable, and durable tactical turrets built for dialing—along with its hashmark-based VMR-1 reticle—top this rifle scope's complete long-range performance features.

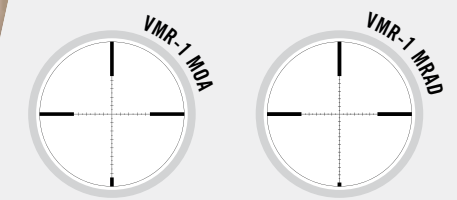

SPECS

SKU	MAGNIFICATION X OBJECTIVE LENS	RETICLE OPTIONS	WEIGHT	LENGTH	EYE RELIEF (MAX POWER)	FIELD OF VIEW @ 100 YARDS	TUBE SIZE	TURRET STYLE
VHS-4310	6-24x50	VMR-1 MRAD	22.6 oz.	15.41"	4.0"	17.8' - 5.1'	30mm	Tactical
VHS-4325		VMR-1 MOA						
VHS-4308	4-16x44	VMR-1 MRAD	20.8 oz.	13.33"	4.0"	27.4' - 7.4'	30mm	Tactical
VHS-4309		VMR-1 MOA						

FEATURES

- ▶ XD™ OPTICAL SYSTEM
- ▶ XR™ LENS COATINGS
- ▶ ARMORTEK®
- ▶ ARGON GAS PURGED
- ▶ WATERPROOF
- ▶ FOGPROOF
- ▶ SHOCKPROOF

For a description of each feature, see page 6. For detailed reticle information, see pages 128-131 or visit our website.



VIPER® HSLR™ / HS™

RIFLESCOPE



FIELD PROVEN. YOUR FREEZER WILL TESTIFY.

Ask us to pick one series of riflescopes as the go-to for just about any hunting or recreational shooting application and the answer is the Viper® HS™. Hunters and shooters looking for clear, crisp, and bright views with rock-steady performance would be hard-pressed to find a better rifle-topper for the money. Plus, you get the options you need: Take fully-capped turrets or choose the Viper® HSLR™, with its exposed elevation turret for quick dialing on long-range shots. Whether ringing steel at the range or filling the freezer, the Viper® HS™ series is ready for action.

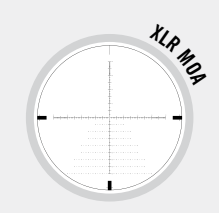

SPECS

SKU	MAGNIFICATION X OBJECTIVE LENS	RETICLE OPTIONS	WEIGHT	LENGTH	EYE RELIEF (MAX POWER)	FIELD OF VIEW @ 100 YARDS	TUBE SIZE	TURRET STYLE
Viper® HSLR™								
VHS-4315-LR	6-24x50 FFP	XLR MOA	22.4 oz.	15.41"	4.0"	17.8' - 5.1'	30mm	Capped Windage Tactical Elevation
VHS-4307-LR	4-16x50	Dead-Hold® BDC	21.4 oz.	13.56"	4.0"	27.4' - 7.4'	30mm	Capped Windage Tactical Elevation
Viper® HS™								
VHS-4307	4-16x50	Dead-Hold® BDC	20.4 oz.	13.60"	4.0"	27.4' - 7.4'	30mm	Capped
VHS-4305	4-16x44	Dead-Hold® BDC	18.4 oz.	13.41"	4.0"	27.4' - 7.4'	30mm	Capped
VHS-4303	2.5-10x44	Dead-Hold® BDC	16.5 oz.	12.00"	4.0"	47.0' - 10.9'	30mm	Capped

FEATURES

- ▶ XD™ OPTICAL SYSTEM
- ▶ XR™ LENS COATINGS
- ▶ ARMORTEK®
- ▶ ARGON GAS PURGED
- ▶ WATERPROOF
- ▶ FOGPROOF
- ▶ SHOCKPROOF

For a description of each feature, see page 6. For detailed reticle information, see pages 128-131 or visit our website.



VIPER®

RIFLESCOPE



EASY-ADJUST
TALL CAPPED TURRETS

PRECISION-GLIDE
ERECTOR SYSTEM



PROVEN IN THE ONLY LAB THAT MATTERS.

When you see the crystal-clear image quality, feel the precision turret dialing system, and experience the rugged dependability in the field, you'll understand why people rarely have just one Viper®. Whether you hunt the east coast or the west, or you just need a scope ready to consistently punch tight groups at the range, the Viper® is up to the task. The Precision-Glide Erector System uses premium components in the zoom lens mechanism to ensure smooth magnification changes under the harshest conditions. Must cost an arm and a leg, right? Nope. The Viper® is known for giving you that "more-than-what-you-paid-for" feeling.



SPECS

SKU	MAGNIFICATION X OBJECTIVE LENS	RETICLE OPTIONS	WEIGHT	LENGTH	EYE RELIEF (MAX POWER)	FIELD OF VIEW @ 100 YARDS	TUBE SIZE	TURRET STYLE
VPR-M-06MD	6.5-20x50 PA	Mil Dot	21.6 oz.	14.44"	3.1"	17.4' - 6.2'	30mm	Tall Capped
VPR-M-06BDC		Dead-Hold® BDC						

FEATURES

- ▶ XD™ OPTICAL SYSTEM
- ▶ XR™ LENS COATINGS
- ▶ ARMORTEK®
- ▶ ARGON GAS PURGED
- ▶ WATERPROOF
- ▶ FOGPROOF
- ▶ SHOCKPROOF

For a description of each feature, see page 6. For detailed reticle information, see pages 128-131 or visit our website.

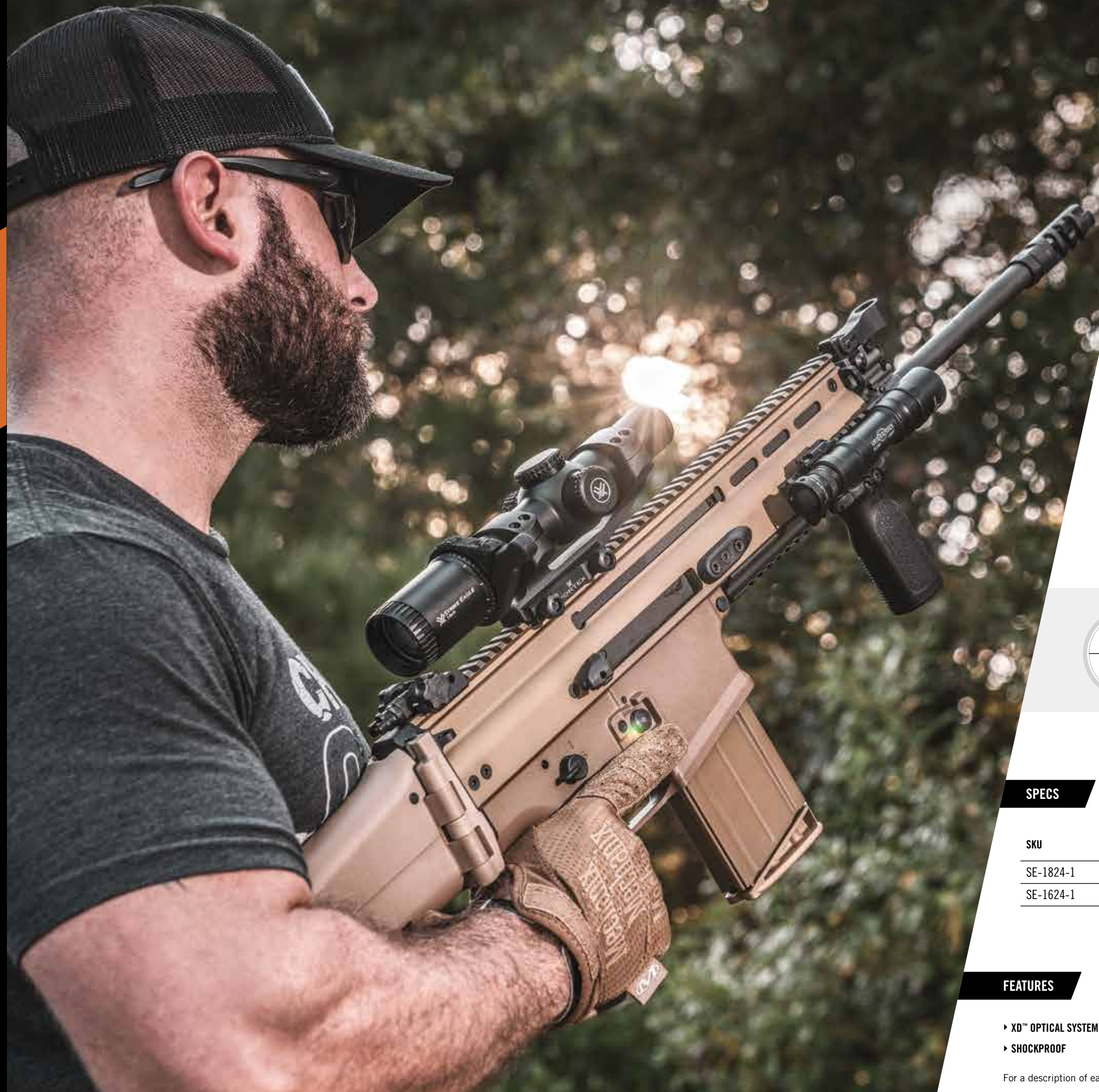

STRIKE EAGLE®

RIFLESCOPE



PREPARE FOR IMMEDIATE IMPACT.

Executing technical, short, and long-range shots requires a versatile riflescope with rock-solid quality. Strike Eagle® riflescopes boast powerful features in a trim, lightweight, durable package making them ideal for value-minded shooters, or those looking to get in the game without taking out a loan to do it. A true 1x on the low end adapts to a wide range of scenarios, letting shooters engage targets from point-blank to extended ranges. In any application, the Strike Eagle® ensures accurate, reliable, and repeatable performance — every time you squeeze the trigger.

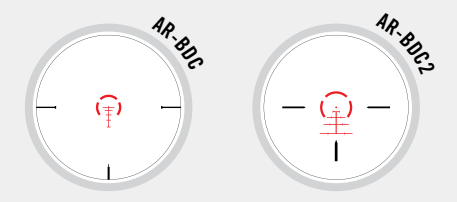

SPECS

SKU	MAGNIFICATION X OBJECTIVE LENS	RETICLE OPTIONS	WEIGHT	LENGTH	EYE RELIEF (MAX POWER)	FIELD OF VIEW @ 100 YARDS	TUBE SIZE	TURRET STYLE
SE-1824-1	1-8x24	AR-BDC2	16.5 oz.	10.00"	3.5"	116.5' - 14.4'	30mm	Capped
SE-1624-1	1-6x24	AR-BDC	17.6 oz.	10.50"	3.5"	116.5' - 19.2'	30mm	Capped

FEATURES

- ▶ XD™ OPTICAL SYSTEM
- ▶ FULLY MULTI-COATED LENSES
- ▶ NITROGEN GAS PURGED
- ▶ WATERPROOF
- ▶ FOGPROOF
- ▶ SHOCKPROOF

For a description of each feature, see page 6. For detailed reticle information, see pages 128-131 or visit our website.



DIAMONDBACK® TACTICAL

RIFLESCOPE



BEAT THE WIND, GRAVITY, AND YOUR PERSONAL BEST.

The Diamondback® Tactical puts the focus where it counts. Exposed turrets bring tracking performance previously unheard of at this price point, while its optical system delivers sharp image quality, even at long-range. Its simple design places you firmly in the driver's seat with the potential to take on 1,000 yards and beyond, all at a price that's easy to justify for new shooters, your training rifle, or experienced shooters looking for a back-to-basics optic on their fun gun. Mount a first focal plane model on a sweet-shooting rifle and you got a competition rig without breaking the bank.

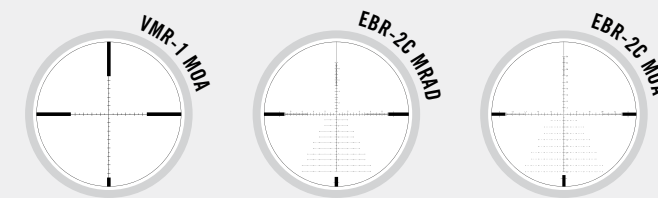

SPECS

SKU	MAGNIFICATION X OBJECTIVE LENS	RETICLE OPTIONS	WEIGHT	LENGTH	EYE RELIEF (MAX POWER)	FIELD OF VIEW @ 100 YARDS	TUBE SIZE	TURRET STYLE
DBK-10029	6-24x50 FFP	EBR-2C MRAD	24.6 oz.	14.28"	3.9"	18.0' - 4.5'	30mm	Tall Exposed Tactical
DBK-10028		EBR-2C MOA						
DBK-10027	4-16x44 FFP	EBR-2C MRAD	23.1 oz.	14.06"	3.8"	26.9' - 6.7'	30mm	Tall Exposed Tactical
DBK-10026		EBR-2C MOA						
DBK-10025	4-12x40	VMR-1 MOA	16.2 oz.	14.08"	3.9"	23.6' - 7.9'	1"	Tactical

FEATURES

- ▶ XD™ OPTICAL SYSTEM
- ▶ FULLY MULTI-COATED LENSES
- ▶ NITROGEN GAS PURGED
- ▶ WATERPROOF
- ▶ FOGPROOF
- ▶ SHOCKPROOF

For a description of each feature, see page 6. For detailed reticle information, see pages 128-131 or visit our website.

DIAMONDBACK®

RIFLESCOPE



AIRCRAFT-GRADE ALUMINUM
CONSTRUCTION



GREATNESS RUNS IN THE FAMILY.

You know you love it — that “I-just-got-more-than-I-paid-for” feeling — and the price-to-performance ratio for the Diamondback® will put a big ol’ smile on your face. It’s a classic, with image quality, build quality, and overall turret feel that means you don’t have to settle for blah performance out of an affordable optic. A variety of configurations and a fast-focus eyepiece give you speed and versatility, and at this price, you can afford to spend more time in the woods.



SPECS

SKU	MAGNIFICATION X OBJECTIVE LENS	RETICLE OPTIONS	WEIGHT	LENGTH	EYE RELIEF (MAX POWER)	FIELD OF VIEW @ 100 YARDS	TUBE SIZE	TURRET STYLE
DBK-04-BDC	4-12x40	Dead-Hold® BDC	14.6 oz.	12.00"	3.1"	32.4' - 11.3'	1"	Capped
DBK-03-BDC	3.5-10x50	Dead-Hold® BDC	16.2 oz.	12.50"	3.3"	35.8' - 13.5'	1"	Capped
DBK-M-01P	3-9x40	V-Plex	14.4 oz.	11.61"	3.3"	44.6' - 14.8'	1"	Capped
DBK-01-BDC		Dead-Hold® BDC						
DBK-RIM	2-7x35 Rimfire	V-Plex	14.2 oz.	11.60"	3.1"	64.3' - 19.3'	1"	Capped
DBK-08-BDC	1.75-5x32	Dead-Hold® BDC	12.8 oz.	10.20"	3.5"	68.3' - 23.1'	1"	Capped

FEATURES

- ▶ XD™ OPTICAL SYSTEM
- ▶ FULLY MULTI-COATED LENSES
- ▶ ARGON GAS PURGED
- ▶ WATERPROOF
- ▶ FOGPROOF
- ▶ SHOCKPROOF

For a description of each feature, see page 6. For detailed reticle information, see pages 128-131 or visit our website.



CROSSFIRE® II

30MM TUBE RIFLESCOPE



LAY DOWN THE LAW FROM DOWNTOWN.

With a scope offering as much variety as the Crossfire® II, you get options, options, and more options to match your needs. A 30mm tube diameter, 4x zoom, and incredibly versatile, top-end magnification makes this scope the perfect choice for an endless list of rifle-topping tasks. Exceptionally clear, fully multi-coated optics and superior build quality at this price will leave you scratching your head. It's everything you'd expect from the Crossfire®, and purpose-built for your needs.

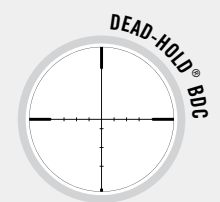
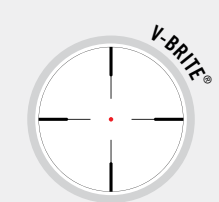

SPECS

SKU	MAGNIFICATION X OBJECTIVE LENS	RETICLE OPTIONS	WEIGHT	LENGTH	EYE RELIEF (MAX POWER)	FIELD OF VIEW @ 100 YARDS	TUBE SIZE	TURRET STYLE
CF2-31045	6-24x50 A0	Dead-Hold® BDC	23.6 oz.	14.50"	4.0"	17.3' - 4.4'	30mm	Capped
CF2-31039	4-16x50 A0	Dead-Hold® BDC	23.6 oz.	14.37"	3.7"	25.0' - 3.7'	30mm	Capped
CF2-31049	3-12x56 A0	V-Brite®	21.1 oz.	13.46"	3.5"	36.7' - 9.2'	30mm	Capped
CF2-31037	1-4x24	V-Brite®	14.8 oz.	9.61"	4.0"	96.1' - 24.1'	30mm	Capped

FEATURES

- ▶ SD OPTICAL SYSTEM
- ▶ FULLY MULTI-COATED LENSES
- ▶ NITROGEN GAS PURGED
- ▶ WATERPROOF
- ▶ FOGPROOF
- ▶ SHOCKPROOF

For a description of each feature, see page 6. For detailed reticle information, see pages 128-131 or visit our website.



CROSSFIRE® II

1 INCH TUBE RIFLESCOPE



HUNT HIGH. HUNT LOW. HUNT HARD.

The clear, tough, and bright optical quality of our popular Crossfire® II line is designed to make similarly priced riflescopes look downright silly. Long eye relief, a fast-focus eyepiece, fully multi-coated lenses, and resettable MOA turrets are hallmarks of the series, not to mention a price point that will leave you plenty of cash to hit the range and the woods in style. Go ahead. Take one for a spin and see what you've been missing.

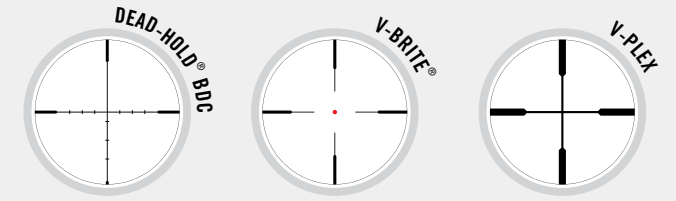

SPECS

SKU	MAGNIFICATION X OBJECTIVE LENS	RETICLE OPTIONS	WEIGHT	LENGTH	EYE RELIEF (MAX POWER)	FIELD OF VIEW @ 100 YARDS	TUBE SIZE	TURRET STYLE
CF2-31033	6-18x44 AO	Dead-Hold® BDC	19.6 oz.	13.78"	3.7"	15.2' - 5.2'	1"	Capped
CF2-31029		V-Brite®	20.6 oz.					
CF2-31023	4-12x50 AO	Dead-Hold® BDC	20.6 oz.	14.30"	3.9"	25.7' - 8.4'	1"	Capped
CF2-31019	4-12x40 AO	Dead-Hold® BDC	19.2 oz.	13.60"	3.9"	24.7' - 8.4'	1"	Capped
CF2-31015	4-12x44	Dead-Hold® BDC	17.2 oz.	13.15"	3.9"	24.7' - 8.4'	1"	Capped
CF2-31013		V-Plex						
CF2-31011	3-9x50	Dead-Hold® BDC	18.4 oz.	12.80"	3.8"	32.0' - 12.9'	1"	Capped
CF2-31027		V-Brite®	18.6 oz.					
CF2-31005	3-9x40	V-Plex	15.0 oz.	11.86"	3.8"	34.1' - 12.6'	1"	Capped
CF2-31007		Dead-Hold® BDC						
CF2-31025		V-Brite®	16.2 oz.					
CF2-31002	2-7x32 Scout	V-Plex	12.0 oz.	10.71"	9.5"	18.3' - 5.2'	1"	Capped
CF2-31003	2-7x32	Dead-Hold® BDC	14.3 oz.	10.71"	3.9"	42.0' - 12.6'	1"	Capped
CF2-31001		V-Plex						
CF2-31001R	2-7x32 Rimfire	V-Plex	14.3 oz.	10.71"	3.9"	42.0' - 12.6'	1"	Capped

FEATURES

- ▶ SD OPTICAL SYSTEM
- ▶ FULLY MULTI-COATED LENSES
- ▶ NITROGEN GAS PURGED
- ▶ WATERPROOF
- ▶ FOGPROOF
- ▶ SHOCKPROOF

For a description of each feature, see page 6. For detailed reticle information, see pages 128-131 or visit our website.

RIFLESCOPE ACCESSORIES

ACCESSORIES

RIFLESCOPES



PRO SERIES RIFLESCOPE RINGS

The finishing touch for your rifle and optic combination, Pro Series Rings combine rock-solid reliability and strength with high quality machining to ensure accuracy and consistency. Streamlined, lightweight, and durable, these rings use four T-25 Torx-style socket cap screws for secure mounting.

30mm Low PR30-L / Medium PR30-M / High PR30-H / Extra High PR30-XH
1-Inch Low PR1-L / Medium PR1-M



PRECISION MATCHED RINGS

Held to a higher standard and built tough, these rings are machined with certified USA 7075 T6 billet aluminum to an extremely tight tolerance of .0005 inches using a precision Computer Numeric Controlled (CNC) mill.

35mm .95in. PMR-35-95 / 1.00in. PMR-35-100 / 1.26in. PMR-35-126
34mm .92in. PMR-34-92 / 1.00in. PMR-34-100 / 1.10in. PMR-34-1.1
 1.26in. PMR-34-126 / 1.45in. PMR-34-145
30mm .87in. PMR-30-87 / .97in. PMR-30-97 / .97in. Weaver PMR-30-97-W
 1.26in. PMR-30-126 / 1.45in. PMR-30-145
1-Inch .76in. Weaver PMR-01-76-W



PRECISION QUICK RELEASE EXTENDED CANTILEVER MOUNT

Purpose-built to get your AR on target, this quick release cantilever mount is designed for mounting telescopic sights with 30mm tubes onto a flat-top style AR-15 rifle. This cantilever mount's offset positions the scope in a forward location, providing correct eye relief and head placement when used on an AR-15.

30mm CM-404



PRO EXTENDED CANTILEVER MOUNT

If these mounts make you think of freedom it's probably because they're made right here in the USA. These extended cantilever mounts are available in 34mm, 30mm, and 1-inch tube sizes and provide the correct height and forward placement for proper scope mounting.

34mm CVP-34 / **30mm** CVP-30 / **1-Inch** CVP-1



HUNTER RINGS

Simple and reliable, Hunter Rings mount to a Picatinny or Weaver-type rail. The standard, 2-screw rings are a nice match for general hunting setups when value and reliability are crucial. Made from aircraft-grade 6061-T6 aluminum for optimum strength.

30mm Low 30MRNG-L / Medium 30MRNG-M / High 30MRNG-H
1-Inch Low RING-L / Medium RING-M / High RING-H



PRECISION EXTENDED CANTILEVER MOUNT

The options, and precise machining, you need to get that just-right fit. Available in 30mm, 34mm, and 35mm with options for 20 MOA cant, these extended cantilevers have all the same features as our Precision Matched Rings, and are designed for mounting scopes with a forward location, providing correct eye relief and head placement.

35mm CM-535 / **34mm** CM-534 / **34mm 20 MOA** CM-534-20
30mm CM-530 / **30mm 20 MOA** CM-530-20



SPORT CANTILEVER RIFLESCOPE MOUNT

Get more comfort and more accuracy out of your AR. Vortex® cantilever ring mounts provide the correct height and forward placement for proper scope mounting on flat-top ARs. Available for 1-inch and 30mm tubes in 2-inch or 3-inch offset.

30mm 2-inch offset CM-202 / 3-inch offset CM-203
1-Inch 2-inch offset CM-102 / 3-inch offset CM-103



DEFENDER® FLIP CAP

Rifle ranges the world over are littered with broken flip caps, but this is one cap you won't see in the ol' flip cap boneyard. Virtually indestructible, it fits snugly on nearly all Vortex® riflescopes, and features a snap flat spring that keeps your line of sight unobstructed. The E-10 cap has three stop positions. The first is vertical, the second at 45°, and the third at 90° to lay flat.



TORQUE WRENCH MOUNTING KIT

Installing and maintaining precision gear takes precision tools, and this is the one kit you'll need to keep your zero safe. Adjustable in 1 in./lb. increments, this tool is easy to read, simple to set, and offers fast, accurate torque whenever and wherever you need it.



SUNSHADE

Prepare for every shooting scenario and reduce glare and sun reflection off the objective lens by adding a 4-inch sunshade. Available for select Viper® (44mm and 50mm) and Diamondback® Tactical riflescopes (40mm).

Diamondback Tactical 40mm DBK-SS4
Viper 50mm 50MM-V-SHADE
Viper 44mm 44MM-V-SHADE



SWITCHVIEW THROW LEVER

46mm SV-5 / **44mm** SV-4 / **49mm** SV-3 / **44mm** SV-2



LO PRO BUBBLE LEVEL

34mm LBL-34 / **30mm** LBL-30 / **1-Inch** LBL-1



BUBBLE LEVEL

35mm BL35 / **34mm** BL34
30mm BL30 / **1-Inch** BL1



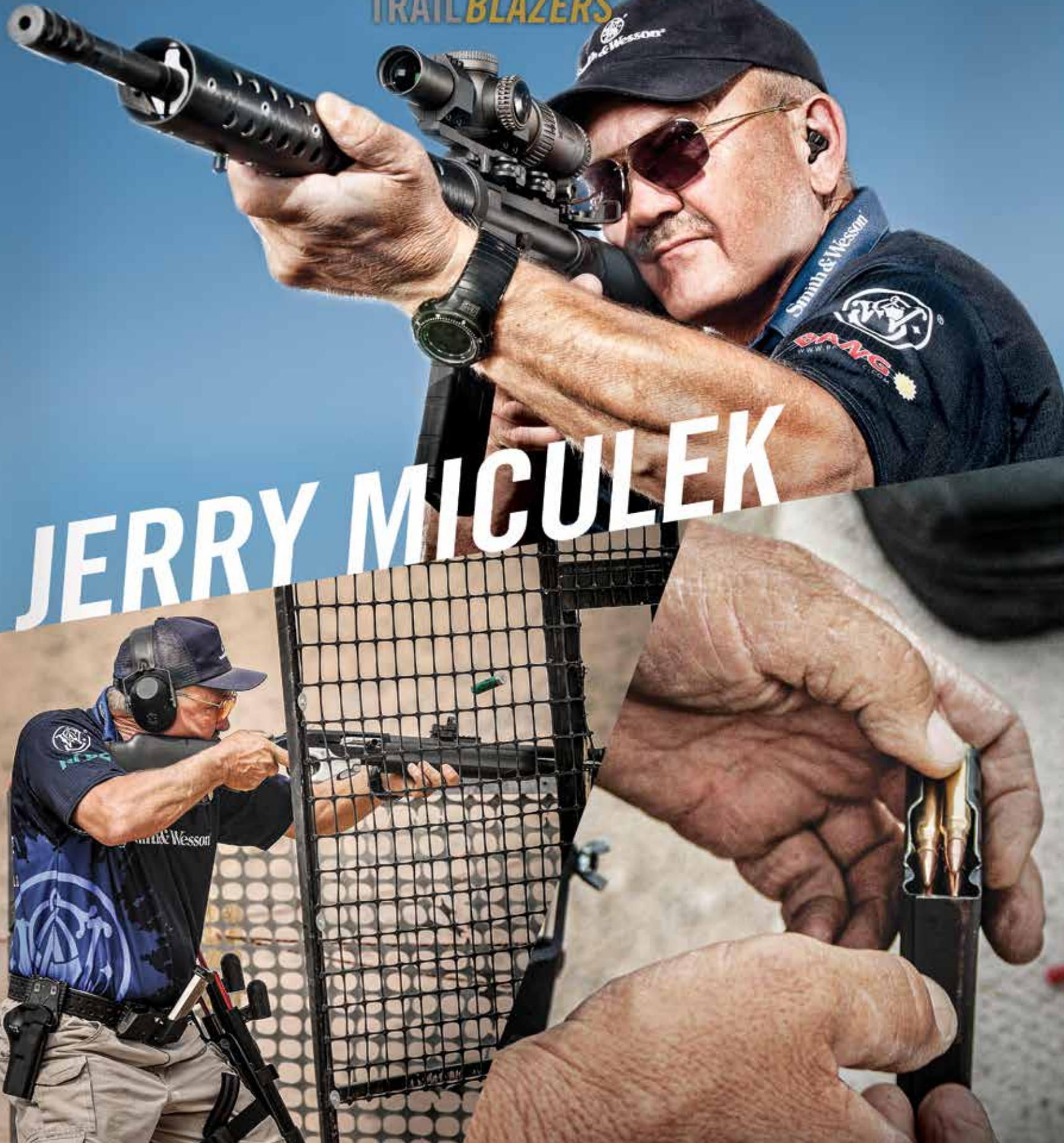

HANDIWORK

THE PERFECT WELDING WIRE, PINKY SHOOTING, AND BEING IN THE RIGHT PLACE AT THE RIGHT TIME WITH JERRY MICULEK

If you ever get the chance to shake Jerry Miculek's hand at one of the dozens of conventions, shows, and competitions he attends each year, be prepared: His hands have a strength totally at odds with his soft-spoken, Louisiana accent. And no wonder: When you've shot in the neighborhood of 2.5 million rounds of ammunition in your life, like Miculek has, recoil has a way of turning your hands into vice grips. "I think that's something like 22 tons of lead," Miculek said. "I was just looking this morning, and I've shot about 42,000 rounds this year. And it hasn't been a very busy year." He laughs. "Still. It keeps me out of trouble, I guess."

Miculek is one of the most prolific competitive shooters in America, and currently holds five sanctioned world records. While he built his name on speed shooting with revolvers — he's emptied a five-shot revolver into a target the size of a playing card in .57 seconds — he also holds records for shooting stunts that'd make even a hardened range junkie shake their head. He put five rounds on target out of a 500-magnum revolver in 1.14 seconds. He hit a target 200 yards away...with a .357 magnum...held upside down...while pulling the trigger with his pinky. If there's ever a Mount Rushmore built for competitive shooters, you'd see his face carved in that stone.

But it wasn't always like that for Miculek, now 65 and still competing. Self-taught, and the third-born of five boys, he fell in love with shooting and hunting at a young age. "We were always shooting something when we were kids. BB guns, pellet guns," Miculek said. That's also when he learned to work with his hands, and to rely on himself when it came to fixing things. "When I was young, my dad instilled in me, 'If you own it, you better be able to work on it.' We were five boys in the family, and my father bought us an old, '64 Plymouth and said, 'If you wanna' ride, you better learn to take care of it.' So we learned to be mechanics. We were rebuilding engines and lawnmowers and building boats before I graduated out of high school."

Honing his shooting skills at the local dump for years, the competition bug finally bit him in 1972. "I read an article in the American Rifleman — the September 1972 edition, I think it was — and it had a gentleman by the name of Ed McGivern on the cover, who was a revolver guy. He was the fastest revolver guy, had a world record at the time for firing five shots in 45/100 of a second. So that got me interested in shooting revolvers. We bought some guns and started shooting."

From the beginning, Miculek loved to shoot fast. He said, "Everything is speed related in America. That's what makes the wheel go 'round. The fastest cars, the fastest jets, the fastest boats. Faster shooting just kind of fit into the scheme of things for me. I wanted to go bigger and faster than anybody'd gone before." And another thing about speed shooting appealed to Miculek. "There's no perfect score in speed shooting. You just try to go faster than the other guy. It's pretty much only limited by how fast you can pull the trigger."

Shooting was a passion, but not yet his job. To keep shooting affordable, Miculek favored revolvers, where he could always get his brass back, and did all his own reloading. "We used to cast our own bullets and do the reloading work; when I was starting out, that's the only way we could afford it. Scrounging scrap lead off tire weights in the junkyard, and melting down lead sheathing." He also worked in a local fertilizer plant, where he was a multi-craft mechanic and welder, responsible for fixing whatever broke.

He carried that talent home, too. "I had a '72 Ford Bronco. And it was pretty beat up and rotted out by the time I got it in '74. I was able to find another one in a junkyard in New Orleans, and I got the back half off it. So, I cut the back half of mine off that was all rusted out and I welded that good back half onto mine. Just acetylene welded it with coat hangers." Coat hangers? "They work extremely well. You can do a lot of stuff with a coat hanger. It's almost a perfect welding wire. My mom didn't like it, though. I think I used just about every one she had."

Four years after starting to shoot in earnest, Miculek started putting his skills on the line against other shooters. He said, "A local guy held a practical shooting match in '76, so that's the first competition I ever shot. I ended up winning it, actually."

Since then, Miculek has racked up over 100 national and world shooting titles. He's built up a YouTube presence that now boasts over 1 million subscribers. But one thing hasn't changed: His love of working with his hands. Miculek is still his own gunsmith. He's still the caretaker of his own 143-acre farm, mowing 15-20 acres to keep his ranges open. And, he's still keeping up with all the work life throws his way. "The other morning I woke up and a bunch of wild hogs had gotten into my yard and broke a water line while they were rooting around," he said, and laughed. "Just another day. I had to go and find the leak and fix it. They were extremely destructive this time. I put a contract on them. I got a thermal scope, and they'll be out in the open one of these nights and it'll be payback."

Between competitions and appearances, Miculek keeps himself busy with dozens of projects, including working on his guns. "There's always something laying on the bench. I'm always working on something. It's the nice thing about the AR platform. It's like a tinkerer's dream. Anybody with a couple tools can build a rifle. It's like a tinker toy for adults." He's also regularly producing content for his YouTube channel, which he uses as an opportunity to share his passion for shooting. "A big part of it is just getting people interested in firearms. Guns get a bad rap, but it's just like any other tool in the toolbox: It's only as deadly or as safe as what you make it. Some of it is instructional, some of it is safety, some of it is just having fun. Rapid fire, blowing stuff up like when we were kids. Everybody likes to blow stuff up."

In the near future, Miculek wants to do more work with shotguns, possibly even chasing a few world records. And, as much as he credits decades spent shooting, drilling, and learning to shoot faster, he credits good luck for having the opportunity to chase his passion. "In my heart, I always wanted to do this. I always admired people who shot and shot well. Subconsciously, you're aiming to live a certain life. But you just do; you just keep doing what you love. A lot of things, you just have to be standing in the right place at the right time. Not necessarily the best or the brightest, but when a door opens, you got to step through it."



Mike T. - Customer Service
1-608-826-6277 EXT. 1277

FOR THESE GUYS, GOING THE EXTRA MILE
**MEANS TAKING IT
ONE STEP AT A TIME.**

No matter how long it takes, our team of experts takes the time to get you back to shooting, whether that means going through proper start-to-finish mounting technique, or getting your product repaired or replaced.



**UNCONDITIONAL. UNLIMITED.
LIFETIME WARRANTY.**

Vortex® will repair or replace the product. Absolutely free—no matter the cause.

Does not cover loss, theft, deliberate damage, or cosmetic damage that does not hinder the performance of the product.



RED DOTS



RED DOTS



RAZOR® AMG® UH-1®

HOLOGRAPHIC SIGHT

STEALTH SHOOTER SIGNATURE

MICRO USB PORT (NOT SHOWN)



LARGE FIELD OF VIEW

INTEGRATED QUICK RELEASE MOUNT

HE WHO SHOOTS FIRST, SHOOTS LAST.

When choosing your close-quarters optic, “close enough” doesn’t cut it. Intuitive, rugged, and the definition of reliable, Razor® AMG® UH-1® offers a revolutionary holographic system that gives you the impressive sight picture and distortion-free image of a holographic sight with the energy efficiency and durability of a red dot. With an ultra-clean sight picture and the incredibly fast EBR-CQB reticle, the UH-1® delivers all the features you need to take control of any close-quarters engagement.

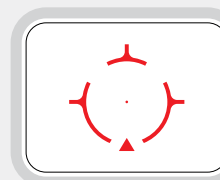

EBR-CQB RETICLE

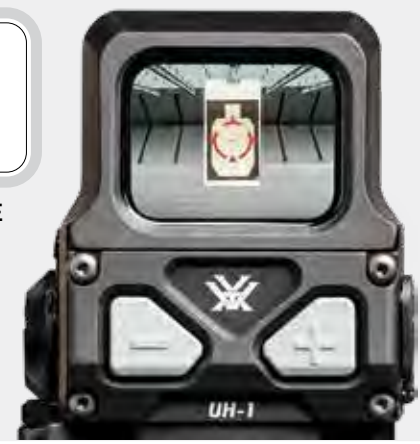

The clean, highly versatile, purpose-built reticle creates optimal target engagement in a wide range of scenarios.

FHQ™ Technology
Fusion Hologram with Quantum Well Light Control (FHQ) Technology virtually eliminates stray light emissions for stealth shooter signature in low light and prevents eyepiece glare common to other holographic sights.

SPECS

SKU	MAGNIFICATION	RETICLE COLOR	WEIGHT	LENGTH	EYE RELIEF	DOT SIZE	BATTERY
RZR-AMG-3	1x	Bright Red	11.8 oz.	3.6"	Unlimited	1 MOA	CR123A* LFP123A**

*Included. **Rechargeable option, sold separately.

FEATURES

- ▶ XR™ PLUS LENS COATINGS
- ▶ ARMORTEK®
- ▶ ARGON GAS PURGED
- ▶ WATERPROOF
- ▶ FOGPROOF
- ▶ SHOCKPROOF

For a description of each feature, see page 6. For detailed reticle information, see pages 128-131 or visit our website.



SPARC® AR

RED DOT

VORTEXOPTICS.COM



SPARC® AR

RED DOT



NOW WITH

LONGER BATTERY LIFE & NIGHT-VISION COMPATIBILITY

12-HOUR AUTO SHUTOFF

REAR-FACING ILLUMINATION CONTROL (12 ILLUMINATION SETTINGS)

BECAUSE A DEAD BATTERY CAN RUIN MORE THAN RANGE DAY.

Looking for the one optic you need to max your AR's effectiveness in any environment? The SPARC® AR features compact, rugged construction with a lightweight form-factor and 50,000 hours of battery life. And to make that battery last even longer, we've built in an auto shutoff. The 2 MOA dot is as easy as point and shoot — quick to acquire in close-quarters, but fine enough for pin-point accuracy at extended ranges. Plus, it's night-vision compatible on the two lowest illumination settings. A unique, integrated base is hassle-free on any AR, or similar platform, and rear-facing digital controls make adjusting to your situation fast and easy. For reliable performance and loads of user-friendly features, look no further.

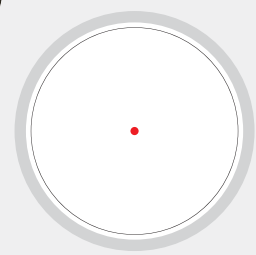

2 MOA RED DOT



The daylight bright red dot is easy to see and paints targets regardless of lighting conditions or background.

IMPROVED LONG BATTERY LIFE

DOT COLOR	ILLUMINATION SETTING 6
Bright Red	50,000 Hours

SPECS

SKU	MAGNIFICATION	DOT COLOR	WEIGHT	LENGTH	EYE RELIEF	DOT SIZE	BATTERY
SPC-AR2	1x	Bright Red	7.5 oz.	2.9"	Unlimited	2 MOA	AAA

FEATURES

- ▶ FULLY MULTI-COATED LENSES
- ▶ NITROGEN GAS PURGED
- ▶ WATERPROOF
- ▶ FOGPROOF
- ▶ SHOCKPROOF

For a description of each feature, see page 6.



STRIKEFIRE® II

RED DOT



NOW WITH

LONGER BATTERY LIFE & NIGHT-VISION COMPATIBILITY

12-HOUR AUTO SHUTOFF

CANTILEVER MOUNT INCLUDED

STRIKE WHILE THE BARREL'S HOT.

Can going bigger actually make you faster? It can when you're talking about field of view. The Strikefire® II's larger objective and 30mm tube provide a larger field of view and allow it to be mounted at just about any height using most common 30mm rings. The 4 MOA dot is easy to acquire quickly and is available in red-only or user-selected red/green models. From AR-15s to shotguns, the Strikefire® II offers super-fast, big-time versatility at a price that leaves you plenty of cash for ammo.

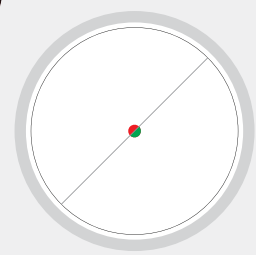

4 MOA RED/GREEN DOT



The daylight bright red dot is easy to see and paints targets regardless of lighting conditions or background.

IMPROVED LONG BATTERY LIFE

DOT COLOR	ILLUMINATION SETTING 6
Bright Red	80,000 Hours
Red/Green	300 Hours (RED) / 900 Hours (GREEN)

SPECS

SKU	MAGNIFICATION	DOT COLOR	WEIGHT	LENGTH	EYE RELIEF	DOT SIZE	BATTERY
SF-BR-504	1x	Bright Red	7.2 oz.	5.6"	Unlimited	4 MOA	CR2
SF-RG-501		Red/Green					

FEATURES

- ▶ FULLY MULTI-COATED LENSES
- ▶ NITROGEN GAS PURGED
- ▶ WATERPROOF
- ▶ FOGPROOF
- ▶ SHOCKPROOF

For a description of each feature, see page 6.



CROSSFIRE®

RED DOT



11 ILLUMINATION SETTINGS



NOW WITH

LONGER BATTERY LIFE & NIGHT-VISION COMPATIBILITY

MULTI-HEIGHT SKELETONIZED MOUNT INCLUDED

MAKE IT RAIN BRASS, RAIN OR SHINE.

The Crossfire® is a no-nonsense sight at a no-nonsense price for darn near any application. When your AR-15, shotgun, or rimfire needs a simple point of aim and none of the frills, the Crossfire® should be at the top of your list. The 2 MOA dot is quick to acquire in close-quarters, while remaining fine enough for dead-on accuracy at extended ranges. You also get 50,000 hours of battery life, plus night-vision compatibility on the two lowest illumination settings. In addition to just plain looking awesome, the included skeletonized lower 1/3 co-witness mount provides a rock-solid, extremely lightweight platform.

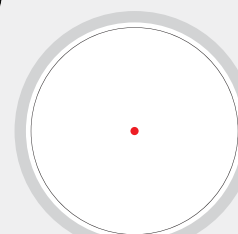

2 MOA RED DOT



The daylight bright red dot is easy to see and paints targets regardless of lighting conditions or background.

IMPROVED LONG BATTERY LIFE

DOT COLOR	ILLUMINATION SETTING 6
Bright Red	50,000 Hours

SPECS

SKU	MAGNIFICATION	DOT COLOR	WEIGHT	LENGTH	EYE RELIEF	DOT SIZE	BATTERY
CF-RD2	1x	Bright Red	5.2 oz.	2.5"	Unlimited	2 MOA	CR2032

FEATURES

- ▶ FULLY MULTI-COATED LENSES
- ▶ NITROGEN GAS PURGED
- ▶ WATERPROOF
- ▶ FOGPROOF
- ▶ SHOCKPROOF

For a description of each feature, see page 6.

RAZOR®

MICRO RED DOT



ULTRA-WIDE FIELD OF VIEW

TOP ILLUMINATION CONTROL

SIDE-LOAD BATTERY COMPARTMENT

EDGE OUT THE COMPETITION.

An open-top reflex sight built for top-tier performance and incredible versatility, the Razor® belongs on your go-to guns. Whether it's a competition rifle or your everyday carry, the large, clear, and crisp window provides edge-to-edge sharpness with a wide field of view protected by a thick, durable, aluminum housing. Choose a 3 MOA dot for finer rifle work or go 6 MOA for rapid acquisition on a handgun or shotgun. A side-load battery tray makes for quick battery changes without removing the sight. Rugged and durable, the Razor® comes in at 1.3 ounces (2.4 ounces with its included, low Picatinny mount).



The daylight bright red dot is easy to see and paints targets regardless of lighting conditions or background.

SPECS

SKU	MAGNIFICATION	DOT COLOR	WEIGHT	LENGTH	EYE RELIEF	DOT SIZE	BATTERY
RZR-2001	1x	Bright Red	1.3 oz.	1.83"	Unlimited	3 MOA	CR2032
RZR-2003						6 MOA	

FEATURES

- ▶ HD OPTICAL SYSTEM
- ▶ XR™ LENS COATINGS
- ▶ ARMORTEK®
- ▶ WATERPROOF
- ▶ SHOCKPROOF

For a description of each feature, see page 6.

VIPER®

MICRO RED DOT



ULTRA-LOW MOUNTING HEIGHT

TARGET ACQUIRED.

Red dots for sidearms better be low-profile and tough. Viper® fits the bill, and its low mounting height is perfect for handguns with cutout slides. The simplicity and speed of a red dot while co-witnessing with suppressor-height iron sights means you're always ready.

SPECS

SKU	MAGNIFICATION	DOT COLOR	WEIGHT	LENGTH	EYE RELIEF	DOT SIZE	BATTERY
VRD-6	1x	Bright Red	1.0 oz.	1.8"	Unlimited	6 MOA	CR2032

FEATURES

- ▶ FULLY MULTI-COATED LENSES
- ▶ ARMORTEK®
- ▶ WATERPROOF
- ▶ SHOCKPROOF

VENOM®

MICRO RED DOT



VIPER



VENOM



PREMIUM WIDE FIELD OF VIEW

TOP-LOAD BATTERY COMPARTMENT

BUILT FOR YOUR MOMENTS OF TRUTH.

Get fast target acquisition and a sleek form factor that won't snag. The Venom's® low-profile housing surrounds a large viewing window with next-to-no obstruction for rapid shooting transitions.

SPECS

SKU	MAGNIFICATION	DOT COLOR	WEIGHT	LENGTH	EYE RELIEF	DOT SIZE	BATTERY
VMD-3106	1x	Bright Red	1.1 oz.	1.9"	Unlimited	6 MOA	CR1632
VMD-3103						3 MOA	

FEATURES

- ▶ FULLY MULTI-COATED LENSES
- ▶ ARMORTEK®
- ▶ WATERPROOF
- ▶ SHOCKPROOF

For a description of each feature, see page 6.

SPITFIRE™ 3X

PRISM SCOPE



ILLUMINATION CONTROL



PICATINNY RAILS FOR MOUNTING ACCESSORIES

NEAR OR FAR. ON OR OFF. ALWAYS READY.

Sometimes, simpler is better and fixed-power prism scopes have been topping ARs for decades thanks to their simple, compact, reliable design. But few have come close to the combination of value and performance offered by the Spitfire™ 3x. A custom BDC reticle, designed to subtend with most popular 5.56 cartridges, takes all the guesswork out of shots from zero to 500 yards. Meanwhile, the glass-etched reticle can be used with either red or green illumination — or without any power at all, like a traditional riflescope — making for an inherently reliable, “always ready” platform.

EBR-556B MOA RETICLE

This BDC reticle is designed around the 5.56x45 cartridge. This reticle aids in rapid shooting at both near and far distances and provides holdover and ranging references from zero to 500 yards.

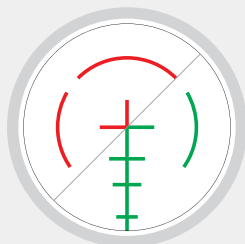

Note – Prism scopes are not compatible with magnifiers.

SPECS

SKU	MAGNIFICATION	RETICLE OPTIONS	WEIGHT	LENGTH	EYE RELIEF	FIELD OF VIEW @ 100 YARDS	BATTERY
SPR-1303	3x	EBR-556B MOA	15.4 oz.	5.5"	2.8"	31.5'	CR2032

FEATURES

- ▶ FULLY MULTI-COATED LENSES
- ▶ NITROGEN GAS PURGED
- ▶ WATERPROOF
- ▶ FOGPROOF
- ▶ SHOCKPROOF

For a description of each feature, see page 6.

SPITFIRE™ AR

PRISM SCOPE



AAA BATTERY COMPARTMENT

REAR-FACING ILLUMINATION CONTROL

DOOR KICKING, DOWN RANGE BANG MACHINE.

When all else fails, the Spitfire™ AR won't. The glass-etched DRT (Dual Ring Tactical) reticle can be used with or without the red/green illumination like a traditional riflescope, and makes target and reticle acquisition in close-quarters a snap. Unique to the Spitfire™ AR, an included 5.56 BDC turret allows shooters to dial popular AR-15 configurations to 700 yards — perfect for limited division 3-Gun competitors or shooters who want to engage targets at all ranges. Plus, it's the perfect solution if you need a 1x optic designed for close-quarters but common astigmatism renders other red dots unusable.

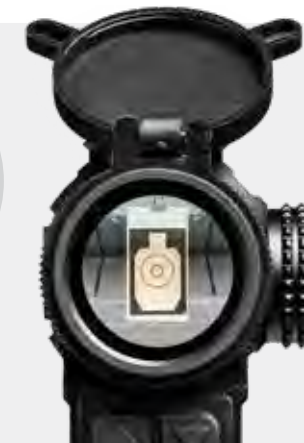
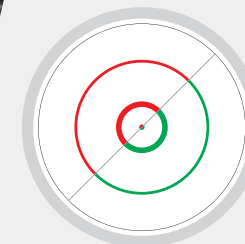

DRT MOA RETICLE

The DRT (Dual Ring Tactical) reticle is designed for rapid shooting at close distances. The dual ring design pulls the eye into instant alignment with the reticle center and target.

Note – Prism scopes are not compatible with magnifiers.

SPECS

SKU	MAGNIFICATION	RETICLE OPTIONS	WEIGHT	LENGTH	EYE RELIEF	FIELD OF VIEW @ 100 YARDS	BATTERY
SPR-200	1x	DRT MOA	11.2 oz.	4.3"	3.8"	79'	AAA*

*Lithium battery recommended.

FEATURES

- ▶ FULLY MULTI-COATED LENSES
- ▶ NITROGEN GAS PURGED
- ▶ WATERPROOF
- ▶ FOGPROOF
- ▶ SHOCKPROOF

For a description of each feature, see page 6. For detailed reticle information, see pages 128-131 or visit our website.



RED DOT ACCESSORIES



MICRO3X

MAGNIFIER

MAG ON. MAG OFF.

Next level 3X magnification versatility when you need it for your red dot or holographic sight in an ultra-compact, lightweight, and optically crisp package. Integrated quick-release allows fast attach/detach while a patented cam-lock design engages/disengages magnifier with direct pressure. Adjustable flip mount allows for right or left-handed use.

The Micro3X Magnifier will work with any of our red dots. Any existing parallax in the optic will also be magnified.

The Micro3X will not work with prism scopes.



VMX-3T

MAGNIFIER

MAKE LIGHT WORK OF LONG-RANGE.

Extend your reach with the simple, push-button design of the VMX-3T. One button engages and disengages the flip-mount, allowing the magnifier to lock in place. The result? 3x magnified or unmagnified views at will. Optics are fully multi-coated for optimal light transmission. Lightweight and tough, the anodized, machined-aluminum construction ensures durability. Internally nitrogen purged for reliable waterproof and fogproof performance. Ultimate magnified versatility for virtually any AR-height red dot.



SPORT CANTILEVER RED DOT RING



TACTICAL 30MM RING



MOUNT RISER-QR



45 DEGREE MOUNT



AR15 RISER MOUNT
(FOR RAZOR® RED DOT)



RAZOR® OFFSET MOUNT



CR2032 BATTERY HOLDER



RANGEFINDERS





RAZOR™ HD 4000

RANGEFINDER



PREMIUM HD OPTICAL SYSTEM

RANGE IN YARDS OR METERS

MAGNESIUM ALLOY CHASSIS



ULTRA BRIGHT DISPLAY



HARD CASE INCLUDED

GO THE DISTANCE. THEN RANGE IT.

When “as far as the eye can see” isn't good enough, you need the Razor™ HD 4000. The definition of what a high-end, long-range laser rangefinder should be, the Razor™ HD 4000 delivers cutting-edge optical and ranging performance, giving hunters and shooters the data needed to execute even the most demanding shots. This extremely effective, angle-compensated rangefinder features four targeting modes and two ranging modes to cover any environment. Impressive 4,000 yard reflective ranging capability (ELR mode) reaches way out for extreme precision. A utility clip keeps these compact units close at hand, and each model is easily mounted to any 1/4-20 tripod plate when you need a rock-steady base.



RANGING MODES

HORIZONTAL COMPONENT DISTANCE (HCD)
Angle compensated distance to target.

LINE OF SIGHT (LOS)
Actual line of sight range.

SCAN
Displays continuous distance readings when panning.

TARGET MODES

EXTENDED LASER RANGE (ELR)
Displays precise result.

FIRST MODE
Locks on closest result.

LAST MODE
Locks on furthest result.

NORMAL MODE
Displays the strongest result.

SPECS

SKU	MAGNIFICATION	EYE RELIEF	FIELD OF VIEW 1000 YARDS / DEGREES	MAX. RANGE	TREE RANGE	DEER RANGE	MIN. RANGE	WEIGHT	LENGTH X HEIGHT
LRF-250	7x	16mm - 19mm	341.25' / 6.5°	4000 yd.	2500 yd.	2200 yd.	5 yd.	9.9 oz.	4.5" x 3.1"

FEATURES

- ▶ HD OPTICAL SYSTEM
- ▶ XR™ PLUS LENS COATINGS
- ▶ DIELECTRIC PRISM COATINGS
- ▶ ARMORTEK®
- ▶ RUBBER ARMOR
- ▶ WATERPROOF
- ▶ SHOCKPROOF
- ▶ UTILITY CLIP
- ▶ TRIPOD ADAPTABLE

For a description of each feature, see page 6.



RANGER®

RANGEFINDER



RANGE IN YARDS OR METERS

BRIGHT RED LED DISPLAY

UTILITY CLIP (NOT SHOWN)

HOME ON THE RANGE.

Besides being easy to use, the Ranger® bucks the trend of overly complicated electronics that end up being useless in the field. The built-in angle compensation is popular with treestand hunters looking to get exact horizontal distance to a deer, and long-range shooters who need to calculate complex ballistic solutions using precise data. An illuminated display keeps you ranging at first and last light, and a utility clip keeps these compact units close at hand. The Ranger® is easily mounted to any 1/4-20 tripod plate when you need a rock-steady base.

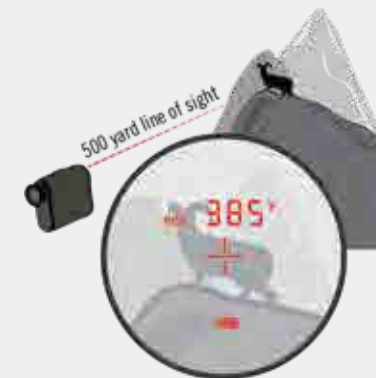

RANGING MODES

HORIZONTAL COMPONENT DISTANCE (HCD)

Angle compensated distance to target.

LINE OF SIGHT (LOS)

Actual line of sight range.

SCAN

Displays continuous distance readings when panning.

SPECS

SKU	MAGNIFICATION	EYE RELIEF	FIELD OF VIEW 1000 YARDS / DEGREES	MAX. RANGE	TREE RANGE	DEER RANGE	MIN. RANGE	WEIGHT	LENGTH X HEIGHT
RRF-181	6x	17mm	315' / 6.0°	1800 yd.	1000 yd.	900 yd.	10 yd.	7.7 oz.	3.9" x 3.0"

FEATURES

- ▶ FULLY MULTI-COATED LENSES
- ▶ RUBBER ARMOR
- ▶ WATERPROOF
- ▶ SHOCKPROOF
- ▶ UTILITY CLIP
- ▶ TRIPOD ADAPTABLE

For a description of each feature, see page 6.



IMPACT®

RANGEFINDERS

VORTEXOPTICS.COM



IMPACT®

RANGEFINDER



INTUITIVE BLACK LCD DISPLAY

RANGE IN YARDS OR METERS

MEASURE TWICE, SHOOT ONCE.

Simply put, the Impact® rangefinder's combination of excellent, reliable performance at a super-economical price means you no longer have an excuse to head out without a laser rangefinder. This lightweight, no-frills rangefinder features angle compensation for treestand hunters and casual range goers wanting precise, horizontal distance to the target. And with a max reflective distance of 850 yards, you'll have all the reach you need.



RANGING MODES

HORIZONTAL COMPONENT DISTANCE (HCD)
Angle compensated distance to target.

LINE OF SIGHT (LOS)
Actual line of sight range.

SCAN
Displays continuous distance readings when panning.

SPECS

SKU	MAGNIFICATION	EYE RELIEF	FIELD OF VIEW 1000 YARDS / DEGREES	MAX. RANGE	TREE RANGE	DEER RANGE	MIN. RANGE	WEIGHT	LENGTH X HEIGHT
LRF100	6x	15mm	341' / 6.5°	850 yd.	550 yd.	400 yd.	5 yd.	5.5 oz.	3.0" x 3.8"

FEATURES

- ▶ FULLY MULTI-COATED LENSES
- ▶ WATERPROOF
- ▶ SHOCKPROOF

For a description of each feature, see page 6.

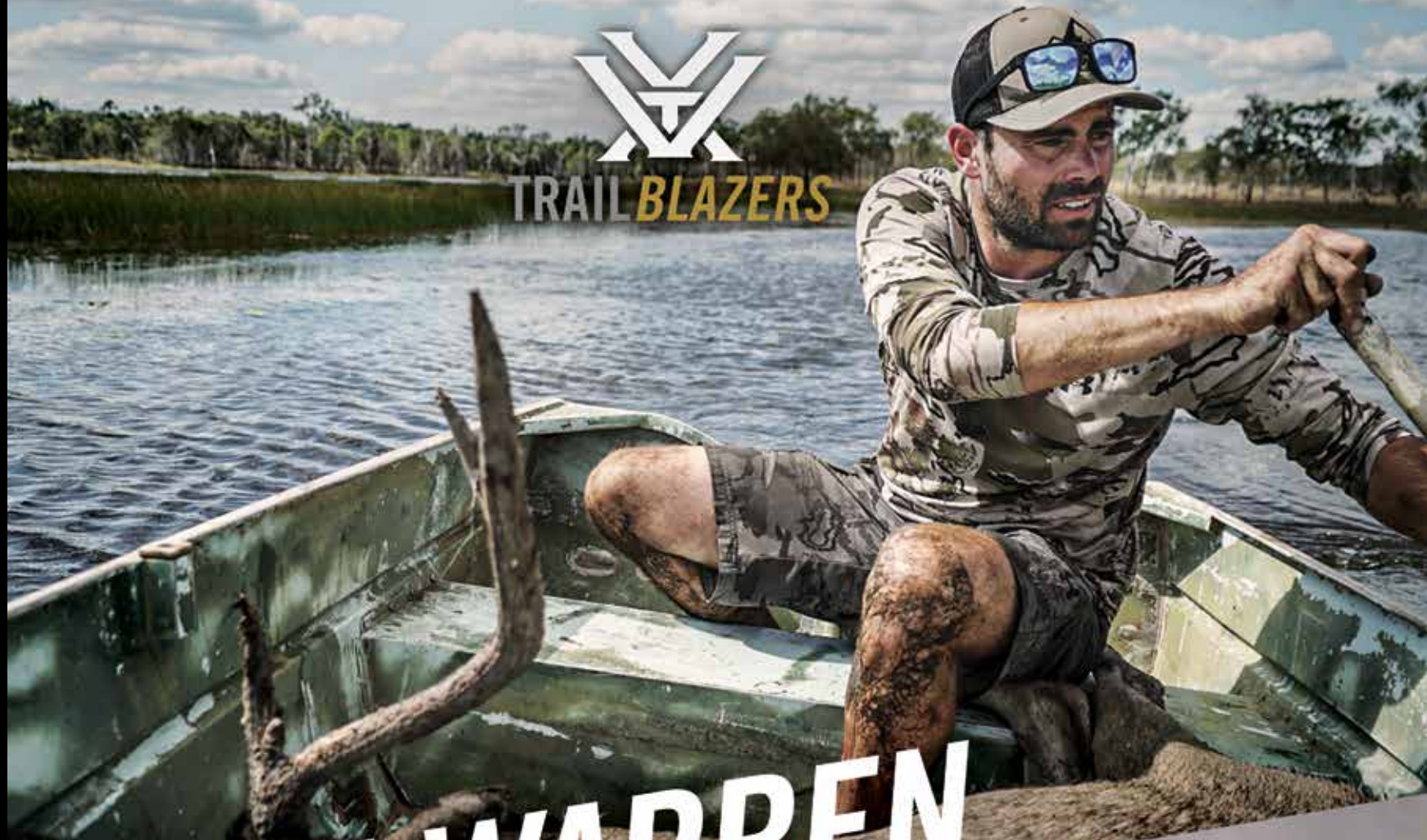

REMI WARREN



STORY TIME

OBSESSION, WEASEL WATCHING,
AND TELLING HUNTING STORIES WITH REMI WARREN

You want hunting stories? Remi Warren has a million.

Stories of perfect hunts and hunts that didn't go anywhere near according to plan. Stories of places of almost indescribable beauty and stories of being close enough to a charging brown bear to touch its thick fur.

The truth is, Warren's whole life is a hunting story. "There's pictures of me in a pack frame with my mom in a river when I wasn't even a year old. When I was a baby, I was taken along in a wall tent, hunting in Montana," he said. Before he could even shoot, he sat with his dad in the woods. "I remember a buck coming through the trees, and my dad let me watch it through the riflescope. I just remember thinking it was the coolest thing ever and I couldn't wait to go out on my own."

It didn't take long. With the fire to hunt lit, and with his family's support, Warren began spending more and more time in the field. "When other kids were out, I was practicing shooting my bow all summer. I started guiding right after high school. I'm just obsessed to the highest level. Even when I'm wore down from guiding and feel completely beat up, I could hunt every day of the year and not get tired."

From guiding, Warren branched out into becoming a brand all his own. He started his own guide service at the age of 22, Montana OutWest Outfitters. He writes extensively. He's a seasoned videographer and appears on the other side of the camera in multiple hunting shows, including Ridge Reaper, MeatEater, Apex Predator, and Solo Hunter. In the hunting world, he's everywhere, telling stories of good hunts and bad. "Getting to spend as much time as I do in the field, I feel almost a responsibility to share my stories: Some people only get to go out maybe a couple times a year, and with today's technology, I can share what I know and maybe help that person be successful in the time they have."

It's complicated though, in the internet age, to tell a good hunting story. "In the past, you couldn't give hunting content to people who didn't want it. Today, you can just be scrolling for kitten pictures and a mountain lion hunting video will pop up that you might not want to see." With his own stories, Warren is always trying to show the truth of hunting, while being very aware of how closely content can be scrutinized. "If used properly, all these online videos could be one of the most beneficial tools we have for promoting hunting. But if used poorly, it could also be something that ruins hunting for future generations."

So how do you tell a good hunting story? Ironically, the very thing that makes Warren such a good storyteller might also be what makes him a great hunter: Utilizing his senses and being able to put himself, and those who listen, smack in the middle of his story. It's classic storytelling advice: Give someone an experience they can feel.

"The sense of smell, for example, is one of the most advanced senses we have, but it's something we just ignore. When I'm hunting or guiding, there's a lot of times when I smell elk before I ever see them. Being in a city, you dumb down a lot of your senses because you don't want to smell all those smells, you don't want to hear all those sounds. Our brains are so advanced; we can compute so many sensory impressions. If you can tap into that when you're out hunting, it's incredible how much you can pick up outside of just seeing."

For Warren, who spends between 200 and 300 days out of the year in the field, being tapped into everything his senses are trying to tell him is a part of the job he loves. He said, "When I'm hunting, I feel alive; I feel like this is where I'm supposed to be. There's the hardships that go along with it, but it just feels like the way I'm supposed to live."

Part of that is being in touch with his surroundings, but he also appreciates how hunting shows him what's necessary. He said, "One of the things I really love about backpack hunting is you carry everything you need with you, and you don't really need a lot. And I like that feeling, of being self-reliant. Then, you get back home, and you have all this stuff around, all these comforts. And it's like, 'I don't need any of this.'"

Warren believes that learning to strip away those comforts and distractions, to trust and understand your senses and instincts, is what makes you better as a hunter. "I remember watching out in my backyard, a mother weasel teaching baby weasels how to kill rabbits. She'd have them go into this rabbit den, one at a time, and each one came out with a rabbit. Weasels are taught how to hunt, but there's also something in that weasel that is innate, that will figure out how. You need to tap into those hunter instincts, to trust them. It takes a lifetime being out there, learning what instincts actually are."

Those lessons don't always come easy; Warren has been in plenty of situations where his life was in danger. One story though, stands out as very nearly being his last. "I was guiding this lady in New Zealand and she shot this Chamois up on a cliff. I figured it would fall, but it got stuck about halfway down on the other side. I just decided I'd climb over there and get it down, it shouldn't be too bad." The client was older, and Warren wanted to make sure she got the Chamois, a small member of the goat-antelope family.

"So I'm climbing, and it's pretty vertical, and it's soft ground, but also a lot of rock. Where it ended up, I had to climb up above it, and there was this rock that had pulled out from the face and that's where it had stuck. I grab the Chamois and I pitch it off the cliff and I kind of just expected it to hit the ground. And it was falling ... and falling ... and falling. And I just started shaking. It really put it into perspective: If you slip, you're dead. And I wasn't going to be able to climb down from there. My hands were freezing because the ground was still wet and kind of frozen." It's the most scared Warren has ever felt in the field. "One small slip and I'd be dead; that Chamois was falling for so long, I had a lot of complete thoughts before it hit."

He found a way to climb up, and eventually a route out. "When I got back, I grabbed the Chamois and carried it up to the lady and she was crying, just balling, and she started hitting me, and cussing at me, and she said, 'Never do that again! Nothing is worth that!' And I thought, 'Point taken.' You just can't do that kind of stuff. It's just not worth it."

To Warren, the rewards of a life spent learning in the field are more than worth the risks. "Hunters know places in a way that other people don't. When someone who doesn't hunt looks at a mountain I hunt regularly, they just see a mountain. But I see the draws, the little pockets, certain trees on certain sides. I see the mountain completely different, and that's a really cool feeling."



BINOCULARS





RAZOR® UHD

BINOCULARS

VORTEXOPTICS.COM



RAZOR® UHD

FULL-SIZE ABBE-KOENIG PRISM BINOCULARS



**BINO PACK
INCLUDED**

A NEW ERA OF OBSERVATION.

When it comes to serious glassing, the details are what matters most, and with the Razor® UHD you won't miss a thing. Built lens-to-lens for those who demand the best in each component, the Razor® UHD provides exceptional optical quality and color fidelity. An optical system built around an Abbe-Koenig prism means better light transmission, while advanced lens coatings conquer low-light situations. The larger prism provides better image resolution whether looking near or far. See more with the Razor® UHD.

SPECS

SKU	MODEL	INTERPUPILLARY DISTANCE	EYE RELIEF	CLOSE FOCUS	FIELD OF VIEW 1000 YARDS / DEGREES	WEIGHT	HEIGHT X WIDTH
RZB-3104	18x56	56mm - 76mm	18.0mm	10.0'	194' / 3.7°	41.6 oz.	8.3" x 6.1"
RZB-3103	12x50	56mm - 76mm	17.0mm	6.6'	288' / 5.5°	36.1 oz.	7.6" x 5.8"
RZB-3102	10x42	56mm - 76mm	16.7mm	4.5'	346' / 6.6°	32.2 oz.	7.0" x 5.6"
RZB-3101	8x42	56mm - 76mm	16.7mm	4.5'	420' / 8.0°	32.2 oz.	7.0" x 5.6"

FEATURES

- ▶ UHD OPTICAL SYSTEM
- ▶ XR™ PLUS LENS COATINGS
- ▶ PLASMA TECH
- ▶ PHASE CORRECTION
- ▶ APOCHROMATIC
- ▶ ARMORTEK®
- ▶ RUBBER ARMOR
- ▶ ARGON GAS PURGED
- ▶ WATERPROOF
- ▶ FOGPROOF
- ▶ SHOCKPROOF

For a description of each feature, see page 6.



RAZOR® HD

BINOCULARS

VORTEXOPTICS.COM



RAZOR® HD

FULL-SIZE ROOF PRISM BINOCULARS



GLASSPAK™
INCLUDED

YOUR HIDE-AND-SEEK CHEAT CODE.

Small, light, bright, and strong, with all the magnification ranges you need to work wild places coast to coast. Incredibly clear HD glass, and a rock-solid build that won't weigh you down, make this the perfect bino to trust on a day hike, and the hunt of a lifetime.

SPECS

SKU	MODEL	INTERPUPILLARY DISTANCE	EYE RELIEF	CLOSE FOCUS	FIELD OF VIEW 1000 YARDS / DEGREES	WEIGHT	HEIGHT X WIDTH
RZB-2104	12x50	57mm - 74mm	15.5mm	10.0'	285' / 5.4°	28.7 oz.	6.8" x 5.1"
RZB-2103	10x50	57mm - 74mm	16.5mm	10.0'	315' / 6.0°	28.1 oz.	6.8" x 5.1"
RZB-2102	10x42	55mm - 75mm	16.5mm	6.0'	362' / 6.9°	24.8 oz.	5.9" x 5.1"
RZB-2101	8x42	55mm - 75mm	17.5mm	6.0'	388' / 7.4°	24.2 oz.	5.9" x 5.1"

FEATURES

- ▶ HD OPTICAL SYSTEM
- ▶ XR™ PLUS LENS COATINGS
- ▶ DIELECTRIC PRISM COATINGS
- ▶ PLASMA TECH
- ▶ PHASE CORRECTION
- ▶ APOCHROMATIC
- ▶ ARMORTEK®
- ▶ RUBBER ARMOR
- ▶ ARGON GAS PURGED
- ▶ WATERPROOF
- ▶ FOGPROOF
- ▶ SHOCKPROOF

For a description of each feature, see page 6.

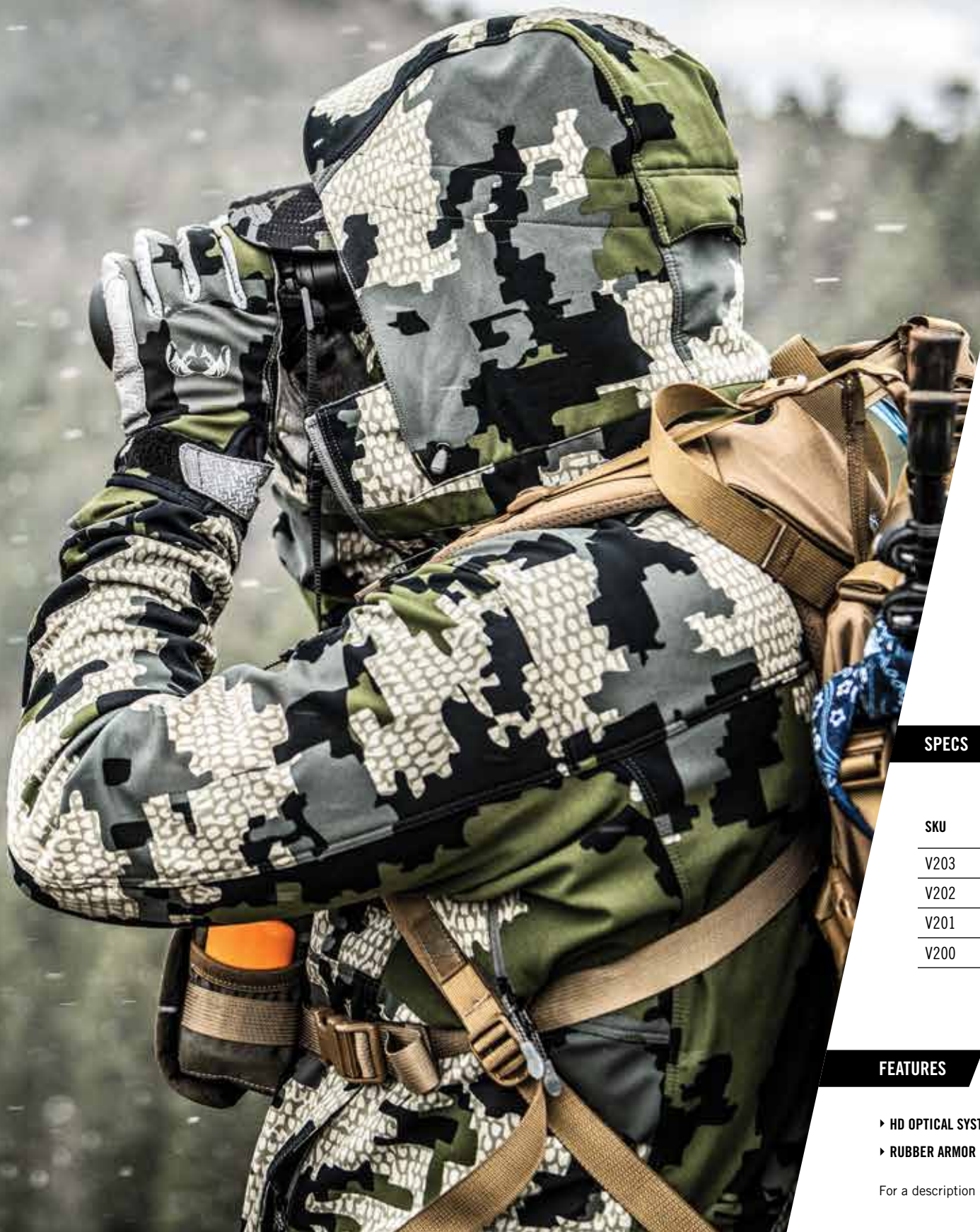

VIPER® HD

FULL-SIZE ROOF PRISM BINOCULARS



GLASSPAK™
INCLUDED

BUILT TO CARRY WHERE OTHERS FEAR TO TREAD.

Viper® HD binoculars are an optical masterpiece, giving hunters, shooters, and outdoor enthusiasts a premium option without the premium price tag. The HD optical system delivers stunning resolution, brilliant color fidelity, and edge-to-edge clarity. These are one of the lightest, most compact, full-size bins on the market — no small thing on hunts and excursions where every ounce matters. The perfect combo of price and function, reach for the Viper® HD when you need to pack light without sacrificing performance.

SPECS

SKU	MODEL	INTERPUPILLARY DISTANCE	EYE RELIEF	CLOSE FOCUS	FIELD OF VIEW 1000 YARDS / DEGREES	WEIGHT	HEIGHT X WIDTH
V203	12x50	56mm - 75mm	16mm	9.5'	288' / 5.5°	28.8 oz.	6.5" x 5.2"
V202	10x50	56mm - 75mm	16mm	9.5'	346' / 6.6°	28.4 oz.	6.5" x 5.2"
V201	10x42	56mm - 75mm	17mm	6.5'	341' / 6.5°	24.9 oz.	5.6" x 4.9"
V200	8x42	56mm - 75mm	18mm	6.5'	409' / 7.8°	24.5 oz.	5.6" x 4.9"

FEATURES

- ▶ HD OPTICAL SYSTEM
- ▶ XR™ LENS COATINGS
- ▶ DIELECTRIC PRISM COATINGS
- ▶ PHASE CORRECTION
- ▶ ARMORTEK®
- ▶ RUBBER ARMOR
- ▶ ARGON GAS PURGED
- ▶ WATERPROOF
- ▶ FOGPROOF
- ▶ SHOCKPROOF

For a description of each feature, see page 6.



DIAMONDBACK® HD

FULL / MID / COMPACT-SIZE ROOF PRISM BINOCULARS



GLASSPAK™
INCLUDED
(SELECT MODELS ONLY)

EXPERIENCE LOVE AT FIRST LIGHT.

Take a binocular that broke all the rules about performance at its price point. Add an HD optical system to give it even more clarity. The result? The Diamondback® HD, an astoundingly efficient and high-performing bino with enhanced, dielectric, fully multi-coated lenses serving up impressive low-light performance — critical when glassing and evaluating game. Plus, we're now including the GlassPak™ binocular harness so your bins are always at the ready.

SPECS

SKU	MODEL	INTERPUPILLARY DISTANCE	EYE RELIEF	CLOSE FOCUS	FIELD OF VIEW 1000 YARDS / DEGREES	WEIGHT	HEIGHT X WIDTH
DB-217	12x50	60mm - 75mm	14mm	6.0'	271' / 5.2°	28.9 oz.	6.4" x 5.3"
DB-216	10x50	60mm - 75mm	17mm	6.0'	315' / 6.0°	30.0 oz.	6.6" x 5.3"
DB-215	10x42	55mm - 73mm	15mm	5.0'	330' / 6.3°	21.3 oz.	5.7" x 5.1"
DB-214	8x42	55mm - 73mm	17mm	5.0'	393' / 7.5°	21.8 oz.	5.7" x 5.1"
DB-213	10x32	57mm - 73mm	14mm	6.0'	340' / 6.5°	16.0 oz.	4.4" x 5.0"
DB-212	8x32	57mm - 73mm	16mm	5.0'	426' / 8.1°	15.9 oz.	4.4" x 4.6"
DB-211	10x28	55mm - 72mm	16mm	6.0'	273' / 5.1°	13.5 oz.	4.6" x 4.5"
DB-210	8x28	55mm - 72mm	18mm	6.0'	332' / 6.2°	14.0 oz.	4.6" x 4.5"

FEATURES

- ▶ HD OPTICAL SYSTEM
- ▶ FULLY MULTI-COATED LENSES
- ▶ DIELECTRIC PRISM COATINGS
- ▶ PHASE CORRECTION
- ▶ RUBBER ARMOR
- ▶ ARGON GAS PURGED
- ▶ WATERPROOF
- ▶ FOGPROOF
- ▶ SHOCKPROOF

For a description of each feature, see page 6.



CROSSFIRE® HD

BINOCULARS

VORTEXOPTICS.COM



CROSSFIRE® HD

FULL-SIZE ROOF PRISM BINOCULARS



GLASSPAK™
INCLUDED

MORE COLOR. MORE FIDELITY. MORE FILLED TAGS.

The best value in optics is now even better with the introduction of the Crossfire® HD. Not only do you get all new, optimized glass elements and coatings, we're also including the GlassPak™ binocular harness to make the Crossfire® HD as much a pleasure to carry as it is to use. More fidelity, and more extras, than ever before make Crossfire® HD a must have.

SPECS

SKU	MODEL	INTERPUPILLARY DISTANCE	EYE RELIEF	CLOSE FOCUS	FIELD OF VIEW 1000 YARDS / DEGREES	WEIGHT	HEIGHT X WIDTH
CF-4314	12x50	60mm - 76mm	15mm	6.0'	273' / 5.2°	29.5 oz.	6.6" x 5.3"
CF-4313	10x50	60mm - 76mm	17mm	6.0'	320' / 6.1°	30.4 oz.	6.7" x 5.3"
CF-4312	10x42	58mm - 75mm	15mm	6.0'	325' / 6.2°	23.0 oz.	6.0" x 5.2"
CF-4311	8x42	58mm - 75mm	17mm	6.0'	393' / 7.5°	23.8 oz.	6.25" x 5.2"

FEATURES

- ▶ HD OPTICAL SYSTEM
- ▶ FULLY MULTI-COATED LENSES
- ▶ PHASE CORRECTION
- ▶ RUBBER ARMOR
- ▶ NITROGEN GAS PURGED
- ▶ WATERPROOF
- ▶ FOGPROOF
- ▶ SHOCKPROOF

For a description of each feature, see page 6.

KAIBAB® HD

FULL-SIZE ROOF PRISM BINOCULARS



THE POWER TO MOVE MOUNTAINS.

The key ingredients for a successful big-game stalk? Patience, perseverance, and the kind of optical reach you'll find in the Kaibab® HD. The superior viewing experience of binoculars, but with the power you need for long-distance glassing, the Kaibab® HD delivers the premium, high-magnification optical performance it takes to give your dream hunt a happy ending. Heads up: These high performing, high power binoculars are intended to be used with a tripod for extended, comfortable, steady viewing.

Note – Recommended for use with a tripod. Tripod adapter included.

SPECS

SKU	MODEL	INTERPUPILLARY DISTANCE	EYE RELIEF	CLOSE FOCUS	FIELD OF VIEW 1000 YARDS / DEGREES	WEIGHT	HEIGHT X WIDTH
KAI-5618	18x56	60mm - 76mm	16.4mm	19.8'	194' / 3.7°	43.5 oz.	7.7" x 5.7"

FEATURES

- ▶ HD OPTICAL SYSTEM
- ▶ XR™ PLUS LENS COATINGS
- ▶ DIELECTRIC PRISM COATINGS
- ▶ PLASMA TECH
- ▶ PHASE CORRECTION
- ▶ APOCHROMATIC
- ▶ ARMORTEK®
- ▶ RUBBER ARMOR
- ▶ ARGON GAS PURGED
- ▶ WATERPROOF
- ▶ FOGPROOF
- ▶ SHOCKPROOF

For a description of each feature, see page 6.

VULTURE® HD

FULL-SIZE ROOF PRISM BINOCULARS



MADE FOR THOSE WHO BELIEVE YOU CAN'T GO TOO FAR.

The Vulture® HD is perfect for wide-open western landscapes where intense scrutiny of game-hiding terrain is a primary tactic. Phase-corrected roof prisms and fully multi-coated lenses with proprietary XR™ anti-reflective coatings deliver super-bright images, edge-to-edge. Long-range tripod glassing is an art, and the Vulture® HD gives you the tools you need to create a masterpiece.

Note – Recommended for use with a tripod. Tripod adapter included.

SPECS

SKU	MODEL	INTERPUPILLARY DISTANCE	EYE RELIEF	CLOSE FOCUS	FIELD OF VIEW 1000 YARDS / DEGREES	WEIGHT	HEIGHT X WIDTH
VR-1556	15x56	59mm - 74mm	15mm	15.0'	226' / 4.3°	43.6 oz.	7.6" x 5.8"

FEATURES

- ▶ HD OPTICAL SYSTEM
- ▶ XR™ LENS COATINGS
- ▶ DIELECTRIC PRISM COATINGS
- ▶ PHASE CORRECTION
- ▶ ARMORTEK®
- ▶ RUBBER ARMOR
- ▶ ARGON GAS PURGED
- ▶ WATERPROOF
- ▶ FOGPROOF
- ▶ SHOCKPROOF

For a description of each feature, see page 6.





FURY® HD 5000

LASER RANGEFINDING BINOCULARS



BRIGHT RED
OLED DISPLAY

RANGE IN YARDS
OR METERS



GLASSPAK™
INCLUDED

SIMPLIFY. MAGNIFY.

One trip into the backcountry with a heavy pack and you realize the less you have to carry, the better. The Fury® HD 5000 rangefinding binoculars combine two of the most important pieces of hunting gear into one powerful, long-ranging unit, making glassing and ranging ultra-fast and efficient. Right-side button controls make one-handed manipulation of both functions quick and easy, cutting down on set up time in the field.



RANGING MODES

HORIZONTAL COMPONENT DISTANCE (HCD)
Angle compensated distance to target.

LINE OF SIGHT (LOS)
Actual line of sight range.

SCAN
Displays continuous distance readings when panning.

TARGET MODES

BEST MODE
Displays strongest result.

LAST MODE
Displays furthest result.

SPECS

SKU	MODEL	INTERPUPILLARY DISTANCE	EYE RELIEF	CLOSE FOCUS	FIELD OF VIEW 1000 YARDS / DEGREES	MAX. RANGE	TREE RANGE	DEER RANGE	MIN. RANGE	WEIGHT	HEIGHT X WIDTH
LRF301	10x42	58mm - 72mm	16mm	18.5'	321.6' / 6.1°	5000 yd.	2400 yd.	1600 yd.	5 yd.	32.3 oz.	5.75" x 5.0"

FEATURES

- ▶ HD OPTICAL SYSTEM
- ▶ XR™ PLUS LENS COATINGS
- ▶ DIELECTRIC PRISM COATINGS
- ▶ PHASE CORRECTION
- ▶ ARMORTEX®
- ▶ RUBBER ARMOR
- ▶ NITROGEN GAS PURGED
- ▶ WATERPROOF
- ▶ FOGPROOF
- ▶ SHOCKPROOF

For a description of each feature, see page 6.

RAPTOR™

MID-SIZE PORRO PRISM BINOCULARS



RECONNECT WITH YOUR WILD SIDE.

A classic look, updated with high-quality glass, makes for one fantastic, affordable optic. Porro prism performance in a mid-size, wide-angle design, Raptor™ binoculars offer bright, crisp images with excellent color fidelity, even in low-light conditions. Plus, the design accommodates a wide range of interpupillary distances to fit everyone in the family.

SPECS

SKU	MODEL	INTERPUPILLARY DISTANCE	EYE RELIEF	CLOSE FOCUS	FIELD OF VIEW 1000 YARDS / DEGREES	WEIGHT	HEIGHT X WIDTH
R310	10x32	50mm - 70mm	13mm	15.0'	339' / 6.3°	17.6 oz.	4.5" x 5.7"
R385	8.5x32	50mm - 70mm	14mm	15.0'	390' / 7.4°	17.3 oz.	4.5" x 5.7"

FEATURES

- ▶ SD OPTICAL SYSTEM
- ▶ FULLY MULTI-COATED LENSES
- ▶ RUBBER ARMOR
- ▶ NITROGEN GAS PURGED
- ▶ WATERPROOF
- ▶ FOGPROOF
- ▶ SHOCKPROOF

For a description of each feature, see page 6.

VANQUISH®

COMPACT REVERSE PORRO PRISM BINOCULARS



SMALL WONDER.

The Vanquish® is proof positive you can pack an awful lot of innovation into a small package. The reverse porro prism design uses high quality glass and fully multi-coated optics to render crisp, bright images with a wide field of view that makes quick work of scanning any landscape. Weighing in at just 12.7 ounces and affordably priced, this compact performer will earn a place in your pack.

SPECS

SKU	MODEL	INTERPUPILLARY DISTANCE	EYE RELIEF	CLOSE FOCUS	FIELD OF VIEW 1000 YARDS / DEGREES	WEIGHT	HEIGHT X WIDTH
VNQ-1026	10x26	57mm - 71mm	16mm	7.6'	294' / 5.6°	12.7 oz.	4.7" x 4.4"
VNQ-0826	8x26	57mm - 71mm	15mm	7.6'	352' / 6.7°	12.7 oz.	4.7" x 4.4"

FEATURES

- ▶ SD OPTICAL SYSTEM
- ▶ FULLY MULTI-COATED LENSES
- ▶ RUBBER ARMOR
- ▶ NITROGEN GAS PURGED
- ▶ WATERPROOF
- ▶ FOGPROOF
- ▶ SHOCKPROOF

For a description of each feature, see page 6.





BINOCULAR ACCESSORIES



GLASSPAK™ BINOCULAR HARNESS

Protecting your binos from the elements while keeping them close at hand is imperative in the field, and the Vortex® GlassPak™ binocular harness accommodates a range of full-size binoculars, keeping them snug and secure. The mesh side pockets hold calls, a lens pen, and other small items for quick access. Tethers attach to your binoculars preventing accidental drops, and the rear zippered pocket holds larger items, such as a cell phone.



GUIDE BINOPACK

Protect your binoculars, keep the lenses clean, and carry essential gear with the Guide BinoPack. An integrated bino leash prevents drops and lets you lower your binoculars with confidence. A generous, front zippered pouch with shell loops is perfect for larger items such as rangefinders, a knife, fire starters, and whatever else you need at your fingertips. The side pockets, zippered pocket on the rear face, and elastic sleeves on the top hold additional items.



BINOCULAR HARNESS

Say goodbye to neck strain and keep your binoculars still while you walk the trail. This comfortable strap keeps binos, rangefinders, and even cameras from jostling around as you move, leaving your hands free.



ARCHER'S BINOCULAR STRAP

Comfort and simplicity, that's what you need to keep your binos close for when you need them, and out of the way when it's time to take your shot. The Archer's Binocular Strap is built to last, and to keep you comfortable, so you can focus on the hunt.



UNI-DAPTOR TRIPOD ADAPTER

When you need stability and control, the Vortex® Uni-Daptor is precision machined and fits any tripod-adaptable binocular. Its slim profile fits between the barrels of the largest high-powered binoculars, and a lift-off connector means the binocular can be removed for hand-held use without disconnecting the entire adapter.



BINOCULAR TRIPOD ADAPTER

For long-term viewing, there's nothing better than getting the weight of your binoculars off your hands and shoulders and onto a tripod or car window mount. Quick and easy setup means you spend your time glassing, not fiddling with hardware.



2X DOUBLER

Sometimes, every ounce counts, but you still need to reach farther than your binos alone allow. This handy tool is super lightweight and doubles the magnification of most 32mm or larger binoculars, and the Recon® monocular, to take in more details.

GLASSPAK™ BINOCULAR HARNESS
 Now included with:
 RAZOR® HD
 VIPER® HD
 FURY® HD 5000
 DIAMONDBACK® HD
 CROSSFIRE® HD



Ryan M. - Customer Service
1-608-826-6103 EXT. 1103

TROUBLESHOOT. OR, SHOOT THE BREEZE.

When you call Vortex® for help with your optics, you talk to real experts with real experience in finding answers to your questions. They're also pretty darn good for a conversation.



UNCONDITIONAL. UNLIMITED. LIFETIME WARRANTY.

Vortex® will repair or replace the product. Absolutely free—no matter the cause.

Does not cover loss, theft, deliberate damage, or cosmetic damage that does not hinder the performance of the product.



JEREMIAH DOUGHTY

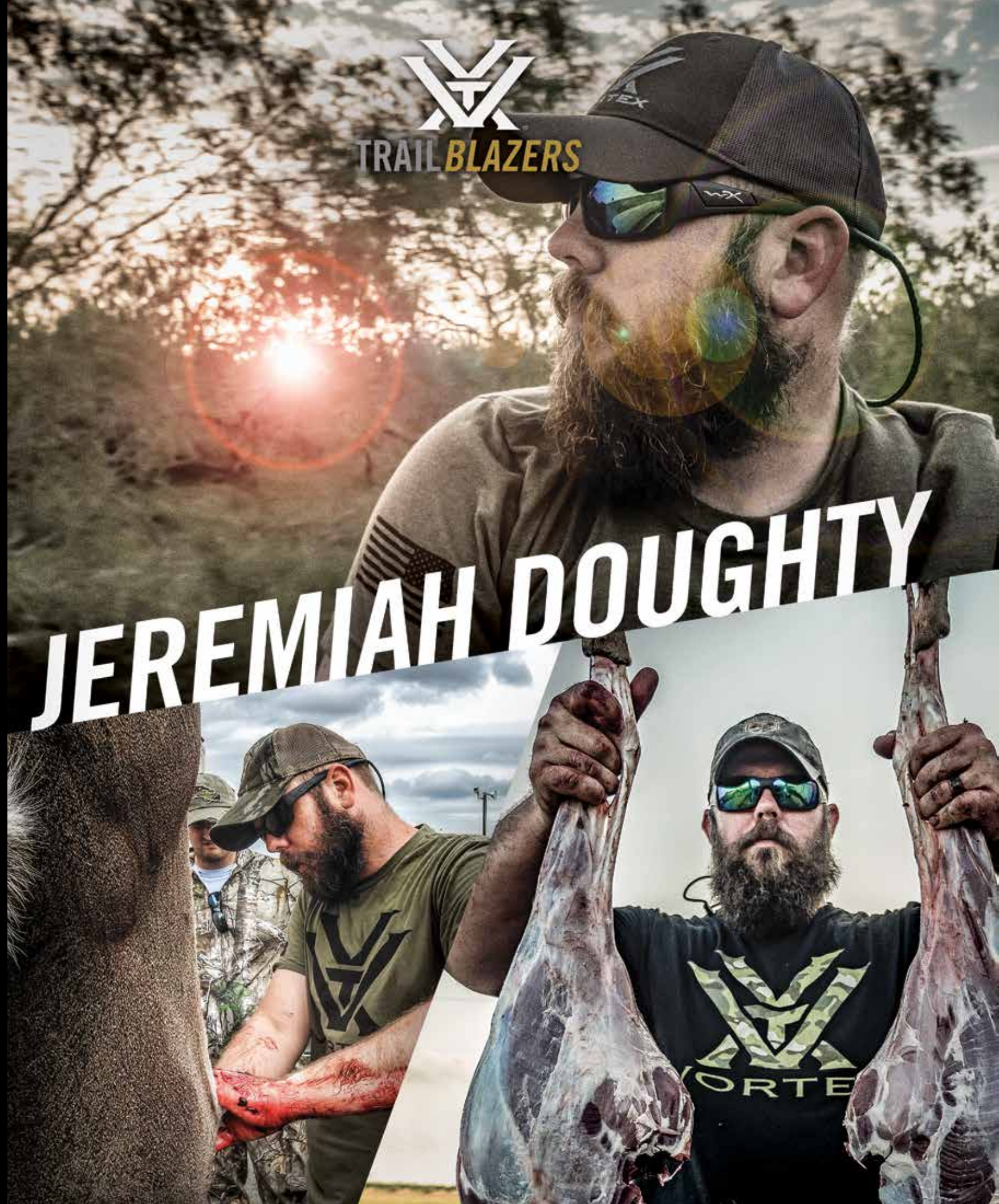

THE POWER OF ONE BITE

BUILDING RECIPES, EATING MEMORIES, AND RECRUITING
NEW HUNTERS WITH JEREMIAH DOUGHTY

Naturally, it all started with a single bite of food.

“For being raised an Irish kid, eating meat and potatoes every day, it was hard,” Jeremiah Doughty said.

What he means is that seven years ago, he took a bite of beef and an allergy that’d been building in his blood since he was a child suddenly became a defining factor in his life. “Imagine getting the worst flu of your life for about four hours after you eat. I was getting so sick, it started affecting my relationships with friends, family, and my wife because I wouldn’t want to do anything; I wouldn’t want to go out.”

At the time, doctors told him it was likely a gluten allergy. “But I could eat a peanut butter and jelly sandwich and be fine.” So, his search for answers, and the sickness, wore on. “I said, ‘It’s not gluten, it’s not dairy,’ and finally it came down to them saying, ‘Hey, you’re allergic to beef and certain fats and oils.’”

Unwilling to accept an allergy to beef, Doughty still cut it out of his diet for 30 days. “And I felt absolutely incredible. Still, I was thinking, ‘This can’t be it. There’s got to be something else.’ And so, as soon as I could go back to eating it, I went out and bought a 32 oz. Ribeye. And I was like, ‘I have missed this.’ I took four bites and I was puking my guts out. And it was like, ‘Okay, this is my life now.’”

For a time, he lived on fish and birds — game he’d grown up hunting with his family — while having to avoid pork because it’s frequently processed in the same places that process beef, and even trace amounts of Bovine protein could make him violently ill.

Then, a chance encounter changed his life again. “I was out for Fall turkey and I ran into a guy who was going to Wyoming to hunt antelope. And I said, ‘Man, I wish I could go hunt out of state but it’s so expensive.’ And the guy said it was \$38 for an out of state license and tags for antelope.”

That gave Doughty pause. His allergy only prevented him from eating beef; meat taken from the wild wouldn’t make him sick. “I remember putting my bow back in the case and going home. I bought two tags and went and bought a rifle and a \$30 scope. I had no idea what I was doing and I went to Wyoming. But at the end of seven days, I finally got an antelope. I pulled out a Swiss Army pocket knife I got when I was nine years old and tried to gut this thing watching a YouTube video in the middle of Casper, Wyoming. I got home and cooked it up. I took one bite ... and I hated the meat. I tried to cook it like a steak and that’s not how you do it.”

But that one bite neatly tied together two parts of Doughty’s life: His allergy, and a lifetime spent cooking. “Growing up in a family with seven kids, someone always had to cook dinner with mom. My siblings would always pay me to do it because they didn’t want to cook.”

Without formal training as a chef, Doughty was left to his own devices — and a career as a restaurant trainer, where he often experimented with recipes on the side to draw variety out of the same stock of food — and he began to develop a philosophy about wild game and cooking that still informs his recipes today.

“When you’re in a restaurant, you’re creating something on a scale that will excite the masses, and I don’t want to create that.” Instead, Doughty looks for something far more intimate and meaningful. “I want my daughter to say, ‘Can you make that again?’ I want to have friends over who’ve said, ‘I don’t want to eat wild game’ and I want them to say, ‘Dude, I want to go and shoot an elk,’ because of a single bite of food.”

Doughty’s recipes often start before he even harvests an animal. “When I see the animal in the field, I’m already imagining food in my head. I got asked by somebody — we were out hunting whitetail, and a deer comes in — and the guy is like, ‘Oh my gosh, what’s going through your head? That’s a monster!’ I was like, ‘I’m just thinking: I could probably get six-pound backstraps off this guy.’ He goes, ‘Yeah but look at the size of his rack!’ I said, ‘Yeah, but I’ve tried eating horn and it just doesn’t taste good.’”

What does taste good to Doughty, and the millions who have downloaded his recipes in the three years since he started From Field to Plate, is taking the time to enhance meat’s natural flavors rather than trying to bury them in seasoning. “One of the best wild turkeys I ever had was off a wild apple orchard. The turkeys were getting drunk on fermented apples that’d fallen on the ground. But as we got into plucking that turkey, you could smell these fermented red apples. For me, a recipe came to mind. I went and bought an apple bourbon whiskey and I made a cinnamon bourbon whiskey glaze and I cooked this wild turkey in fresh apples off that guy’s orchard.”

It’s exactly that focus on honoring the animal and the animal’s natural flavors that’s drawn hundreds of new hunters to Doughty and his From Field to Plate classes. And, according to Doughty, it’s not a moment too soon. “We’re down millions of hunters in the United States. And it’s because we’re not trying to reach out to a different culture and a different genre of people.”

For Doughty, that untapped pool of potential hunters includes anti-hunters. “I always come at anti-hunters from an angle of love and respect because that’s how I want to be treated. Last year, I took out three now ex-vegans on their first hunts who, six months earlier, were giving me death threats. I take them out in the field, and they start to realize the process I follow, and the respect I have for the animal, and the idea behind the meal. It’s amazing to sit there with someone who hasn’t eaten meat for twenty years, and watch them shoot an animal, and to be able to just sit in the blind and cry with them.”

Doughty then helps mentees and those in his classes break down their animals and provides tips on cooking them. He knows they’ll go home and feed their family and friends, and he knows all too well the power of a single bite of food. “To me, breakfast, lunch, and dinner, when done properly, should add to your life. Say your grandma made the best biscuits and gravy. When you go to a restaurant and you smell biscuits and gravy, all those emotions and memories from grandma’s biscuits and gravy flood your mind. And you’re like, ‘I got to get biscuits and gravy because I miss my grandma.’ And, it might not be as good as grandma’s, but you’re eating your emotions. You’re eating a memory.”

What’s next for Doughty? More of the same, he thinks, running classes and being there for people who want to know more about harvesting and cooking wild game. “I had one guy who called me from Michigan. It’s four in the morning in California. I rolled out of bed and went downstairs and sat on the couch and walked this dude through how to butcher his deer over Skype. And just to see the joy in his eyes, that someone would take the time to help. And right now, you know, this is who I want to be.”



MONOCULARS



RECCE PRO® HD

MONOCULAR



THE PERFECT SIDEKICK.

Carry precision and speed at your fingertips with the RECCE Pro®. HD glass, an MRAD milling reticle, and a compact form factor make it the perfect solution for shooters who need to spot and call shots from the bench, or in the line of duty. An integrated carry clip provides quick external access on webbing or flat-edged surfaces. Weighing in at 11 ounces, it's ready to handle any environment with fully waterproof and fogproof construction.

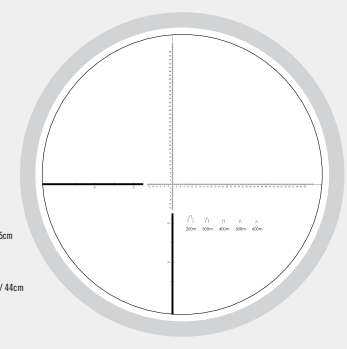

R/T RANGING RETICLE

Uses MRAD-based subtensions and includes silhouettes for quick ranging. The angular measurements allow you to calculate ranges when comparing the reticle to objects of known dimension.

SPECS

SKU	MODEL	EYE RELIEF	CLOSE FOCUS	FIELD OF VIEW 1000 YARDS / DEGREES	WEIGHT	LENGTH
RP-100	8x32	14.5mm	5.0'	400' / 7.6°	11.0 oz.	6.2"

FEATURES

- ▶ HD OPTICAL SYSTEM
- ▶ XR™ LENS COATINGS
- ▶ ARMORTEK®
- ▶ RUBBER ARMOR
- ▶ UTILITY CLIP
- ▶ ARGON GAS PURGED
- ▶ WATERPROOF
- ▶ FOGPROOF
- ▶ SHOCKPROOF

For a description of each feature, see page 6.

RECON® R/T

MONOCULAR



POCKET SIZED SPOTTING SCOPE.

The Recon® R/T is an advanced tactical monocular unlike any other in the field: It's the first truly compact, full-featured spotting scope in the Vortex® line developed specially for field surveillance and range estimation with MRAD-based subtensions and secondary quick ranging silhouettes. The versatile attachment clip secures the Recon® R/T to any belt or strap, so it's ready at a moment's notice.

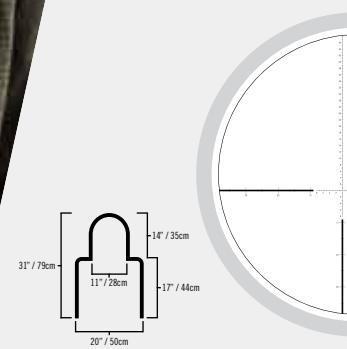

R/T RANGING RETICLE

Uses MRAD-based subtensions and includes silhouettes for quick ranging. The angular measurements allow you to calculate ranges when comparing the reticle to objects of known dimension.

SPECS

SKU	MODEL	EYE RELIEF	CLOSE FOCUS	FIELD OF VIEW 1000 YARDS / DEGREES	WEIGHT	LENGTH
RT155	15x50	16mm	12.0'	215' / 4.1°	15.2 oz.	7.0"

FEATURES

- ▶ XD™ OPTICAL SYSTEM
- ▶ XR™ LENS COATINGS
- ▶ ARMORTEK®
- ▶ RUBBER ARMOR
- ▶ UTILITY CLIP
- ▶ ARGON GAS PURGED
- ▶ WATERPROOF
- ▶ FOGPROOF
- ▶ SHOCKPROOF

For a description of each feature, see page 6.



SOLO®

MONOCULAR



GO SOLO.

The Solo® monocular delivers quality viewing for outdoor enthusiasts looking to bring nature closer with an optic that won't weigh them down. With models weighing between 5.6 ounces and 9.7 ounces, this monocular is ultra-compact, and features an integral utility clip to keep it close at hand. From bow hunters to backpackers, the Solo® makes a great addition to any gear list.

SPECS

SKU	MODEL	EYE RELIEF	CLOSE FOCUS	FIELD OF VIEW 1000 YARDS / DEGREES	WEIGHT	LENGTH
S136	10x36	15.0mm	16.4'	325' / 6.2°	9.7 oz.	4.9"
S836	8x36	18.0mm	16.4'	393' / 7.5°	9.7 oz.	4.9"
S105	10x25	14.5mm	16.4'	315' / 6.0°	5.6 oz.	4.4"
S825	8x25	15.0mm	16.4'	378' / 7.2°	5.6 oz.	4.4"

FEATURES

- ▶ SD OPTICAL SYSTEM
- ▶ FULLY MULTI-COATED LENSES
- ▶ RUBBER ARMOR
- ▶ UTILITY CLIP
- ▶ NITROGEN GAS PURGED
- ▶ WATERPROOF
- ▶ FOGPROOF
- ▶ SHOCKPROOF

For a description of each feature, see page 6.

SOLO® R/T

MONOCULAR



FIND YOUR TARGET. FIND YOUR CALLING.

The incredibly light form factor of our Solo® monocular with a tactical twist, the Solo® R/T monocular features an MRAD-based ranging reticle for accurate range estimation and shot calls. The powerful optical system delivers bright images in a compact, lightweight, and easy-to-handle unit that's both waterproof and fogproof. With an integrated utility clip, it attaches to webbing or other flat-edged surfaces for quick access.

R/T RANGING RETICLE

Uses MRAD-based subtensions and includes silhouettes for quick ranging. The angular measurements allow you to calculate ranges when comparing the reticle to objects of known dimension.

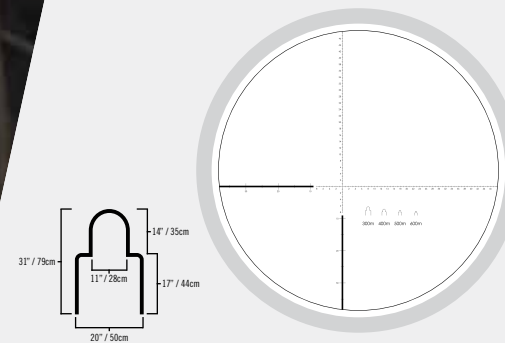

SPECS

SKU	MODEL	EYE RELIEF	CLOSE FOCUS	FIELD OF VIEW 1000 YARDS / DEGREES	WEIGHT	LENGTH
SOL-3608-RT	8x36	18mm	16.4'	393' / 7.5°	10.2 oz.	5.4"

FEATURES

- ▶ SD OPTICAL SYSTEM
- ▶ FULLY MULTI-COATED LENSES
- ▶ RUBBER ARMOR
- ▶ UTILITY CLIP
- ▶ NITROGEN GAS PURGED
- ▶ WATERPROOF
- ▶ FOGPROOF
- ▶ SHOCKPROOF

For a description of each feature, see page 6.





TRAIL BLAZERS

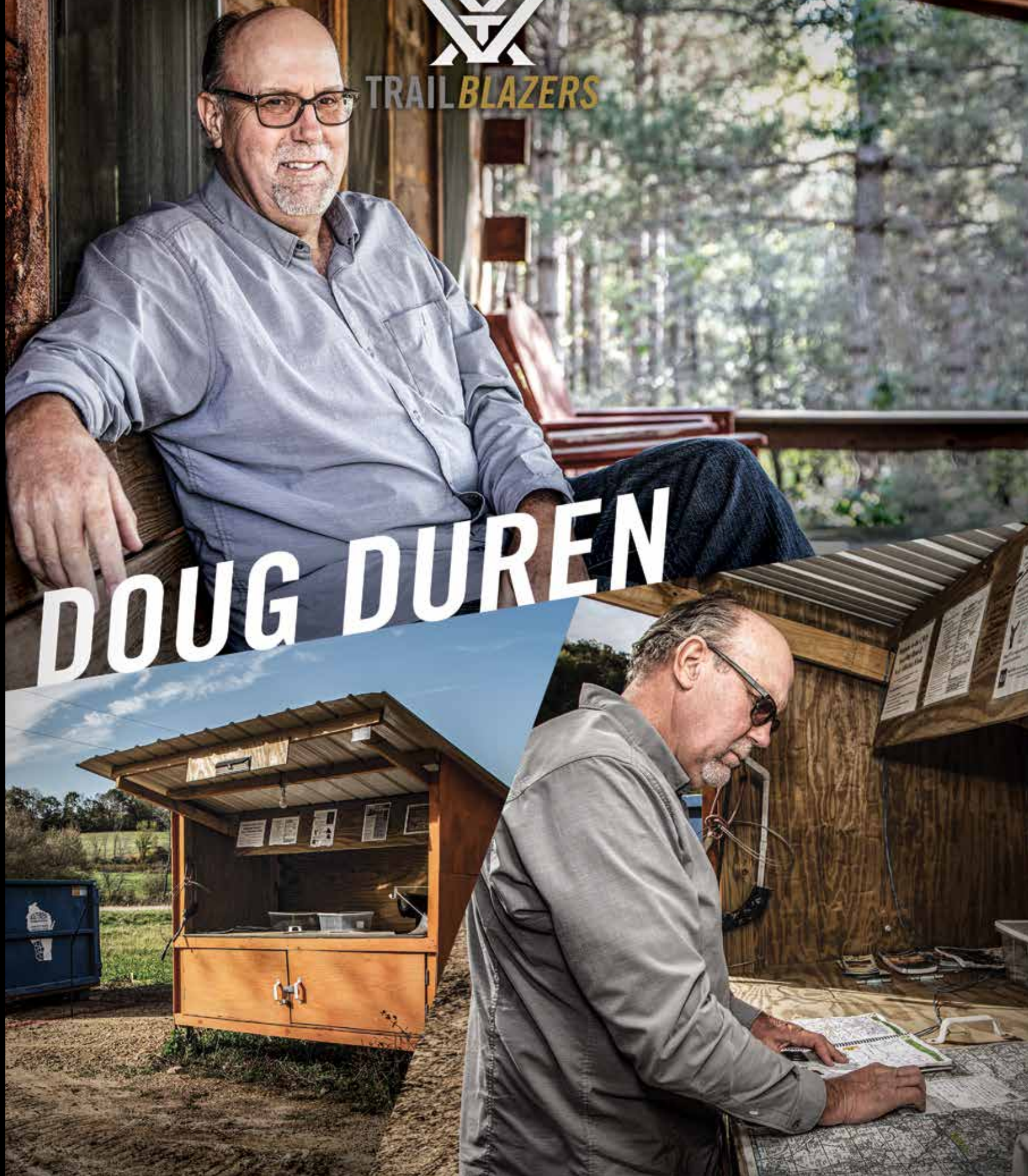

DOUG DUREN

POINTING DISTANCE

LAND STEWARDSHIP, CHRONIC WASTING DISEASE,
AND THE POWER OF THINKING LOCAL WITH DOUG DUREN

It's a sunny afternoon, and Doug Duren has a reason to smile.

Sitting at a table near a window looking out on land that's been in his family for 115 years, he hooks a thumb over his shoulder and points down the road at a kiosk where soon, a dumpster will sit, available cost-free for any local hunter to dispose of their harvested deer carcass and get it tested for Chronic Wasting Disease (CWD). "Where we are today, from where we were one year ago with this program? We had a dozen dumpsters out in Southern Wisconsin, and half of those were ones I sponsored." He looks out the window, down the road. "This year, we're set to have twice as many."

The DNR just called, wanting Duren to be the first to know: This year, they'd provide cost sharing on the "Adopt-a-Dumpster" program Duren has become the face of in Wisconsin. "And why?" Duren asks. "Because people have been asking; people have been talking. It starts with conversation and citizen involvement."

How that conversation began, and how it has become a movement, generating momentum for change in the seven states and three provinces that've already contacted Duren to learn more about the dumpster program is, really, a story about land.

He points out the door across the room, through an entryway and an old screen door, a large hole in the screen. "I don't remember a time in my life when I didn't work out here. My earliest memories are here, sitting up on the tractor and just going along with my dad and my siblings. Playing in the crick down there," he says, pointing to the right, to the small creek that hugs the winding road into town. "I've got the dirt from this farm under my fingernails and in my blood."

In the next room over, deer heads of various sizes cover the walls. He points at the room. "I could tell you a story about every deer in that room; every one of them has a story and every one of them is a memory. There's one hanging in there that was the last time my brother and I hunted together."

He points to the old screen door again. "Twenty-five years ago, my brother went through that screen with his rifle, hurrying out after a deer. That January, he died in a car crash right down the road there," Duren says, pointing out the window, over the creek and past the kiosk. "That's why that door is the same way now. It's a memory of him and our last hunt together. There's a lot of stuff around here that's like that."

His family's land is no different, nearly every place on this farm has a memory. But Duren is quick to point out a pillar of his conservation ethic: "I'm nostalgic for certain things. I miss our old tractors, the old International Harvesters we used to run. But here's the thing," he says, pointing out the window to the rolling hills, the tall stands of trees that have surrounded generations of his family. "A lot of folks buy land around here and they want to preserve it. Well, preservation is not conservation."

Around here, if you don't know Duren for his work on battling CWD, you know him as a champion of conservation. He has been part of the My Wisconsin Woods Woodland Advocate Program and, in that ongoing role, he helps landowners in Wisconsin's Driftless region understand the importance of managing their land.

"Part of what we have to do is get people to understand how things are connected. Around here, if something floats down the crick from your neighbor's land, you go up there and say, 'What the hell?' And you can't be a hypocrite; you keep your crick clean. And as long as you're thinking that way, it seems to me that there should be constant improvement."

For Duren, that improvement begins with picking up the pieces left by a sea of change at the local level. As agriculture in the area followed the national trend toward big, mega-farms, small family farms like the Duren's have all but disappeared. Into that vacuum, landowners from, as Duren calls it, "away," bought properties for something other than farming. "When I was a kid, people didn't own land to primarily hunt it or recreate on it. I'm not saying this is a bad thing, and in fact, it can be a very good thing because people who have land for hunting and recreating tend to be interested in conservation," Duren said.

Local, or from "away," Duren has made it a priority to help other landowners understand the responsibility of owning property in the Driftless region. He makes himself available, in most cases cost-free, to other landowners, answering questions and having conversations.

Constant improvement; starting with your own land and working out. Which brings him back to dumpsters, the future of deer management, an incredibly complex disease with a complex history. When Duren talks about CWD, he leans into it, elbows on knees. "I was listening to all this stuff, all these big ideas about controlling CWD, but if we're not doing basic hygiene, all the rest of it is zippity-doo-dah." He points down the road, to the kiosk. "It didn't make sense that we were leaving infectious material on the landscape. So, what can I do in my life and on my farm to help with that?" He leans back in his chair and turns his palms up and nods out the window. "Well, I can have a carcass dumpster and make sure carcasses are properly disposed of."

He leans forward, pinching a tissue out of a box on a cluttered desk. "I don't do this," he holds the tissue up to his face, pretends to blow his nose, then wads the tissue up and throws it on the floor. "So, now you come by and pick it up? That doesn't make sense at all. Now you're going to get sick."

He picks up the tissue, walks to a small waste basket in the adjoining bathroom and drops it inside. Sits back in his chair, pointing at the waste basket. "What did I just do? I did something for myself and I did something for you. The dumpster program is the same idea. If we're not going to do anything else, can we at least agree it's not a good idea to leave the fricking Kleenex on the floor?"

On the surface, the program gives hunters the opportunity to dispose of their harvested deer carcass and, if they choose, to get the deer tested for CWD. Duren points again, out the window, "Last year was the first time we had a dumpster here. We had approximately 200 deer carcasses before it was taken. Guess how many got tested for CWD? Less than 50. And that's okay. Because here's what happened: People pulled in, and I'd say, 'Hey, you wanna get that deer tested?' Some people'd say, 'I don't know, I don't care.' And I'd say, 'Cool. But let me tell you this: If that deer is positive, we just kept it off the landscape. And that's great.'"

Outside, cattle bellow and Duren smiles again, quiet for a time. He says, "Years ago, I came home from college to take a break from school. I talked to a lady in town who was a neighbor of ours and she says, 'What are you going to do now?' and I said, 'Well, I'm probably going to run the farm for a while.' And she said to me, and I'll never forget this, 'Well, You'll never get rich farming. But it's a nice life.'"

He smiles again and leans back in his chair and points out the door with the hole in the screen, at the farm that taught him to care, deeply, for the land and the wild things on it. "And the thing that I would always say about this place is it was a nice life. It's always been a nice life to be here and to be a part of it."



IN PURSUIT OF OUR

In the grind of your daily life, it's easy to forget you're part of a thriving community of people who share your interests and your passions. A love of the outdoors, of competition, and of spending time with friends and family unites us all. But the connection goes even deeper.

Since 1937, when congress passed the Pittman-Robertson Federal Aid in Wildlife Restoration Act, hunters and shooters have become the driving force behind keeping America's natural places open and accessible for all. Funds generated through the sale of hunting and fishing licenses, and the excise taxes paid by gun and ammunition manufacturers, form the backbone of funding for state wildlife agencies. This provides every American the opportunity to pursue solitude and adventure in places that have spoken to generations before them.



BETTER NATURE



At Vortex®, it's our passion to be a part of this community by offering products that enrich your experiences at the range and in the field, content that informs and inspires, and by supporting the ambassadors who devote their lives to the lifestyle we all love so much.

Together — as hunters, recreational shooters, competition shooters, and lovers of the outdoors — we're all committed to maintaining the values and the wilderness that have helped form our country's past and will continue to inspire and inform our future.

TOGETHER. WE KEEP AMERICA WILD.



SPOTTING SCOPES





RAZOR® HD

SPOTTING SCOPES

VORTEXOPTICS.COM



RAZOR® HD

SPOTTING SCOPE



THE EYES FEED THE WOLF.

One look through the eyepiece and you know: This is how a spotting scope should be. Setting the standard in high-end optical technologies, precision craftsmanship, and ultra-sleek functionality, the Razor® HD is one of the finest scopes on the market. Advanced optical elements eliminate aberrations for distortion-free, flat-field images with unmatched, edge-to-edge sharpness, as well as remarkable clarity, resolution, and color accuracy. Hunters, shooters, and outdoor enthusiasts who need a premium spotter that performs at the highest level have found their match.

Note – Custom-fitted neoprene case included.

SPECS

SKU	MODEL	EYEPiece POSITION	EYE RELIEF	CLOSE FOCUS	FIELD OF VIEW 1000 YARDS / DEGREES	WEIGHT	LENGTH
RS-85A	27-60x85	Angled	17.0mm - 16.7mm	16.4'	117' - 68' / 2.2° - 1.3°	65.6 oz.	15.5"
RS-85S		Straight					16.2"
RS-65A	22-48x65	Angled	17.0mm - 16.7mm	26.2'	138' - 84' / 2.7° - 1.6°	56.8 oz.	14.8"
RS-65S		Straight					15.6"
RZR-50A1	11-33x50	Angled	19.0mm - 16.0mm	6.6'	191' - 96' / 3.6° - 1.8°	25.0 oz.	10.3"
RZR-50S1		Straight					11.0"

FEATURES

- ▶ HD OPTICAL SYSTEM
- ▶ XR™ PLUS LENS COATINGS
- ▶ DIELECTRIC PRISM COATINGS
- ▶ PLASMA TECH
- ▶ ARMORTEK®
- ▶ RUBBER ARMOR
- ▶ ARGON GAS PURGED
- ▶ WATERPROOF
- ▶ FOGPROOF

For a description of each feature, see page 6.



VIPER® HD

SPOTTING SCOPE



BUILT-IN SUNSHADE

ADJUSTABLE EYECUP

HELICAL FOCUS



CROSS EVERYTHING OFF YOUR LIST.

We love a bit of reverse sticker shock, and the Viper® HD is a high-end spotter without the high-end price tag. It proves you no longer need to drop four figures to get premium performance and features, with an HD optical system bringing even the finest, most distant details in for a closer look. Built to withstand the harshest rain, snow, heat, or abuse you can dish out, the Viper® HD is a perfect fit whether you're in the hills or at the range.

Note – Custom-fitted neoprene case included.

SPECS

SKU	MODEL	EYEPiece POSITION	EYE RELIEF	CLOSE FOCUS	FIELD OF VIEW 1000 YARDS / DEGREES	WEIGHT	LENGTH
V502	20-60x85	Angled	19.6mm - 17.8mm	36'	101 - 50' / 1.9 - 1.0°	76.6 oz.	17.5"
V503		Straight					18.0"
V500	15-45x65	Angled	19.6mm - 17.8mm	23'	136.5 - 67.8' / 2.6 - 1.3°	59.0 oz.	14.0"
V501		Straight					14.6"

FEATURES

- ▶ HD OPTICAL SYSTEM
- ▶ XR™ PLUS LENS COATINGS
- ▶ DIELECTRIC PRISM COATINGS
- ▶ ARMORTEK®
- ▶ RUBBER ARMOR
- ▶ ARGON GAS PURGED
- ▶ WATERPROOF
- ▶ FOGPROOF

For a description of each feature, see page 6.



DIAMONDBACK®

SPOTTING SCOPES

VORTEXOPTICS.COM



DIAMONDBACK®

SPOTTING SCOPE



FEAST YOUR EYES.

Some classics just keep getting better with age. With Diamondback® blood in its veins, you know this spotter is going to deliver outstanding performance at an outstanding price, making it a heavy hitter in a lightweight package. The Diamondback® line ensures a bright, crisp image throughout the magnification range and its rugged construction stands up to rough use in the field with a waterproof, fogproof build.

Note – Custom-fitted neoprene case included.

SPECS

SKU	MODEL	EYEPIECE POSITION	EYE RELIEF	CLOSE FOCUS	FIELD OF VIEW 1000 YARDS / DEGREES	WEIGHT	LENGTH
DBK-80A1	20-60x80	Angled	20.0mm - 16.5mm	22'	105 - 51' / 2.0 - 1.0°	47.1 oz.	14.8"
DBK-80S1		Straight					15.7"
DBK-60A1	20-60x60	Angled	17.0mm - 14.0mm	20'	114 - 51' / 2.2 - 1.0°	33.8 oz.	14.0"
DBK-60S1		Straight					14.4"

FEATURES

- ▶ XD™ OPTICAL SYSTEM
- ▶ FULLY MULTI-COATED LENSES
- ▶ DIELECTRIC PRISM COATINGS
- ▶ NITROGEN GAS PURGED
- ▶ WATERPROOF
- ▶ FOGPROOF

For a description of each feature, see page 6.

TRIPODS



SUMMIT™ SS-P

Our ultimate backpacking tripod provides the perfect combination of compact size, lightweight design, rugged build, and fast operation. Plus, the split center column allows you to get close to the ground, so you don't get skylined by that wary bull.



PRO GT™

For reliable performance at a great price, look to the Pro GT™. Designed to handle any condition, sturdy anodized legs combined with a rugged, 3-way quick release pan head deliver solid support for your optics.



HIGH COUNTRY™

Smaller, lighter, and more compact than our Pro GT™, the High Country™ is designed for hunting at altitudes where every ounce counts. The variable leg angles and flip lever leg locks make set up a snap.



CAR WINDOW MOUNT

Ready to use in just seconds, the Vortex® Car Window Mount lets you use any vehicle as a blind for viewing and provides compact, solid support for spotting scopes and binoculars.



SUMMIT™ SS QUICK RELEASE PLATE



PRO GT™ QUICK RELEASE PLATE



HIGH COUNTRY™ SS QUICK RELEASE PLATE



SPOTTING SCOPE ACCESSORIES

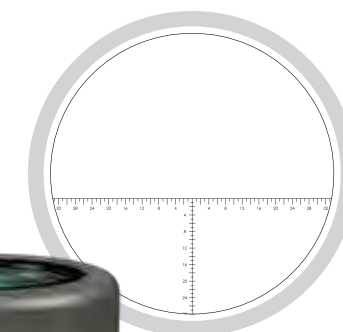

RAZOR® HD RETICLE EYEPIECE

Used with the Razor® HD 85mm spotter, range work, calling shots, and spotter/shooter communication become seamless; it's like having a ruler in your spotting scope. Just like many of our riflescopes, the eyepiece is available in both MOA and MRAD configurations to match the reticle subtension markings, and turret graduations, in your rifle scope.



RAZOR® HD 18X / 22X LER EYEPIECE

Meet your next best range buddy: The fixed-power, Long Eye Relief (LER) eyepiece — made exclusively for Razor® HD 65mm and 85mm spotting scopes — delivers 31mm of eye relief for fast, accurate reads, with 18x on the 65mm, and 22x on the 85mm. Not compatible with the 50mm Razor® HD models.



VIPER® HD 80MM PADDED CASE

This black padded view-through carry case protects both the straight and angled 80mm Viper® HD spotting scopes.



RIFLESCOPE SPECS

Some people see the glass as half full, others as half empty. Then there are the scholarly engineer types who question why the glass is the wrong size for the contents. If you fall into the last category and love to know all the details and specifications, these pages are for you! If you want more details than what you see here, please visit our website at VortexOptics.com.

SKU	MAGNIFICATION X OBJECTIVE LENS	RETICLE OPTIONS	WEIGHT	LENGTH	EYE RELIEF (MAX POWER)	FIELD OF VIEW @ 100 YARDS	TUBE SIZE	TURRET STYLE	ADJUSTMENT GRADUATION	TRAVEL PER ROTATION	ELEVATION TOTAL TRAVEL	WINDAGE TOTAL TRAVEL	PARALLAX IN YARDS
Razor® HD AMG™													
RZR-AMG-5	6-24x50 FFP	EBR-7B MRAD	28.8 oz.	14.96"	3.6"	20.4' - 5.1'	30mm	L-Tec	.1 MRAD	10.0 MRAD	27.5 MRAD	10.0 MRAD	25 - ∞
RZR-AMG-4		EBR-7B MOA							¼ MOA	25.0 MOA	71.0 MOA	34.0 MOA	
Razor® HD Gen III													
RZR-11002	1-10x24 FFP	EBR-9 MRAD	21.5 oz.	10.10"	3.6"	116.0' - 11.7'	34mm	Low Capped	.1 MRAD	10.0 MRAD	30.0 MRAD	30.0 MRAD	100
RZR-11001		EBR-9 BDC MOA							¼ MOA	25.0 MOA	120.0 MOA	120.0 MOA	
Razor® HD Gen II													
RZR-42707	4.5-27x56 FFP	EBR-7C MOA	48.5 oz.	14.40"	3.7"	25.3' - 4.4'	34mm	L-Tec	¼ MOA	25.0 MOA	71.0 MOA	34.0 MOA	32 - ∞
RZR-42708		EBR-7C MRAD							.1 MRAD	10.0 MRAD	28.5 MRAD	10.0 MRAD	
RZR-42709		Horus™ H59™											
RZR-42710		Horus™ Tremor3™											
RZR-31804	3-18x50 FFP	EBR-7C MOA	46.5 oz.	14.40"	3.7"	37.8' - 6.3'	34mm	L-Tec	¼ MOA	25.0 MOA	71.0 MOA	34.0 MOA	25 - ∞
RZR-31805		EBR-7C MRAD							.1 MRAD	10.0 MRAD	28.5 MRAD	10.0 MRAD	
Razor® HD Gen II-E													
RZR-16008	1-6x24	JM-1 MOA	21.5 oz.	10.10"	4.0"	115.2' - 20.5'	30mm	Low Capped	½ MOA	50.0 MOA	150.0 MOA	150.0 MOA	100
RZR-16010		VMR-2 MOA							.2 MRAD	20.0 MRAD	43.0 MRAD	43.0 MRAD	
RZR-16009		VMR-2 MRAD											
Razor® HD													
RZR-52006	5-20x50 FFP	EBR-2B MRAD	37.0 oz.	15.80"	3.9"	22.5' - 5.8'	35mm	Tactical	.1 MRAD	10.0 MRAD	36.0 MRAD	36.0 MRAD	40 - ∞
RZR-52005		EBR-2B MOA							¼ MOA	25.0 MOA	125.0 MOA	125.0 MOA	
Golden Eagle® HD													
TCS-1503	15-60x52	ECR-1 MOA	29.7 oz.	16.10"	3.9"	6.3' - 1.7'	30mm	Target	¼ MOA	10.0 MOA	55.0 MOA	45.0 MOA	15 - ∞
TCS-1501		SCR-1 MOA											
Viper® PST Gen II													
PST-5259	5-25x50 FFP	EBR-7C MRAD	31.2 oz.	15.79"	3.4"	24.1' - 4.8'	30mm	Tactical	.1 MRAD	10.0 MRAD	20.0 MRAD	10.0 MRAD	25 - ∞
PST-5256		EBR-7C MOA							¼ MOA	25.0 MOA	70.0 MOA	35.0 MOA	
PST-5251	5-25x50	EBR-4 MOA	31.2 oz.	15.79"	3.4"	24.1' - 4.8'	30mm	Tactical	¼ MOA	25.0 MOA	70.0 MOA	35.0 MOA	25 - ∞
PST-3159	3-15x44 FFP	EBR-7C MRAD	28.1 oz.	14.30"	3.4"	41.2' - 8.6'	30mm	Tactical	.1 MRAD	10.0 MRAD	22.0 MRAD	11.0 MRAD	20 - ∞
PST-3156		EBR-7C MOA							¼ MOA	25.0 MOA	75.0 MRAD	40.0 MOA	
PST-3151	3-15x44	EBR-4 MOA	28.1 oz.	14.30"	3.4"	41.2' - 8.6'	30mm	Tactical	¼ MOA	25.0 MOA	75.0 MRAD	40.0 MOA	20 - ∞
PST-2105	2-10x32 FFP	EBR-4 MRAD	26.3 oz.	12.64"	3.2"	58.3' - 11.7'	30mm	Tactical	.1 MRAD	10.0 MRAD	26.0 MRAD	26.0 MRAD	20 - ∞
PST-2101		EBR-4 MOA							¼ MOA	25.0 MOA	90.0 MOA	90.0 MOA	
PST-1607	1-6x24	VMR-2 MRAD	22.7 oz.	10.83"	3.8"	112.5' - 18.8'	30mm	Capped	.2 MRAD	16.0 MRAD	46.0 MRAD	46.0 MRAD	100
PST-1605		VMR-2 MOA							½ MOA	50.0 MOA	160.0 MOA	160.0 MOA	
Viper® HST													
VHS-4310	6-24x50	VMR-1 MRAD	22.6 oz.	15.41"	4.0"	17.8' - 5.1'	30mm	Tactical	.1 MRAD	5.0 MRAD	19.0 MRAD	19.0 MRAD	50 - ∞
VHS-4325		VMR-1 MOA							¼ MOA	12.0 MOA	65.0 MOA	65.0 MOA	
VHS-4308	4-16x44	VMR-1 MRAD	20.8 oz.	13.33"	4.0"	27.4' - 7.4'	30mm	Tactical	.1 MRAD	5.0 MRAD	21.0 MRAD	21.0 MRAD	50 - ∞
VHS-4309		VMR-1 MOA							¼ MOA	12.0 MOA	75.0 MOA	75.0 MOA	

SKU	MAGNIFICATION X OBJECTIVE LENS	RETICLE OPTIONS	WEIGHT	LENGTH	EYE RELIEF (MAX POWER)	FIELD OF VIEW @ 100 YARDS	TUBE SIZE	TURRET STYLE	ADJUSTMENT GRADUATION	TRAVEL PER ROTATION	ELEVATION TOTAL TRAVEL	WINDAGE TOTAL TRAVEL	PARALLAX IN YARDS
Viper® HSLR™													
VHS-4315-LR	6-24x50 FFP	XLR MOA	22.4 oz.	15.41"	4.0"	17.8' - 5.1'	30mm	Capped Windage Tactical Elevation	Windage: ¼ MOA Elevation: ½ MOA	Windage: 12 MOA Elevation: 24 MOA	65.0 MOA	42.0 MOA	50 - ∞
VHS-4307-LR	4-16x50	Dead-Hold® BDC	21.4 oz.	13.56"	4.0"	27.4' - 7.4'	30mm	Capped Windage Tactical Elevation			75.0 MOA	50.0 MOA	50 - ∞
Viper® HS™													
VHS-4307	4-16x50	Dead-Hold® BDC	20.4 oz.	13.60"	4.0"	27.4' - 7.4'	30mm	Capped	¼ MOA	12.0 MOA	50.0 MOA	50.0 MOA	50 - ∞
VHS-4305	4-16x44	Dead-Hold® BDC	18.4 oz.	13.41"	4.0"	27.4' - 7.4'	30mm	Capped	¼ MOA	12.0 MOA	50.0 MOA	50.0 MOA	50 - ∞
VHS-4303	2.5-10x44	Dead-Hold® BDC	16.5 oz.	12.00"	4.0"	47.0' - 10.9'	30mm	Capped	¼ MOA	12.0 MOA	86.0 MOA	86.0 MOA	100
Viper®													
VPR-M-06MD	6.5-20x50 PA	Mil-Dot	21.6 oz.	14.44"	3.1"	17.4' - 6.2'	30mm	Tall Capped	¼ MOA	12.0 MOA	65.0 MOA	65.0 MOA	50 - ∞
VPR-M-06BDC		Dead-Hold® BDC							¼ MOA	12.0 MOA	65.0 MOA	65.0 MOA	50 - ∞
Strike Eagle®													
SE-1824-1	1-8x24	AR-BDC2	16.7 oz.	10.00"	3.5"	116.5' - 14.4'	30mm	Capped	½ MOA	44.0 MOA	100.0 MOA	100.0 MOA	100
SE-1624-1	1-6x24	AR-BDC	17.6 oz.	10.50"	3.5"	116.5' - 19.2'	30mm	Capped	½ MOA	40.0 MOA	140.0 MOA	140.0 MOA	100
Diamondback® Tactical													
DBK-10029	6-24x50 FFP	EBR-2C MRAD	24.6 oz.	14.28"	3.9"	18.0' - 4.5'	30mm	Tall Exposed Tactical	0.1 MRAD	6.0 MRAD	19.0 MRAD	19.0 MRAD	10 - ∞
DBK-10028		EBR-2C MOA							¼ MOA	15.0 MOA	65.0 MOA	65.0 MOA	10 - ∞
DBK-10027	4-16x44 FFP	EBR-2C MRAD	23.1 oz.	14.06"	3.8"	26.9' - 6.7'	30mm	Tall Exposed Tactical	0.1 MRAD	6.0 MRAD	25.0 MRAD	25.0 MRAD	20 - ∞
DBK-10026		EBR-2C MOA							¼ MOA	15.0 MOA	85.0 MOA	85.0 MOA	20 - ∞
DBK-10025	4-12x40	VMR-1 MOA	16.2 oz.	14.08"	3.9"	23.6' - 7.9'	1"	Tactical	¼ MOA	12.0 MOA	70.0 MOA	70.0 MOA	100
Diamondback®													
DBK-04-BDC	4-12x40	Dead-Hold® BDC	14.6 oz.	12.00"	3.1"	32.4' - 11.3'	1"	Capped	¼ MOA	15.0 MOA	60.0 MOA	60.0 MOA	100
DBK-03-BDC	3.5-10x50	Dead-Hold® BDC	16.2 oz.	12.50"	3.3"	35.8' - 13.5'	1"	Capped	¼ MOA	15.0 MOA	65.0 MOA	65.0 MOA	100
DBK-M-01P	3-9x40	V-Plex	14.4 oz.	11.61"	3.3"	44.6' - 14.8'	1"	Capped	¼ MOA	15.0 MOA	70.0 MOA	70.0 MOA	100
DBK-01-BDC		Dead-Hold® BDC											
DBK-RIM	2-7x35 Rimfire	V-Plex	14.2 oz.	11.60"	3.1"	64.3' - 19.3'	1"	Capped	¼ MOA	15.0 MOA	100.0 MOA	100.0 MOA	50
DBK-08-BDC	1.75-5x32	Dead-Hold® BDC	12.8 oz.	10.20"	3.5"	68.3' - 23.1'	1"	Capped	¼ MOA	15.0 MOA	125.0 MOA	125.0 MOA	100
Crossfire® II 30mm Tube													
CF2-31045	6-24x50 AO	Dead-Hold® BDC	23.6 oz.	14.50"	4.0"	17.3' - 4.4'	30mm	Capped	¼ MOA	15.0 MOA	40.0 MOA	40.0 MOA	10 - ∞
CF2-31039	4-16x50 AO	Dead-Hold® BDC	23.6 oz.	14.37"	3.7"	25.0' - 7.0'	30mm	Capped	¼ MOA	15.0 MOA	50.0 MOA	50.0 MOA	25 - ∞
CF2-31049	3-12x56 AO	V-Brite®	21.1 oz.	13.46"	3.5"	36.7' - 9.2'	30mm	Capped	¼ MOA	15.0 MOA	60.0 MOA	60.0 MOA	10 - ∞
CF2-31037	1-4x24	V-Brite®	14.8 oz.	9.61"	4.0"	96.1' - 24.1'	30mm	Capped	½ MOA	30.0 MOA	100.0 MOA	100.0 MOA	100
Crossfire® II 1" Tube													
CF2-31033	6-18x44 AO	Dead-Hold® BDC	19.6 oz.	13.78"	3.7"	15.2' - 5.3'	1"	Capped	¼ MOA	15.0 MOA	50.0 MOA	50.0 MOA	10 - ∞
CF2-31029		V-Brite®	20.6 oz.										
CF2-31023	4-12x50 AO	Dead-Hold® BDC	20.6 oz.	14.30"	3.9"	25.7' - 8.4'	1"	Capped	¼ MOA	15.0 MOA	50.0 MOA	50.0 MOA	10 - ∞
CF2-31019	4-12x40 AO	Dead-Hold® BDC	19.2 oz.	13.60"	3.9"	24.7' - 8.4'	1"	Capped	¼ MOA	15.0 MOA	50.0 MOA	50.0 MOA	10 - ∞
CF2-31015	4-12x44	Dead-Hold® BDC	17.2 oz.	13.15"	3.9"	24.7' - 8.4'	1"	Capped	¼ MOA	15.0 MOA	50.0 MOA	50.0 MOA	100
CF2-31013		V-Plex											
CF2-31011	3-9x50	Dead-Hold® BDC	18.4 oz.	12.80"	3.8"	32.0' - 12.9'	1"	Capped	¼ MOA	15.0 MOA	60.0 MOA	60.0 MOA	100
CF2-31027		V-Brite®	18.6 oz.										
CF2-31005	3-9x40	V-Plex	15.0 oz.	11.86"	3.8"	34.1' - 12.6'	1"	Capped	¼ MOA	15.0 MOA	60.0 MOA	60.0 MOA	100
CF2-31007		Dead-Hold® BDC											
CF2-31025	2-7x32 Scout	V-Brite®	16.2 oz.	10.71"	9.5"	18.3' - 5.2'	1"	Capped	¼ MOA	15.0 MOA	60.0 MOA	60.0 MOA	100
CF2-31002		V-Plex											
CF2-31003	2-7x32	Dead-Hold® BDC	14.3 oz.	10.71"	3.9"	42.0' - 12.6'	1"	Capped	¼ MOA	15.0 MOA	60.0 MOA	60.0 MOA	100
CF2-31001		V-Plex	50										
CF2-31001R	2-7x32 Rimfire	V-Plex	14.3 oz.	10.71"	3.9"	42.0' - 12.6'	1"	Capped	¼ MOA	15.0 MOA	60.0 MOA	60.0 MOA	50

RIFLESCOPE DIMENSIONS

These dimensions will help determine which rings and flip clips will work best for each scope. For more details, please visit the riflescope specification pages on our website.

Note: Dimensions measured in inches.

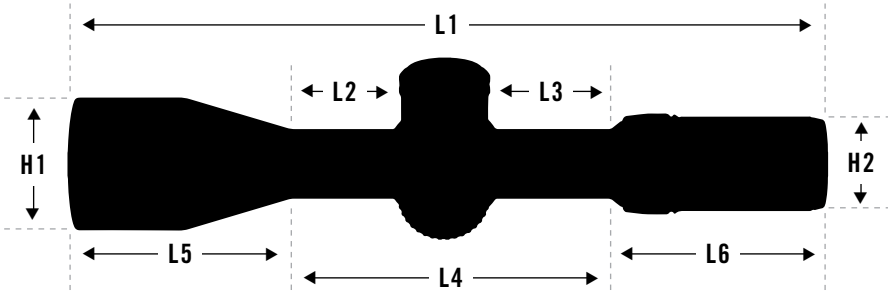

MODEL	LENGTH						HEIGHT	
	L1	L2	L3	L4	L5	L6	H1	H2
Razor® HD AMG®								
6-24x50	14.96	2.15	2.28	6.00	5.04	3.93	2.32	1.74
Razor® HD Gen III								
1-10x24	10.10	2.00	2.50	6.70	0.40	3.40	1.33	1.81
Razor® HD Gen II								
4.5-27x56	14.40	1.96	2.17	6.11	4.13	4.10	2.55	1.81
3-18x50	14.40	1.96	2.17	6.11	4.13	4.10	2.32	1.81
Razor® HD Gen II-E								
1-6x24	10.10	2.50	1.50	5.67	0.85	3.60	1.29	1.81
Razor® HD								
5-20x50	15.80	2.90	2.50	6.90	4.90	3.90	2.33	1.74
Golden Eagle® HD								
15-60x52	16.10	3.50	2.28	7.50	5.51	3.09	2.41	1.73
Viper® PST Gen II								
5-25x50	15.79	2.37	2.58	6.59	5.60	3.59	2.30	1.81
3-15x44	14.30	2.32	2.59	6.56	4.15	3.59	2.08	1.81
2-10x32	12.64	2.36	2.53	6.54	2.52	3.59	1.61	1.81
1-6x24	10.83	3.00	2.19	6.85	0.50	3.44	1.29	1.81
Viper® HST								
6-24x50	15.41	2.60	2.58	6.52	5.30	3.60	2.26	1.65
4-16x44	13.33	2.10	2.17	5.61	4.11	3.60	2.03	1.65
Viper® HSLR								
6-24x50	15.41	2.60	2.58	6.52	5.30	3.60	2.26	1.65
4-16x50	13.56	2.10	2.21	5.65	4.31	3.60	2.26	1.65
Viper® HS								
4-16x50	13.60	2.10	2.23	5.67	4.33	3.60	2.27	1.65
4-16x44	13.41	2.13	2.19	5.63	4.20	3.60	2.03	1.65
2.5-10x44	12.00	2.07	2.08	5.47	2.90	3.60	2.03	1.65
Viper®								
6.5-20x50 PA	14.44	2.80	2.20	6.37	4.65	3.24	2.27	1.72

MODEL	LENGTH						HEIGHT	
	L1	L2	L3	L4	L5	L6	H1	H2
Strike Eagle®								
1-8x24	10.00	2.88	1.98	6.45	—	3.43	1.20	1.66
1-6x24	10.50	2.84	2.13	6.53	—	3.90	1.20	1.70
Diamondback® Tactical								
4-12x40	14.08	1.90	2.15	5.30	5.30	3.43	1.86	1.71
Diamondback® Tactical FFP								
6-24x50	14.28	2.30	2.70	6.56	3.98	3.77	2.25	1.73
4-16x44	14.06	2.24	2.70	6.43	3.83	3.77	2.01	1.73
Diamondback®								
4-12x40	12.00	2.46	2.15	5.85	3.00	3.10	1.89	1.69
3.5-10x50	12.50	2.15	2.10	5.48	3.85	3.10	2.29	1.69
3-9x40	11.61	2.10	2.10	5.40	3.07	3.10	1.89	1.69
2-7x35 Rimfire	11.60	1.83	2.10	5.16	3.35	3.10	1.72	1.69
1.75-5x32	10.20	1.90	1.96	5.10	1.90	3.10	1.55	1.69
Crossfire® II								
6-24x50 AO	14.50	1.97	2.60	5.90	5.00	3.60	2.52	1.73
6-18x44 AO	13.78	1.97	2.20	5.40	4.55	3.79	2.30	1.61
4-16x50 AO	14.37	1.90	2.30	5.60	5.16	3.60	2.52	1.73
4-12x50 AO	14.30	2.20	2.20	5.66	5.07	3.56	2.54	1.73
4-12x40 AO	13.60	2.25	2.02	5.50	4.06	3.32	2.16	1.68
4-12x44	13.15	2.30	1.90	5.50	4.00	3.60	2.01	1.71
3-12x56 AO	13.46	1.57	2.05	5.00	5.00	3.54	2.80	1.73
3-9x50	12.80	2.00	1.80	5.10	4.10	3.65	2.27	1.73
3-9x40	11.86	2.10	2.10	5.39	3.15	3.60	1.89	1.68
2-7x32 Scout	10.71	1.86	1.54	4.63	3.10	2.90	1.53	1.61
2-7x32	10.71	1.86	1.54	4.63	3.10	2.90	1.53	1.61
2-7x32 Rimfire	10.71	1.86	1.54	4.63	3.10	2.90	1.53	1.61
1-4x24	9.61	2.78	1.90	6.17	—	3.44	1.18	1.73

RED DOT SPECS

SKU	MAGNIFICATION	RETICLE OPTION	DOT SIZE	WEIGHT	LENGTH	EYE RELIEF	FIELD OF VIEW @ 100 YARDS	ADJUSTMENT GRADUATION	ELEVATION TOTAL TRAVEL	WINDAGE TOTAL TRAVEL	PARALLAX (YARDS)	BATTERY
Razor® AMG® UH-1™												
RZR-AMG-3	1x	Bright Red	1 MOA	11.8 oz.	3.6"	Unlimited	—	½ MOA	100 MOA	16 MOA	Parallax Free See website for details	CR123A (Included) LFP123A
Sparc® AR												
SPC-AR2	1x	Bright Red	2 MOA	7.5 oz.	2.9"	Unlimited	—	1 MOA	90 MOA	90 MOA	Parallax Free	AAA
Strikefire® II												
SF-BR-504	1x	Bright Red	4 MOA	7.2 oz.	5.6"	Unlimited	—	½ MOA per click 25 MOA per rotation	100 MOA	100 MOA	Parallax Free	CR2
SF-RG-501		Red/Green										
Crossfire®												
CF-RD2	1x	Bright Red	2 MOA	5.2 oz.	2.5"	Unlimited	—	1 MOA	100 MOA	100 MOA	Parallax Free	CR2032
Razor®												
RZR-2001	1x	Bright Red	3 MOA	1.3 oz.	1.8"	Unlimited	—	1 MOA	170 MOA	114 MOA	Parallax Free	CR2032
RZR-2003			6 MOA									
Viper®												
VRD-6	1x	Bright Red	6 MOA	1.0 oz.	1.8"	Unlimited	—	1 MOA	120 MOA	120 MOA	Parallax Free	CR2032
Venom®												
VMD-3106	1x	Bright Red	6 MOA	1.1 oz.	1.9"	Unlimited	—	1 MOA	130 MOA	100 MOA	Parallax Free	CR1632
VMD-3103			3 MOA									
Spitfire®												
SPR-1303	3x	EBR-556B MOA	—	15.4 oz.	5.5"	2.8"	31.5'	½ MOA	120 MOA	120 MOA	100	CR2032
Spitfire® AR												
SPR-200	1x	DRT MOA	—	11.2 oz.	4.3"	3.8"	79.0'	½ MOA	120 MOA	120 MOA	Parallax Free	AAA

RANGEFINDER SPECS

SKU	MAGNIFICATION	OPTICAL LENS DIAMETER	EYE RELIEF	FIELD OF VIEW 1000 YARDS / DEGREES	MAX. RANGE	TREE RANGE	DEER RANGE	MIN. RANGE	WEIGHT	LENGTH X HEIGHT
Razor® HD 4000										
LRF-250	7x	25mm	16mm - 19mm	341.25' / 6.5°	4000 yd.	2500 yd.	2200 yd.	5 yd.	9.9 oz.	4.5" x 3.1"
Ranger®										
RRF-181	6x	22mm	17mm	315' / 6.0°	1800 yd.	1000 yd.	900 yd.	10 yd.	7.7 oz.	3.9" x 3.0"
Impact®										
LRF100	6x	20mm	15mm	341' / 6.5°	850 yd.	550 yd.	400 yd.	5 yd.	5.5 oz.	3.0" x 3.8"
Fury® HD 5000										
LRF301	10x	42mm	16mm	321' / 6.1°	5000 yd.	2400 yd.	1600 yd.	5 yd.	32.3 oz.	5.0" x 5.75"



BINOCULAR SPECS

SKU	MODEL	INTERPUPILLARY DISTANCE	EYE RELIEF	CLOSE FOCUS	FIELD OF VIEW 1000 YARDS / DEGREES	WEIGHT	HEIGHT X WIDTH
Razor® UHD							
RZB-3104	18x56	56mm - 76mm	18.0mm	10.0'	194' / 3.7°	41.6 oz.	8.3" x 6.1"
RZB-3103	12x50	56mm - 76mm	17.0mm	6.6'	288' / 5.5°	36.1 oz.	7.6" x 5.8"
RZB-3102	10x42	56mm - 76mm	16.7mm	4.5'	346' / 6.6°	32.2 oz.	7.0" x 5.6"
RZB-3101	8x42	56mm - 76mm	16.7mm	4.5'	420' / 8.0°	32.2 oz.	7.0" x 5.6"
Razor® HD							
RZB-2104	12x50	57mm - 74mm	15.5mm	10.0'	285' / 5.4°	28.7 oz.	6.8" x 5.1"
RZB-2103	10x50	57mm - 74mm	16.5mm	10.0'	315' / 6.0°	28.1 oz.	6.8" x 5.1"
RZB-2102	10x42	55mm - 75mm	16.5mm	6.0'	362' / 6.9°	24.8 oz.	5.9" x 5.1"
RZB-2101	8x42	55mm - 75mm	17.5mm	6.0'	388' / 7.4°	24.2 oz.	5.9" x 5.1"
Viper® HD							
V203	12x50	56mm - 75mm	16.0mm	9.5'	288' / 5.5°	28.8 oz.	6.5" x 5.2"
V202	10x50	56mm - 75mm	16.0mm	9.5'	346' / 6.6°	28.4 oz.	6.5" x 5.2"
V201	10x42	56mm - 75mm	17.0mm	6.5'	341' / 6.5°	24.9 oz.	5.6" x 4.9"
V200	8x42	56mm - 75mm	18.0mm	6.5'	409' / 7.8°	24.5 oz.	5.6" x 4.9"
Diamondback® HD							
DB-217	12x50	60mm - 75mm	14.0mm	6.0'	271' / 5.2°	28.9 oz.	6.4" x 5.3"
DB-216	10x50	60mm - 75mm	17.0mm	6.0'	315' / 6.0°	30.0 oz.	6.6" x 5.3"
DB-215	10x42	55mm - 73mm	15.0mm	5.0'	330' / 6.3°	21.3 oz.	5.7" x 5.1"
DB-214	8x42	55mm - 73mm	17.0mm	5.0'	393' / 7.5°	21.8 oz.	5.7" x 5.1"
DB-213	10x32	57mm - 73mm	14.0mm	6.0'	340' / 6.5°	16.0 oz.	4.4" x 5.0"
DB-212	8x32	57mm - 73mm	16.0mm	5.0'	426' / 8.1°	15.9 oz.	4.4" x 4.6"
DB-211	10x28	55mm - 72mm	16.0mm	6.0'	273' / 5.1°	13.5 oz.	4.6" x 4.5"
DB-210	8x28	55mm - 72mm	18.0mm	6.0'	332' / 6.2°	14.0 oz.	4.6" x 4.5"
Crossfire® HD							
CF-4314	12x50	60mm - 76mm	15.0mm	6.0'	273' / 5.2°	29.5 oz.	6.6" x 5.3"
CF-4313	10x50	60mm - 76mm	17.0mm	6.0'	320' / 6.1°	30.4 oz.	6.7" x 5.3"
CF-4312	10x42	58mm - 75mm	15.0mm	6.0'	325' / 6.2°	23.0 oz.	6.0" x 5.2"
CF-4311	8x42	58mm - 75mm	17.0mm	6.0'	393' / 7.5°	23.8 oz.	6.25" x 5.2"
Kaibab® HD							
KAI-5618	18x56	60mm - 76mm	16.4mm	19.8'	194' / 3.7°	43.5 oz.	7.7" x 5.7"
Vulture® HD							
VR-1556	15x56	59mm - 74mm	15.0mm	15.0'	226' / 4.3°	43.6 oz.	7.6" x 5.8"
Raptor®							
R310	10x32	50mm - 70mm	13.0mm	15.0'	339' / 6.3°	17.6 oz.	4.5" x 5.7"
R385	8.5x32	50mm - 70mm	14.0mm	15.0'	390' / 7.4°	17.3 oz.	4.5" x 5.7"
Vanquish®							
VNQ-1026	10x26	57mm - 71mm	16.0mm	7.6'	294' / 5.6°	12.7 oz.	4.7" x 4.4"
VNQ-0826	8x26	57mm - 71mm	15.0mm	7.6'	352' / 6.7°	12.7 oz.	4.7" x 4.4"

SKU	MODEL	INTERPUPILLARY DISTANCE	EYE RELIEF	CLOSE FOCUS	FIELD OF VIEW 1000 YARDS / DEGREES	MAX. RANGE	TREE RANGE	DEER RANGE	MIN. RANGE	WEIGHT	HEIGHT X WIDTH
Fury® HD 5000											
LRF301	10x42	58mm - 72mm	16.0mm	18.5'	321' / 6.1°	5000 yd.	2400 yd.	1600 yd.	5 yd.	32.3 oz.	5.75" x 5.0"

MONOCULAR SPECS

SKU	MODEL	EYE RELIEF	CLOSE FOCUS	FIELD OF VIEW 1000 YARDS / DEGREES	WEIGHT	LENGTH
RECCE Pro® HD						
RP-100	8x32	14.5mm	5.0'	400' / 7.6°	11.0 oz.	6.2"
Recon® R/T						
RT155	15x50	16.0mm	12.0'	215' / 4.1°	15.2 oz.	7.0"
Solo®						
S136	10x36	15.0mm	16.4'	325' / 6.2°	9.7 oz.	4.9"
S836	8x36	18.0mm	16.4'	393' / 7.5°	9.7 oz.	4.9"
S105	10x25	14.5mm	16.4'	315' / 6.0°	5.6 oz.	4.4"
S825	8x25	15.0mm	16.4'	378' / 7.2°	5.6 oz.	4.4"
Solo® R/T						
SOL-3608-RT	8x36	18.0mm	16.4'	393' / 7.5°	10.2 oz.	5.4"

SPOTTING SCOPE SPECS

SKU	MODEL	EYEPIECE POSITION	EYE RELIEF	CLOSE FOCUS	FIELD OF VIEW 1000 YARDS / DEGREES	WEIGHT	LENGTH
Razor® HD							
RS-85A	27-60x85	Angled	17.0mm - 16.7mm	16.4'	117 - 68' / 2.2 - 1.3°	65.6 oz.	15.5"
RS-85S		Straight					16.2"
RS-65A	22-48x65	Angled	17.0mm - 16.7mm	26.2'	138 - 84' / 2.7 - 1.6°	56.8 oz.	14.8"
RS-65S		Straight					15.6"
RZR-50A1	11-33x50	Angled	19.0mm - 16.0mm	6.6'	191 - 96' / 3.6 - 1.8°	25.0 oz.	10.3"
RZR-50S1		Straight					11.0"
Viper® HD							
V502	20-60x85	Angled	19.6mm - 17.8mm	36.0'	101 - 50' / 1.9 - 1.0°	76.6 oz.	17.5"
V503		Straight					18.0"
V500	15-45x65	Angled	19.6mm - 17.8mm	23.0'	136.5 - 67.8' / 2.6 - 1.3°	59.0 oz.	14.0"
V501		Straight					14.6"
Diamondback®							
DBK-80A1	20-60x80	Angled	20.0mm - 16.5mm	22.0'	105 - 51' / 2.0 - 1.0°	47.1 oz.	14.8"
DBK-80S1		Straight					15.7"
DBK-60A1	20-60x60	Angled	17.0mm - 14.0mm	20.0'	114 - 51' / 2.2 - 1.0°	33.8 oz.	14.0"
DBK-60S1		Straight					14.4"

TRIPOD SPECS

SKU	MODEL	WEIGHT	MAX. LOAD	HEIGHT MIN. - MAX.	FOLDED DIMENSIONS	LEG SECTIONS	LEG ANGLES	LEG LOCKS	HEAD DESIGN
ST-5	Summit™ SS-P	2.0 lb.	5.0 lb.	6.3" - 54.5"	14.0" x 4.5"	5	3	Twist	Pan
PRO-2	Pro GT™	4.4 lb.	10.0 lb.	23.3" - 67.1"	25.0" x 5.0"	3	3	Flip-up	Pan
HC-2	High Country™	2.2 lb.	5.0 lb.	15.0" - 52.3"	21.0" x 3.8"	4	3	Lever	Ball

RETICLES

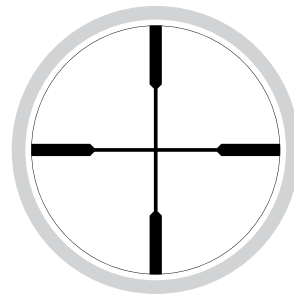

V-PLEX

The V-Plex is a popular, all-purpose hunting reticle intended for a wide variety of applications.

Diamondback®	p. 45
Crossfire® II	p. 49

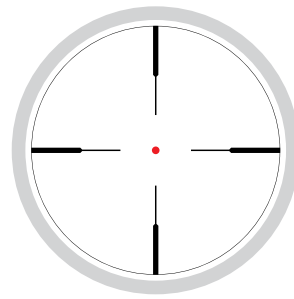

V-BRITE®

GLASS-ETCHED ILLUMINATED CENTER DOT

Uses the V-Plex format with battery-powered electronics to illuminate the center dot for better low-light performance. Perfect for hunters and shooters during extra-low-light conditions.

Crossfire® II	p. 47 / p. 49
---------------	---------------

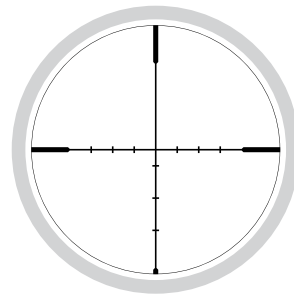

DEAD-HOLD® BDC

Customized hashmark design helps eliminate guesswork on holdover and windage corrections. Good for hunting and shooting at varying ranges, where estimating holdover is a concern.

Viper® HSLR™ / HS™	p. 37
Viper®	p. 39
Diamondback®	p. 45
Crossfire® II	p. 47 / p. 49

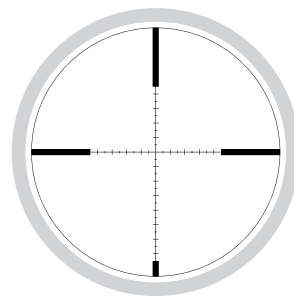

VMR-1 MOA/MRAD

The VMR-1 is a second focal plane, hashmarked reticle offering accurate holdovers and ranging capability at extended distances. Its simple, intuitive design gives just enough of the information hunters and shooters need while maintaining a clean, clutter-free sight picture.

Viper® HST™	p. 35
Diamondback® Tactical	p. 43

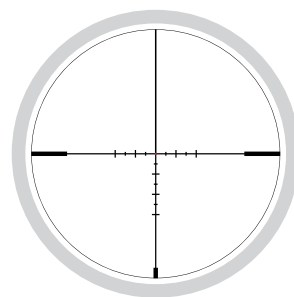

VMR-2 MOA/MRAD

ILLUMINATED CENTER DOT

The VMR-2 is a second focal plane reticle designed specifically for low-power variable optics. A center illuminated dot makes for fast acquisition on 1x, while hashmarks on the lower and horizontal stadia allow for ranging, holdover, and windage corrections on high power.

Razor® HD Gen II-E	p. 27
Viper® PST™ Gen II	p. 33

RETICLES

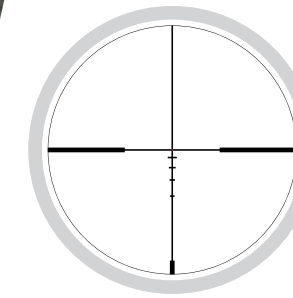

JM-1 BDC

ILLUMINATED CENTER DOT

Simple, intuitive, and fast. The Vortex®-exclusive JM-1 reticle with illuminated center dot was designed with input from world-renowned competitive shooter, instructor, and gunsmith Jerry Miculek. The JM-1 facilitates rapid, accurate shooting at distances from point blank to 600 yards.

Razor® HD Gen II-E	p. 27
--------------------	-------

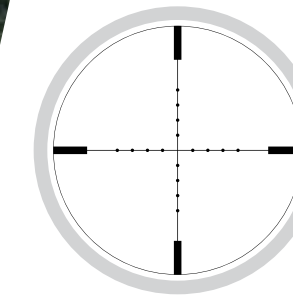

MIL DOT

The Mil Dot is the original tactical reticle with a long history of use as a rangefinder for snipers, when electronic handheld units were not available.

Viper®	p. 39
--------	-------

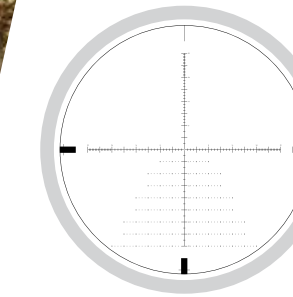

XLR MOA

The XLR is a hashmarked, MOA-based, long-range reticle with wind drift dots and 1 MOA wind reference subtensions. Great for long-range shooters who prefer to dial for bullet-drop and hold for wind at distance.

Viper® HSLR™	p. 37
--------------	-------

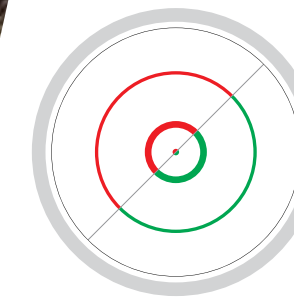

DRT

Designed for rapid shooting at close distances, the dual ring design pulls the eye into instant alignment with the reticle center and target.

Spitfire™ AR	p. 69
--------------	-------

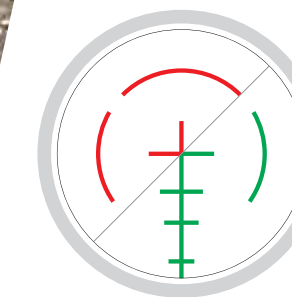

EBR-556B

Designed around the 5.56x45 cartridge, this BDC reticle aids in rapid shooting at both near and far distances while providing holdover and ranging references from 0-500 yards.

Spitfire™ 3X	p. 68
--------------	-------

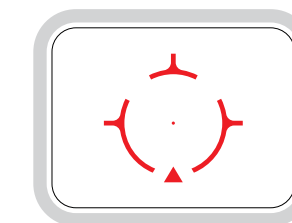

EBR-CQB

The clean, highly versatile, purpose-built reticle creates optimal target engagement in a wide range of scenarios.

Razor® AMG® UH-1®	p. 59
-------------------	-------

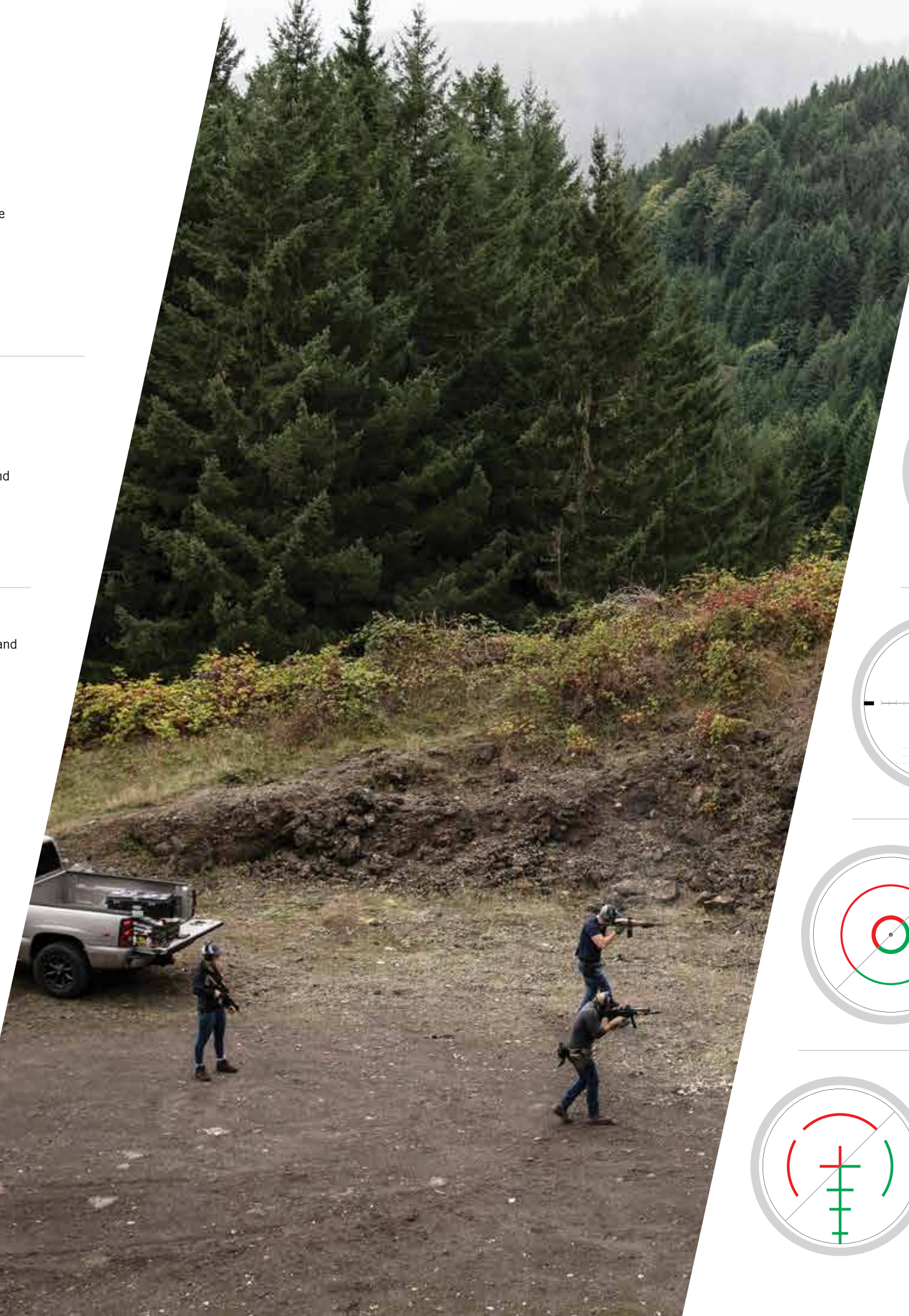

RETICLES

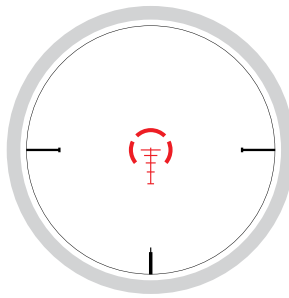

AR-BDC
GLASS-ETCHED ILLUMINATED
A glass-etched, illuminated, second focal plane reticle with fast acquisition on 1x and quick ranging references for silhouette-sized targets.

Strike Eagle® p. 41

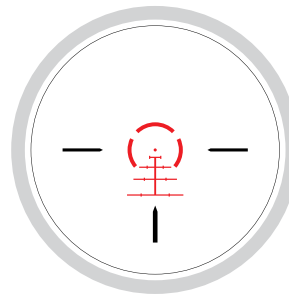

AR-BDC2
GLASS-ETCHED ILLUMINATED
A glass-etched, illuminated, second focal plane reticle with center dot and surrounding halo for red-dot quickness and built-in ranging references.

Strike Eagle® p. 41

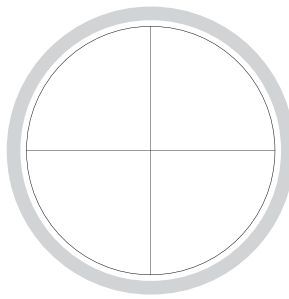

SCR-1
GLASS-ETCHED
With ultra-fine reticle thickness, the SCR-1 is a second focal plane reticle designed specifically for bench rest and F-Class shooters who need to be as precise at long-range as possible with minimal target coverage by the reticle.

Golden Eagle® HD p. 31

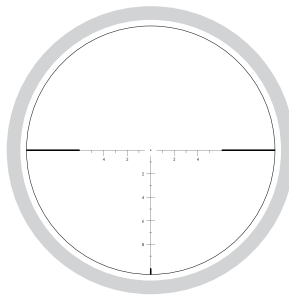

ECR-1 MOA
GLASS-ETCHED
Slightly thicker than the SCR-1 with additional numbered subtensions and a fine center aiming dot, the ECR-1 is a second focal plane optic designed specifically for bench rest and F-Class shooters.

Golden Eagle® HD p. 31

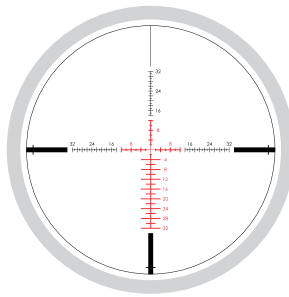

EBR-4 MOA/MRAD
GLASS-ETCHED ILLUMINATED
The EBR-4 is a second focal plane ranging reticle with subtension lines for ranging and holdovers. A fine, precise center crosshair is complimented by wide hashmarks on the lower stadia for quick windage corrections, despite the lack of a full windage tree.

Viper® PST™ Gen II p. 33

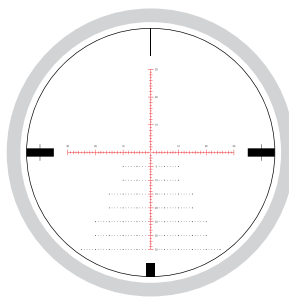

EBR-2B MOA/MRAD
GLASS-ETCHED ILLUMINATED
The EBR-2B is a first focal plane ranging reticle using MOA or MRAD-based subtension lines for ranging, holdover, and windage corrections. A windage tree in the lower two quadrants offers quick windage corrections and holdovers at distance.

Razor® HD p. 29

RETICLES

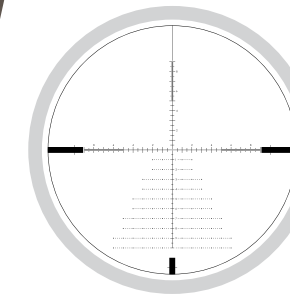

EBR-2C MOA/MRAD
GLASS-ETCHED
Combining the utility of a hashmark reticle for ranging and holdovers with the fast, easy windage corrections of a windage tree, the first focal plane EBR-2C fits right in with long-range precision and competition shooters.

Diamondback® Tactical p. 43

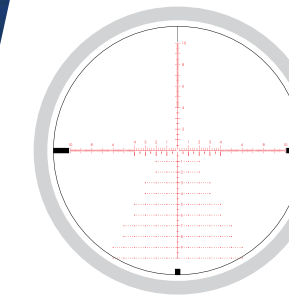

EBR-7B MOA/MRAD
GLASS-ETCHED ILLUMINATED
Packed with useful subtension data for long-range competition shooting or hunting, the EBR-7B is a hashmarked ranging reticle available in first focal plane. A windage tree in the lower two quadrants is perfect for fast follow-up corrections for both wind and elevation.

Razor® HD AMG® p. 21

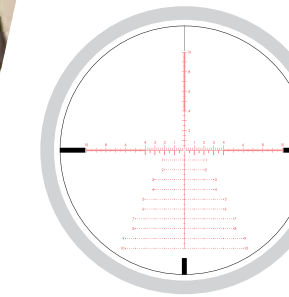

EBR-7C MOA/MRAD
GLASS-ETCHED ILLUMINATED
Packed with useful subtension data for long-range competition shooting or hunting, the EBR-7C is a hashmarked ranging reticle available in first focal plane. 0.2 MRAD hashmarks provide ultra-precise measurements, and a windage tree in the lower stadia have moved to the outside of the windage dots for less obstruction around the vertical stadia itself.

Razor® HD Gen II p. 25

Viper® PST™ Gen II p. 33

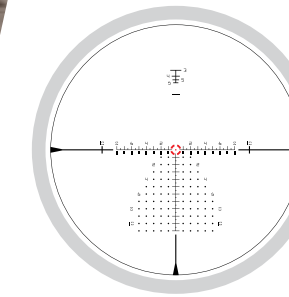

EBR-9 MRAD
GLASS-ETCHED ILLUMINATED
Designed for use in close-quarters and long range shooting, the EBR-9 reticle can be used to effectively determine ranges, holdovers, and windage corrections.

Razor® HD Gen III p. 23

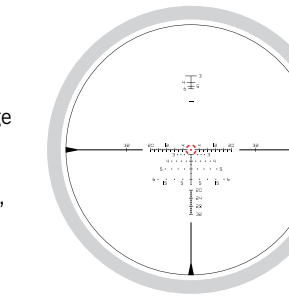

EBR-9 BDC MOA
GLASS-ETCHED ILLUMINATED
Designed for use in close-quarters and long range shooting, the EBR-9 reticle adds Bullet Drop Compensation for accurate shots on targets of known distance.

Razor® HD Gen III p. 23

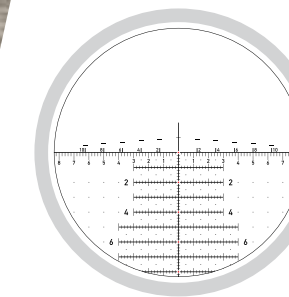

HORUS™ H59™ MRAD
GLASS-ETCHED ILLUMINATED
An MRAD-based reticle with an incredible variety of accommodations for bullet-drop, wind corrections, spotting, and ranging. Designed for long-range precision shooters.

Razor® HD Gen II p. 25

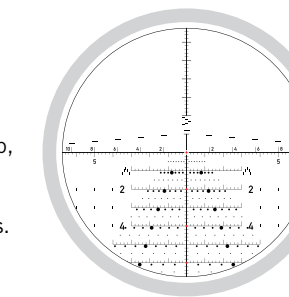

HORUS™ TREMOR3™ MRAD
GLASS-ETCHED ILLUMINATED
An MRAD based reticle built for long-range precision and even faster transitions, this reticle gets you all the accommodations you need for bullet-drop, wind corrections, spotting, and ranging.

Razor® HD Gen II p. 25

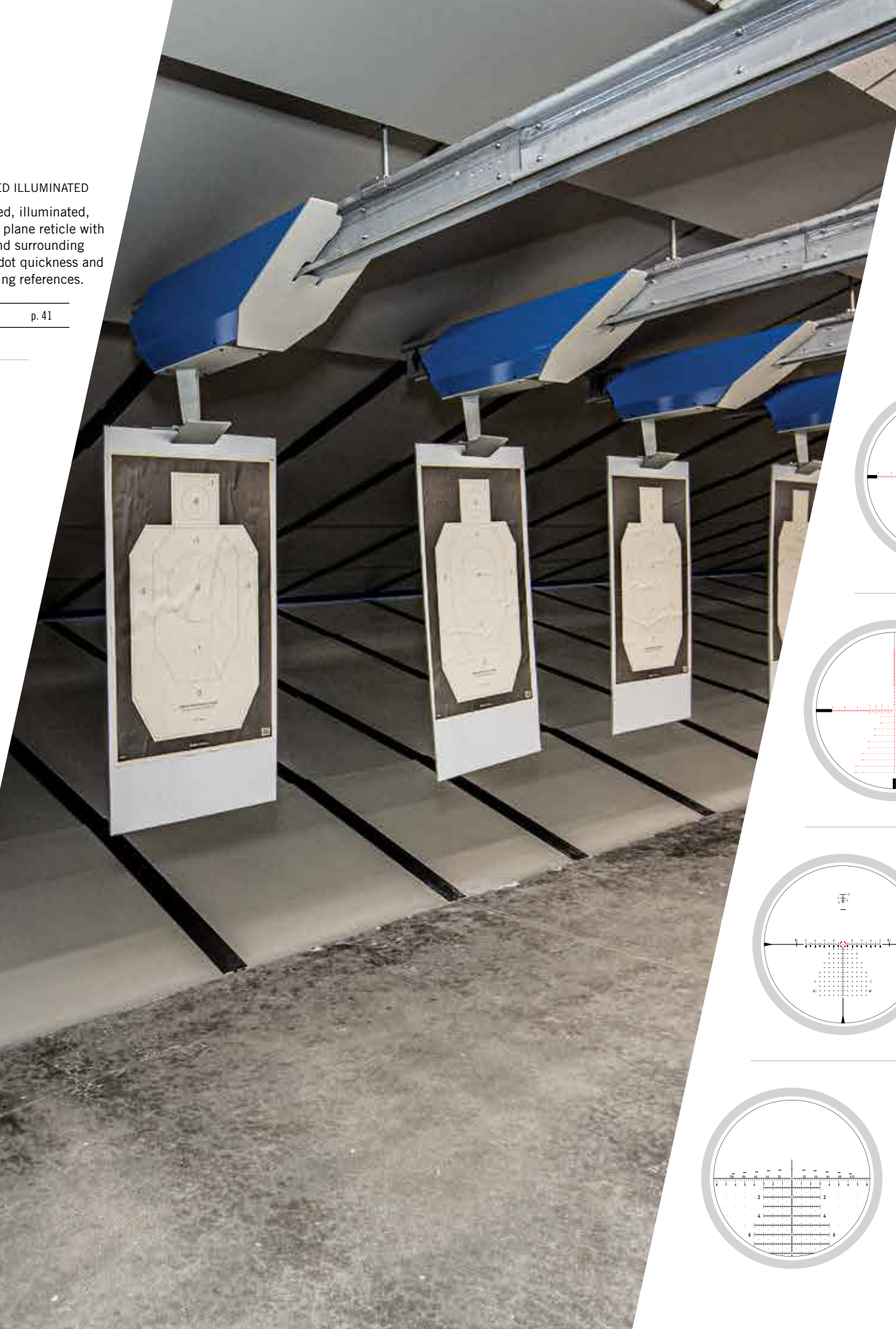



EPISODE 1:
RELOADING TO THE EXTREME

PODVENTURES



EPISODE 2:
BOATS N' BOWS



EPISODE 3:
CRUISIN' FOR COUES



PODVENTURES

You've heard the full-length episodes ... You've tuned in for #10MinuteTalks ... Now get yourself ready for an all-encompassing, fully-in-depth, special feature experience with #Podventures!



What's a Podventure? The story of a hunt, competition, or anything else hunting, shooting, or food-related, told over the series of multiple episodes, diving into nearly every single detail of the experience from start to finish. Each adventure will have its own unique twist, most likely putting Jimmy and Mark completely out of their comfort zone for your learning and entertainment pleasure.

When these special episodes release, the entire series will be published over the course of just a week, making for a truly binge-worthy listening experience. As always, supporting video content will be shot and posted on our Vortex Nation® Podcast Youtube channel as well!

YOU CAN ALSO CONNECT WITH US ON



YOU ARE VORTEX NATION

COUNTLESS STORIES. ONE VORTEX NATION®.

That moment of quiet and clarity, time seeming to stop, as you settle your sights on a bull elk and begin to squeeze the trigger.

The adrenaline hitting your blood as the range officer calls, "Shooter ready?" and your pulse hammers in your ears.

Or maybe it's simpler and closer to home. Pulling your father's old gun from its case to teach your kids to pop cans the way he taught you. The security of knowing you can carry the means to protect yourself and your family from those who'd do you harm.

We all have different stories about how shooting and the outdoors became a part of our lives. But together, we seek out this lifestyle because it sustains us and connects us with our family, our friends, and our history.

Together, your stories inspire us to innovate, to push ourselves to create the tools you need to have the type of hunt that's worth retelling over the fire back at camp, and the kind of shoot your friends will talk about for years.

Thank you Vortex Nation®.



VORTEX[®]



2020 CATALOG