



VORTEX®

2022 CATALOG



TABLE OF CONTENTS



VORTEXOPTICS.COM

# TABLE OF CONTENTS

## RIFLESCOPES

- 25 Razor® HD Gen III
- 26 Razor® HD Gen II
- 27 Razor® HD Gen II-E
- 29 Razor® HD LHT™
- 31 Golden Eagle® HD
- 33 Viper® PST™ Gen II
- 34 Viper® HST™
- 35 Viper® / HSLR™ / HS™
- 37 Strike Eagle®
- 39 Venom®
- 40 Diamondback® Tactical
- 41 Diamondback®
- 42 Crossfire® II 30mm
- 43 Crossfire® II 1 inch
- 44 Riflelescope Accessories

## RED DOTS

- 61 AMG® UH-1® Gen II
- 63 SPARC® SOLAR
- 65 SPARC® AR
- 66 Strikefire® II
- 67 Crossfire®
- 68 Razor®
- 69 Viper®
- 69 Venom®
- 70 Spitfire™ HD Gen II
- 71 Spitfire™ AR
- 72 Red Dot Accessories

## BINOCULARS

- 79 Razor® UHD
- 81 Razor® HD
- 83 Kaibab® HD
- 85 Viper® HD
- 86 Diamondback® HD
- 87 Crossfire® HD
- 88 Raptor™
- 89 Vanquish®
- 90 Binocular Accessories

## RANGEFINDERS

- 96 Fury® HD 5000 AB
- 97 Fury® HD 5000
- 99 Razor® HD 4000
- 100 Ranger® 1800
- 101 Impact® 1000

## MONOCULARS

- 108 Recon® R/T
- 109 RECCE Pro® HD
- 110 Solo® R/T
- 111 Solo®

## SPOTTING SCOPES

- 117 Razor® HD
- 119 Viper® HD
- 121 Diamondback® HD

## TRIPODS

- 126 Radian™ Carbon
- 127 Ridgeview™ Carbon
- 128 Summit™ Carbon II
- 129 High Country™ II

## INFORMATION

- 46 Reticles
- 130 Features Descriptions
- 131 Riflelescope Dimensions
- 132 Product Specs

## EXTRA STUFF

- 8 New for 2022
- 12 Vortex® Wear
- 16 Vortex Edge®
- 22 How to Choose Your Riflelescope
- 50 Staff Picks
- 74 Thank You Veterans
- 76 How to Choose Your Binocular
- 92 Tips from the Pros
- 104 Vortex Optics YouTube
- 112 Vortex Nation™ Podcast
- 122 Public Lands
- 140 Cheers to You Vortex Nation™



VORTEX NATION™



VORTEXOPTICS.COM



*HERE FOR YOU.*

# VORTEX NATION™

We live in a time of truly endless possibilities. Each day there are new ways of doing familiar things, and completely new opportunities begging us to jump in for the first time. The thrill of adventure and continual self-improvement is unquenchable – What’s over that next hill? How far can you stretch your effective range? What training do you need to stay one step ahead of your quarry, your competition, or potential threats to your loved ones or your community?

Regardless of who you are, what you’ve done, or what you’ll accomplish, you know these pursuits are best done with an experienced guide in your corner throughout the whole journey. Conveniently, there’s one just a phone call, e-mail, message, podcast, or firearms training class away here at Vortex®, with folks whose undying passion is to provide the products, knowledge, and helping hand you need to find your path to success and charge confidently onward.

**These are your adventures. We’re honored to be part of them.**



VIP WARRANTY

A top-down view of two rifle scopes on a rusty metal surface. On the left is a heavily rusted, old scope. On the right is a modern, sleek black Vortex scope. Several brass bullet casing are scattered around the scopes. The word 'NO' is written in large, white, outlined letters, and 'QUESTIONS ASKED.' is written in large, white, solid letters below it.

# NO QUESTIONS ASKED.

**COVERED.**

**UNLIMITED. UNCONDITIONAL. LIFETIME WARRANTY.**



## OUR VIP WARRANTY IS ABOUT YOU, NOT US.

VIP stands for a Very Important Promise to you, our customer. We will repair or replace your Vortex® product in the event it becomes damaged or defective — at no charge to you. If we cannot repair your product, we will replace it with a product in perfect working order of equal or better physical condition.

It doesn't matter how it happened, whose fault it was, or where you purchased it: The VIP Warranty is fully transferable, no receipt needed. If you ever have a problem, no matter the cause, we promise to take care of you. You can count on the VIP Warranty for all Vortex Optics riflescopes, prism scopes, red dots, rangefinders, binoculars, spotting scopes, tripods, monoculars, gear, and apparel.

**VortexOptics.com • 1-800-4-VORTEX**  
**One Vortex Drive, Barneveld, Wisconsin 53507**

Vortex® will repair or replace the product. Absolutely free—no matter the cause.  
Does not cover loss, theft, deliberate damage, or cosmetic damage that does not hinder the performance of the product.



**NEW** FOR  
**2022**

**RAZOR<sup>®</sup> HD GEN III**  
6-36x56 FFP RIFLESCOPE



**NOBODY EVER SAID**



A close-up photograph of a soldier in full combat gear, including a helmet with various attachments and a tactical vest. The soldier is aiming a rifle equipped with a large, high-magnification scope. The background is slightly blurred, showing another soldier in the distance. The image is overlaid with a teal graphic element in the top left and bottom right corners.

**YOU HAD TO FIGHT FAIR.**

**LEARN MORE**

SEE PAGE 25 OR VISIT [VORTEXOPTICS.COM](http://VORTEXOPTICS.COM)



TAKE YOUR RED DOT  
6X FARTHER.

NEW FOR 2022



**LEARN MORE**  
SEE PAGE 72 OR VISIT [VORTEXOPTICS.COM](http://VORTEXOPTICS.COM)

VORTEXOPTICS.COM

**NEW** FOR

**2022**

# MICRO6X

MAGNIFIER





VORTEX® WEAR

DESIGNED FOR  
**EVERY DAY**

BUILT FOR  
**ADVENTURE**

Men's Trail Call Tech Flannel (Blue Grey)  
Force on Force Cap (Brown)



Women's Arctic Snap Pullover (Port)

VORTEX® WEAR

VORTEXOPTICS.COM

Women's Front Country Thermal (Charcoal)  
Front and Center Cap (Loden)



Men's Front Country Thermal (Olive)  
Camo Punch Cap (Black)



Men's Three Peaks Performance Hoodie (Black)  
Red Alert Cap (Loden)

Men's Center Ring T-Shirt (Grey Heather)  
Men's Sun Slayer' Shorts (Morel)  
Force on Force Cap (Black)



Women's Shed Hunter™ Pro Jacket (Black)





VORTEX® WEAR

Men's Callsign Long Sleeve Shirt (Black)  
Force on Force Cap (Multicam Camo)

Men's Trail Call Tech Flannel (Shadow)  
Red Alert Cap (Loden)

VORTEX® WEAR



# FIT FOR EVERYWHERE

Hunting, shooting, or just enjoying nature, you live for the outdoors.

Vortex® Wear is the perfect combination of technical features and total comfort, giving adventure-seekers like you more reasons to stay outside longer.



VORTEXOPTICS.COM

Outland Pursuit Hunting Vest (Blaze)  
Traditions Cap (Blaze)



Men's SunSlayer™ Hoodie (Turbulence)  
Red Alert Cap (Charcoal)



Men's FrontierLimits™ QuarterZip Hoodie (Black)  
Go Big Patch Cap (Blue Grey)



Men's Timber Rush™ Flannel (Burgundy)  
Full Tine Cap (Charcoal)  
Women's Timber Rush™ Flannel (Mayfly)  
Red Alert Cap (Charcoal)





# VORTEX EDGE

## TAILORED TRAINING EXPERIENCES FOR EVERY SHOOTER

We've said it before, and we'll say it again, fire arms training is not one-size-fits-all. Which is why we've crafted Vortex Edge®. First came the 55,000 sq. ft. indoor shooting facility, then came Vortex Edge®, a one-of-a-kind experience that offers personalized training programs designed for all levels of shooters and every shooting interest.

Whether you've recently purchased your first firearm or you have years of shooting knowledge, we invite you to visit us deep in the heart of the heartland, Barneveld, WI.

### INTRO CLASSES

No experience required.

- Intro to Pistol
- Intro to Carbine (AR-15)
- Intro to Long-Range

### TOTAL SHOOTER PROGRAM

Take your shooting fundamentals to the next level.

- Pistol Pipeline**  
Pistol 1→Pistol 2→Pistol 3
- Carbine Pipeline**  
Carbine 1→Carbine 2→Carbine 3
- Long-Range Pipeline**  
Long-Range 1→Long-Range 2→Long-Range 3

### SPECIALTY CLASSES

Apply your skills to real-world applications.

- Home Defense
- Hunter Marksmanship
- Everyday Ready
- CQB (Close-Quarters Battle)
- Intro to USPSA Competition
- Night-Vision





# INTRO CLASSES

## START YOUR SHOOTING JOURNEY WITH US

Whether your ultimate interest is to learn to safely handle a firearm, to gain insight into competing in action shooting sports, or to better understand the use of firearms as a tool in hunting or self-defense, your journey should begin at Vortex Edge®. Our dedicated and passionate instructors will set you on the path to success through one-on-one, hands-on teaching.

Unique to the Intro Classes at Vortex Edge®, we'll provide students with everything they may need for the class including the firearm, ammo, and any necessary accessories, absolutely free. We aim to provide a friendly and informative setting so students can gain familiarity with firearms, equipment, and the fundamentals of shooting.



VORTEX EDGE®



# total shooter PROGRAM

## **A TRAINING EXPERIENCE BUILT TO HELP YOU EXCEED YOUR GOALS**

For shooters who find themselves just beyond intro-level, this is your chance to get some of the most all-encompassing, personalized firearm training available anywhere and truly take your shooting to the next level. Building better shooters is what we do at Vortex Edge®, and that's exactly the focus of our Total Shooter Program. Fundamentally sound shooters can effectively apply their skills to any application they may find themselves in beyond the training environment. Each firearm discipline within the Total Shooter Program has its own 3-day "pipeline" which can be taken all at once, or in steps over time depending on your preference or schedule. Come ready to learn, shoot, and have a ton of fun!

# VORTEX

# EDGE®

VORTEXOPTICS.COM

## PRACTICAL TRAINING BEYOND JUST MARKSMANSHIP

Whether your goal is to confidently carry your concealed weapon or harvest small or big game, we have a specialty program for you. Our specialty classes at Vortex Edge® are designed for shooters who already have a foundational grasp on marksmanship and firearm handling who want to hone their skills further. So, visit us and learn how to shoot competition USPSA, defeat the dark in our Night-Vision class, or trudge with us through the woods in our Hunter Marksmanship course.

# specialty CLASSES



SCAN THE CODE TO LEARN MORE



CONNECT ON SOCIAL @VORTEXEDGE



FIND  
YOUR  
EDGE.



# riflescopes



# RIFLESCOPES

## COMPARISON CHART



	RAZOR® HD GEN III	RAZOR® HD GEN II	RAZOR® HD GEN II-E	RAZOR® HD LHT™	GOLDEN EAGLE® HD	VIPER® PST™ GEN II	VIPER® HST™	VIPER® HSLR™
<b>Intended Use</b>	Precision Long-Range, Competition, Mil/LE	Precision Long-Range, Competition, Mil/LE	Competition, Mil/LE	Western Hunting	F-Class/Bench Rest	Precision Long-Range, Competition, Recreational	Precision Long-Range, Recreational	Western Hunting
<b>Configurations</b>	6-36x56, 1-10x24	4.5-27x56	1-6x24	4.5-22x50, 3-15x50, 3-15x42	15-60x52	5-25x50, 3-15x44, 2-10x32, 1-6x24	6-24x50, 4-16x44	6-24x50, 4-16x50
<b>Focal Plane Options</b>	FFP	FFP	SFP	FFP, SFP	SFP	FFP, SFP	SFP	FFP, SFP
<b>Tube Size Options</b>	34mm	34mm	30mm	30mm	30mm	30mm	30mm	30mm
<b>Turret Styles</b>	Locking Exposed, Capped (1-10x Model)	Locking Exposed	Capped	Locking Exposed Elevation, Capped Windage	Exposed	Exposed, Capped	Exposed	Exposed Elevation, Capped Windage
<b>Zero Stop</b>	L-Tec™	L-Tec™	N/A	RevStop®	N/A	RZR™	CRS™	CRS™
<b>Illumination</b>	Yes	Yes	Yes	Yes	No	Yes	No	No
<b>Reticles</b>	EBR-7D (MOA/MRAD) EBR-9 (MOA/MRAD)	EBR-7C (MOA/MRAD) Horus™ H59™ (MRAD) Horus™ Tremor3™ (MRAD)	VMR-2 (MOA/MRAD) JM-BDC (MOA)	XLR-2 (MOA/MRAD) G4i BDC (MRAD) HSR-5i (MOA/MRAD)	ECR-1 (MOA) SCR-1 (MOA)	EBR-7C (MOA/MRAD) EBR-4 (MOA) VMR-2 (MOA/MRAD)	VMR-1 (MOA/MRAD)	XLR (MOA) Dead-Hold® BDC (MOA)



	VIPER® HS™	VIPER®	STRIKE EAGLE®	VENOM®	DIAMONDBACK® TACTICAL	DIAMONDBACK®	CROSSFIRE®
<b>Intended Use</b>	Western Hunting, Midwestern Hunting	Varmint Hunting, Recreational	Competition, Recreational	Long-Range, Recreational	Long-Range, Recreational	Eastern Hunting, Midwestern Hunting	Eastern Hunting, Midwestern Hunting
<b>Configurations</b>	4-16x50, 4-16x44, 2.5-10x44	6.5-20x50	5-25x56, 1-8x24, 1-6x24	5-25x56	6-24x50, 4-16x44, 4-12x40	4-12x40, 3.5-10x50, 3-9x40, 2-7x35, 1.75-5x32	6-24x50, 6-18x44, 4-16x50, 4-12x44, 4-12x40, 3-12x56, 3-9x50, 3-9x40, 2-7x32, 1-4x24
<b>Focal Plane Options</b>	SFP	SFP	FFP, SFP	FFP	FFP, SFP	SFP	SFP
<b>Tube Size Options</b>	30mm	30mm	34mm, 30mm	34mm	30mm, 1"	1"	30mm, 1"
<b>Turret Styles</b>	Capped	Capped	Locking Exposed, Capped (1-6x & 1-8x Models)	Exposed	Exposed	Capped	Capped
<b>Zero Stop</b>	N/A	N/A	RevStop®	RevStop®	N/A	N/A	N/A
<b>Illumination</b>	No	No	Yes	No	No	No	Select Models
<b>Reticles</b>	Dead-Hold® BDC (MOA)	Dead-Hold® BDC (MOA) Mil Dot (MOA)	EBR-7C (MOA/MRAD) AR-BDC3 (MOA)	EBR-7C (MOA/MRAD)	EBR-2C (MOA/MRAD) VMR-1 (MOA)	Dead-Hold® BDC (MOA) V-Plex (MOA)	Dead-Hold® BDC (MOA) V-Brite® (MOA), V-Plex (MOA) Straight-Wall BDC (MOA) XBR®-2 (MOA)

# HOW TO CHOOSE YOUR RIFLESCOPE

«« PICK YOUR APPLICATION »»»



## WESTERN HUNTING

Majestic mountain tops, wide open plains, and severe weather challenge Western hunters to not just place long-range shots, but to place them consistently and under stress.

3-15x  
4-16x  
6-24x

### MAGNIFICATION/CONFIGURATION

With more open spaces comes more need for a high-power optic, but that doesn't mean you have to give up a solid field of view. Popular magnification ranges would include 3-15x, 4-16x, and 6-24x.



### TURRETS

A Western hunter is more likely to encounter long-range shots and may want a more feature-rich turret. Exposed elevation turrets allow rapid adjustments, and a locking turret means you can keep those adjustments in place. Zero stops give you a reliable return to your original zero after dialing.

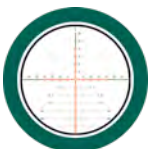

### RETICLE

To enable accurate shot placement at longer distances, Western hunters can benefit from more robust reticle systems. Common reticle tools allow hunters to effectively determine ranges, holdovers, windage corrections, and moving target leads. Illuminated reticles ensure a clear point of aim in low light, when big game is often on the move. Finally, utilizing a First Focal Plane reticle for longer range hunting means that the reticle subtensions are accurate throughout the magnification range.

### OUR SCOPE RECOMMENDATIONS:

GOOD: Viper® HS™ 4-16x44, 4-16x50

BETTER: Viper® HSLR™ 4-16x50, 6-24x50 FFP

BEST: Razor® HD LHT™ 3-15x42/50, 4.5-22x50 FFP



## MIDWESTERN & EASTERN HUNTING

From thick forests to mountains, heavy snow to driving rain, Midwestern and Eastern hunters see it all, and need a riflescope that can cover near and far shots while standing up to the elements.

2.5-10x  
3-9x  
4-12x  
4-16x

### MAGNIFICATION/CONFIGURATION

Midwestern and Eastern hunting riflescopes will be lower in magnification, taking advantage of a wider field of view and usually better low-light performance than higher magnification models. Popular magnification ranges include 2.5-10x, 3-9x, 4-12x, or 4-16x.



### TURRETS

Midwestern and Eastern hunters prefer capped turrets to keep adjustments protected from bumps or snags in the field.

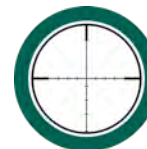

### RETICLE

Reticles designed for Midwestern and Eastern hunting are carefully designed to be as simple as possible. The classic Second Focal Plane (MOA) duplex crosshair reticle is still perfectly relevant, and BDC reticles take that same idea, but add in a few hashmarks for easy holdovers at further distances with modern calibers.

### OUR SCOPE RECOMMENDATIONS:

GOOD: Crossfire® II 3-9x40, 4-12x40

BETTER: Diamondback® 3-9x40, 4-12x40

BEST: Viper® HS™ 2.5-10x44

# HOW TO CHOOSE YOUR RIFLESCOPE

«« PICK YOUR APPLICATION »»»



## PRECISION SHOOTING

Precision rifle shooting is experiencing tremendous growth, thanks to dynamic shooting environments that demand consistency and test your skills. To extend your range and shoot more accurately, you'll need an optic that blends precision and a rugged build.

3-15x  
5-25x  
6-36x

### MAGNIFICATION/CONFIGURATION

A magnification range appropriate for small targets at both medium and long-range is necessary. Being able to rapidly acquire targets is important when time is of the essence, and a large field of view aids the shooter in locating targets quickly and efficiently. Having an optic with a wide range of magnification and large field of view are both features paramount to success.

### TURRETS

With all the bumps and movement associated with an intense course of fire, locking turrets can help ensure you don't dial by accident. Zero stops ensure you don't lose track of where you are within the overall travel range of your turret's system.

### RETICLE

A First Focal Plane reticle will give you an advantage, allowing you to utilize your reticle subtensions and visual features accurately throughout the magnification range. "Christmas tree" style reticles allow the user to hold for both elevation and wind corrections simultaneously and precisely. Other tools allow you to quickly estimate range, measure targets, calculate corrections, and even make shots on moving targets.

### OUR SCOPE RECOMMENDATIONS:

GOOD: Venom® 5-25x56 FFP

BETTER: Viper® PST™ Gen II 3-15x44, 5-25x50 FFP, Strike Eagle® 5-25x56 FFP

BEST: Razor® HD Gen III 6-36x56 FFP



## CLOSE-QUARTERS BATTLE

Look to an LPVO (Low Power Variable Optic) for fast work in tight quarters and versatility to go long. In CQB (Close-Quarters Battle) settings, a reliable point of aim up close is critical. An LPVO gives shooters the best of both worlds.

1-6x  
1-8x  
1-10x

### MAGNIFICATION/CONFIGURATION

If you plan on shooting close-quarters, an LPVO can deliver that true 1x experience, while still allowing you to go long. Most popular magnification options include 1-6x, 1-8x, and 1-10x.

### TURRETS

For recreational shooting, turrets are typically capped to protect your zero from accidental bumps and snags.

### RETICLE

Depending on when you shoot, an illuminated reticle can not only extend your shooting hours, but it can also provide a red-dot-like point of aim at low power, letting you make target transitions quickly. For longer-range shooting, reticles offering bullet drop and wind holds will make for more accurate shots without dialing your turrets. In general, look for a reticle that offers close-quarters features — such as an illuminated center dot — and features for ranging, holdovers, and windage corrections if you need them.

### OUR SCOPE RECOMMENDATIONS:

GOOD: Strike Eagle® 1-6x24, 1-8x24

BETTER: Viper® PST™ GEN II 1-6x24

BEST: Razor® HD GEN III 1-10x24



RAZOR® HD GEN III



everything  
IS IN RANGE.

VORTEXOPTICS.COM



# RAZOR<sup>®</sup> HD GEN III

## RIFLESCOPE

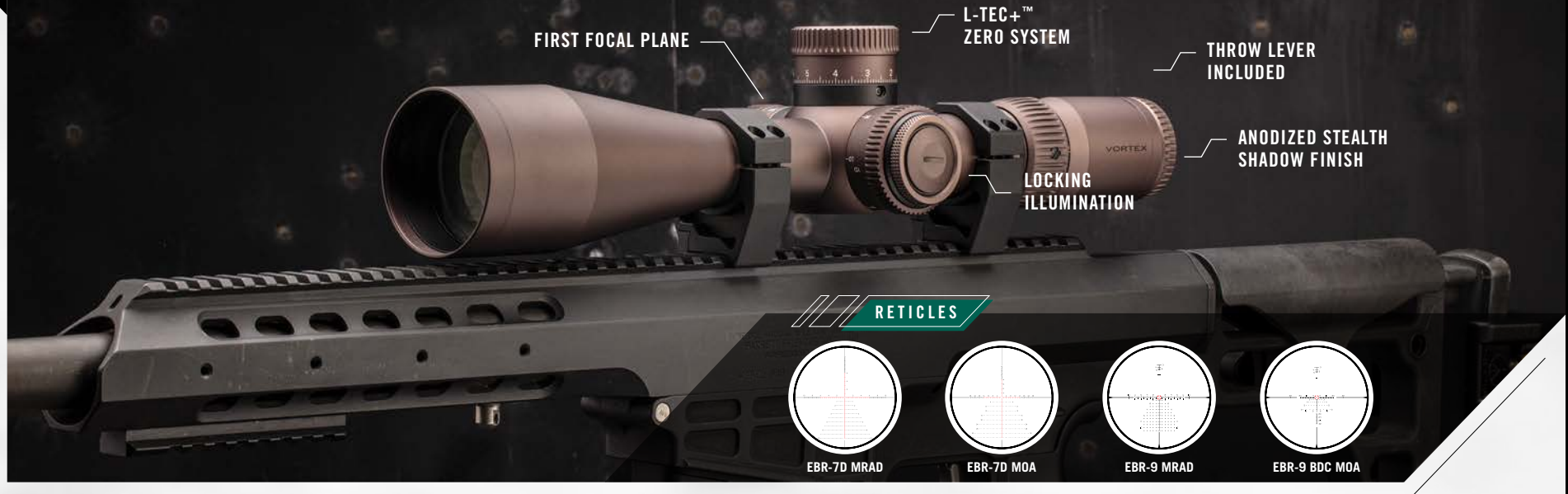

### EVERYTHING IS IN RANGE.

The intensity of tactical situations can push even the best shooters to their limits. When that intensity defines your shooting experience, the Razor<sup>®</sup> HD Gen III line up offers the precision tools you need to act quickly and decisively. Built around the perfect balance of magnification and field of view, you get an optical system with the resolution and contrast you need to clearly identify targets. The 1-10x24 offers a versatile magnification range, and a daylight bright illuminated reticle making this the perfect solution for close-quarters and mid to longer ranges. New this year, the 6-36x56 offers a precision long-range solution. Packed with features like the new EBR-7D Reticle designed to give the user a clean sight picture while also providing ample wind holds and ranging information, and the L-Tec+™ Zero Stop System, that allows for micro adjustments and an ultra-fast return to a rock solid zero. Sharing features like First Focal Plane reticles, locking illumination dials, and unmatched durability, the Razor<sup>®</sup> HD GEN III lineup is ready for duty.



1-10x24

6-36x56

SKU	MAGNIFICATION X OBJECTIVE LENS DIAMETER	FOCAL PLANE	RETICLE	ILLUMINATION	EYE RELIEF	LINEAR FIELD OF VIEW (@ 100 YARDS)	ZERO STOP	TUBE SIZE	LENGTH	WEIGHT
<b>NEW</b> RZR-63602	6-36x56	FFP	EBR-7D MRAD	Yes	3.5"	21.3' - 3.5'	L-Tec+™	34mm	15.3"	45.1 oz.
<b>NEW</b> RZR-63601			EBR-7D MOA							
RZR-11002	1-10x24	FFP	EBR-9 MRAD	Yes	3.6"	116.0' - 11.7'	N/A	34mm	10.1"	21.5 oz.
RZR-11001			EBR-9 BDC MOA							

#### FEATURES

- ▶ HD OPTICAL SYSTEM
- ▶ ARGON GAS PURGED
- ▶ XR™ PLUS LENS COATINGS
- ▶ WATERPROOF
- ▶ APOCHROMATIC
- ▶ FOGPROOF
- ▶ ARMORTEK<sup>®</sup>
- ▶ SHOCKPROOF

For a description of each feature, see page 132. For detailed reticle information, see pages 46-49 or visit [vortexoptics.com](http://vortexoptics.com).





# RAZOR<sup>®</sup> HD GEN II

## RIFLESCOPE

RAZOR<sup>®</sup> HD GEN II / RAZOR<sup>®</sup> HD GEN II-E



### DEADLY SERIOUS SCOPES FOR DEADLY SERIOUS WORK.

Tactical and competitive shooters looking for the optimal combination of features and optical quality have a clear go-to. The Razor<sup>®</sup> HD Gen II provides long-range shooters the advanced features needed to perform at the highest level. Featuring locking turrets, and the L-Tec<sup>™</sup> zero stop, which allows the user to dial quickly while maintaining a rock-solid return to zero. A full suite of First Focal Plane reticles provides the user with consistent subtensions at any magnification range. And a stunning optical system that delivers elite levels of clarity, resolution, light transmission, and edge-to-edge sharpness, caps off this incredible riflescope.



4.5-27x56

SKU	MAGNIFICATION X OBJECTIVE LENS DIAMETER	FOCAL PLANE	RETICLE	ILLUMINATION	EYE RELIEF	LINEAR FIELD OF VIEW (@ 100 YARDS)	ZERO STOP	TUBE SIZE	LENGTH	WEIGHT
RZR-42709	4.5-27x56	FFP	Horus <sup>™</sup> H59 <sup>™</sup> MRAD	Yes	3.7"	25.3' - 4.4'	L-Tec <sup>™</sup>	34mm	14.4"	48.5 oz.
RZR-42710			Horus <sup>™</sup> Tremor3 <sup>™</sup> MRAD							
RZR-42708			EBR-7C MRAD							
RZR-42707			EBR-7C MOA							

### FEATURES

- ▶ HD OPTICAL SYSTEM
- ▶ ARGON GAS PURGED
- ▶ XR<sup>™</sup> PLUS LENS COATINGS
- ▶ WATERPROOF
- ▶ APOCHROMATIC
- ▶ FOGPROOF
- ▶ ARMORTEK<sup>®</sup>
- ▶ SHOCKPROOF

For a description of each feature, see page 132. For detailed reticle information, see pages 46-49 or visit [vortexoptics.com](http://vortexoptics.com).



# RAZOR<sup>®</sup> HD GEN II-E

RIFLESCOPE



\*Center dot illumination.



1-6x24

## THE 'E' IS SILENT.

Perfect for the AR platform, the Razor<sup>®</sup> HD Gen II-E is the top-tier optical solution for short to medium-range engagements. Among the lightest in its class, the “E” (Enhanced) model allows for quicker target transitions and less fatigue during long-range days. It delivers a stunning level of clarity, resolution, color accuracy, light transmission, and edge-to-edge sharpness. True 1x is complimented by an ultra-forgiving eyepiece with generous eye relief for a HUD-like sight picture. The daylight bright illuminated center dot facilitates close-quarters target acquisition. Built like a tank on a 30mm aircraft-grade aluminum tube, the Razor<sup>®</sup> HD Gen II-E features low profile capped windage and elevation turrets for streamlined performance.

SKU	MAGNIFICATION X OBJECTIVE LENS DIAMETER	FOCAL PLANE	RETICLE	ILLUMINATION	EYE RELIEF	LINEAR FIELD OF VIEW (@ 100 YARDS)	ZERO STOP	TUBE SIZE	LENGTH	WEIGHT
RZR-16009			VMR-2 MRAD							
RZR-16010	1-6x24	SFP	VMR-2 MOA	Yes	4.0"	115.2' - 20.5'	N/A	30mm	10.1"	21.5 oz.
RZR-16008			JM-1 BDC MOA							

### FEATURES

- ▶ HD OPTICAL SYSTEM
- ▶ ARGON GAS PURGED
- ▶ XR™ PLUS LENS COATINGS
- ▶ WATERPROOF
- ▶ APOCHROMATIC
- ▶ FOGPROOF
- ▶ ARMORTEK<sup>®</sup>
- ▶ SHOCKPROOF

For a description of each feature, see page 132. For detailed reticle information, see pages 46-49 or visit [vortexoptics.com](http://vortexoptics.com).





RAZOR® HD LHT™



**BUILT FOR LONG  
RANGE AND THE  
long haul.**

VORTEXOPTICS.COM

# RAZOR® HD LHT™

RIFLESCOPE

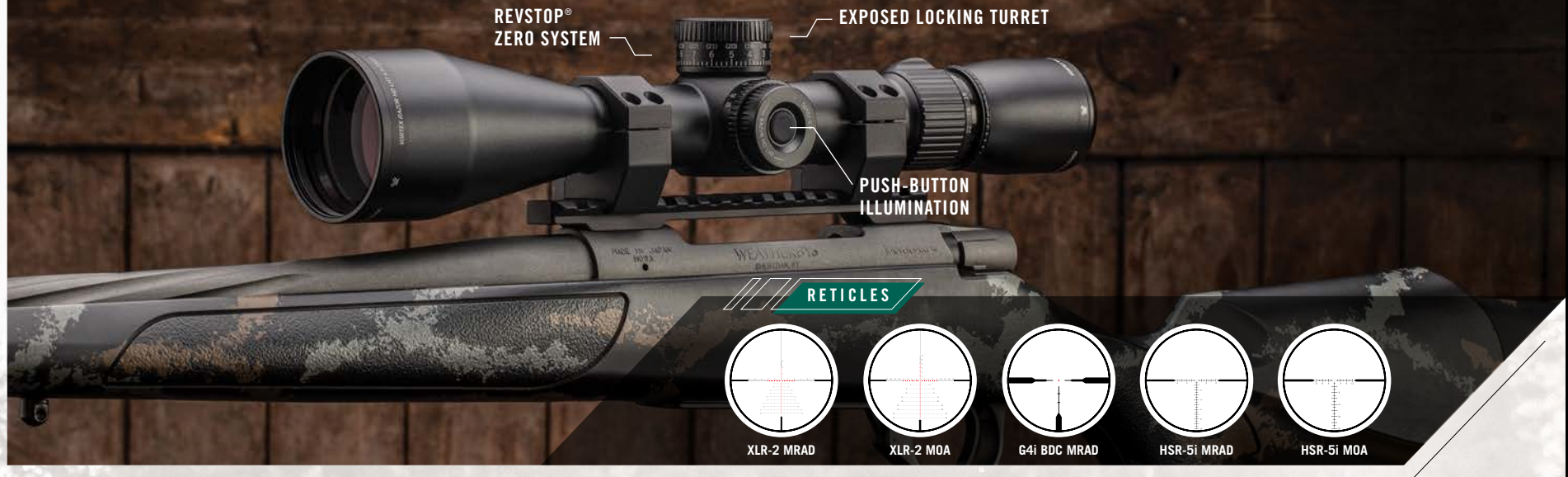

## BUILT FOR LONG RANGE AND THE LONG HAUL.

From open-country mule deer to stalking rams in the mountains, the Razor® HD LHT™ is the one long-range hunting optic you need to fill those faraway tags. We've stripped away everything you don't need to create a riflescope that's among the lightest in its class, combining stunning HD clarity with tack-sharp resolution to create an optical system that's as clear at first light as it is at high noon. You also get push-button illumination on a reticle that's already intuitive and easy to use. What really pushes the Razor® HD LHT™ into "must-have" territory are the locking elevation turret, and our exclusive RevStop® Zero System, which gives you a rock-solid return to zero so you can dial as much as you need to. Extend your effective range with the Razor® HD LHT™.



SKU	MAGNIFICATION X OBJECTIVE LENS DIAMETER	FOCAL PLANE	RETICLE	ILLUMINATION	EYE RELIEF	LINEAR FIELD OF VIEW (@ 100 YARDS)	ZERO STOP	TUBE SIZE	LENGTH	WEIGHT
<b>NEW</b> RZR-42202	4.5-22x50	FFP	XLR-2 MRAD	Yes	4.0"	23.5' - 4.7'	RevStop®	30mm	13.3"	21.7 oz.
<b>NEW</b> RZR-42201			XLR-2 MOA							
RZR-31503	3-15x50	SFP	G4i BDC MRAD	Yes	3.8"	35.3' - 7.0'	RevStop®	30mm	13.6"	20.5 oz.
RZR-31502	3-15x42	SFP	HSR-5i MRAD	Yes	3.8"	35.3' - 7.0'	RevStop®	30mm	13.4"	19.1 oz.
RZR-31501			HSR-5i MOA							

### FEATURES

- ▶ HD OPTICAL SYSTEM
- ▶ XR™ PLUS LENS COATINGS
- ▶ APOCHROMATIC
- ▶ ARMORTEK®
- ▶ ARGON GAS PURGED
- ▶ WATERPROOF
- ▶ FOGPROOF
- ▶ SHOCKPROOF

For a description of each feature, see page 132. For detailed reticle information, see pages 46-49 or visit vortexoptics.com.





GOLDEN EAGLE® HD



redefine  
YOUR EFFECTIVE RANGE.

VORTEXOPTICS.COM

# GOLDEN EAGLE® HD

RIFLESCOPE



## REDEFINE YOUR EFFECTIVE RANGE.

Specifically designed for F-Class and Bench Rest competition shooters, the Golden Eagle® HD is the winning edge you need. The 15-60x magnification range, ultra-precise 1/8 MOA adjustments, and extremely fine second focal plane reticle options help maximize precision on known-distance, long-range targets. All these features are complimented by an optical system that provides a super-sharp target picture and the ability to read mirage and other wind indicators accurately. Equally impressive, the Golden Eagle® HD weighs in at 29.7 ounces, helping shooters adhere to strict competition weight limits. When you're going for gold, go for the Golden Eagle® HD.



15-60x52



### ASR (APERTURE STOP RING)

Broadens the depth of field allowing the shooter to more easily observe down-range mirage and other wind indicators while keeping the target in focus.



### WINDAGE TURRET

The 10 MOA windage turret allows dialing up to 10 MOA while not getting lost on the adjustment (the standard turret will allow up to 5 MOA).

SKU	MAGNIFICATION X OBJECTIVE LENS DIAMETER	FOCAL PLANE	RETICLE	ILLUMINATION	EYE RELIEF	LINEAR FIELD OF VIEW (@ 100 YARDS)	ZERO STOP	TUBE SIZE	LENGTH	WEIGHT
TCS-1503	15-60x52	SFP	ECR-1 MOA	No	3.9"	6.3' - 1.7'	N/A	30mm	16.1"	29.7 oz.
TCS-1501			SCR-1 MOA							

## FEATURES

- ▶ HD OPTICAL SYSTEM
- ▶ XR™ PLUS LENS COATINGS
- ▶ PLASMA TECH
- ▶ APOCHROMATIC
- ▶ ARMORTEK®
- ▶ ARGON GAS PURGED
- ▶ WATERPROOF
- ▶ FOGPROOF
- ▶ SHOCKPROOF

For a description of each feature, see page 132. For detailed reticle information, see pages 46-49 or visit [vortexoptics.com](http://vortexoptics.com).





VIPER® PST™ GEN II



WHEN ALL ELSE FAILS,  
this won't.

VORTEXOPTICS.COM



# VIPER® PST™ GEN II

RIFLESCOPE



\*Center dot illumination.

## WHEN ALL ELSE FAILS, THIS WON'T.

The Viper® PST™ Gen II brings you all the features of elite, top-tier tactical optics at a fraction of the cost. The optical system delivers bright, crisp images across the zoom range with an impressive field of view for quicker target acquisition. Whether you're topping your door kicker or dialing precision long-range shots, there's a Viper® PST™ Gen II to fulfill your needs and exceed your expectations.

SKU	MAGNIFICATION X OBJECTIVE LENS DIAMETER	FOCAL PLANE	RETICLE	ILLUMINATION	EYE RELIEF	LINEAR FIELD OF VIEW (@ 100 YARDS)	ZERO STOP	TUBE SIZE	LENGTH	WEIGHT
PST-5259	5-25x50	FFP	EBR-7C MRAD	Yes	3.4"	24.1' - 4.8'	RZR™	30mm	15.8"	31.2 oz.
PST-5256		SFP	EBR-7C MOA							
PST-5251		SFP	EBR-4 MOA							
PST-3159	3-15x44	FFP	EBR-7C MRAD	Yes	3.4"	41.2' - 8.6'	RZR™	30mm	14.3"	28.1 oz.
PST-3156		SFP	EBR-7C MOA							
PST-3151		SFP	EBR-4 MOA							
PST-2105	2-10x32	FFP	EBR-4 MRAD	Yes	3.2"	58.3' - 11.7'	RZR™	30mm	12.6"	26.3 oz.
PST-2101		SFP	EBR-4 MOA							
PST-1607	1-6x24	SFP	VMR-2 MRAD	Yes	3.8"	112.5' - 18.8'	N/A	30mm	10.8"	22.7 oz.
PST-1605		SFP	VMR-2 MOA							



### FEATURES

- ▶ XD™ OPTICAL SYSTEM
- ▶ XR™ LENS COATINGS
- ▶ ARMORTEK®
- ▶ ARGON GAS PURGED
- ▶ WATERPROOF
- ▶ FOGPROOF
- ▶ SHOCKPROOF

For a description of each feature, see page 132. For detailed reticle information, see pages 46-49 or visit vortexoptics.com.





# VIPER<sup>®</sup> HST<sup>™</sup>

RIFLESCOPE

CRS<sup>™</sup> ZERO STOP

EXPOSED TACTICAL-STYLE  
TURRETS



## RETICLES



VMR-1 MRAD



VMR-1 MOA

## ONE SCOPE THAT DOES IT ALL.

Tree stands to mountain tops, bolt guns to ARs, the Viper<sup>®</sup> HST<sup>™</sup> is at home wherever you are. Blending many of the best features from our incredibly popular Viper<sup>®</sup> PST<sup>™</sup> and Viper<sup>®</sup> HS<sup>™</sup> riflescopes, the Viper<sup>®</sup> HST<sup>™</sup> is built on an ultra-strong 30mm, one-piece aluminum tube to deliver ample windage and elevation travel. An advanced optical system, highlighted by a 4x zoom range, provides magnification versatility and a forgiving eyepiece with increased eye relief, getting shooters on target quickly. Incredibly precise, repeatable, and durable tactical turrets built for dialing — along with its hashmark-based VMR-1 reticle — top this rifle scope's complete long-range performance features.



4-16x44

6-24x50

## FEATURES

- ▶ XD<sup>™</sup> OPTICAL SYSTEM
- ▶ XR<sup>™</sup> LENS COATINGS
- ▶ ARMORTEK<sup>®</sup>
- ▶ ARGON GAS PURGED
- ▶ WATERPROOF
- ▶ FOGPROOF
- ▶ SHOCKPROOF

SKU	MAGNIFICATION X OBJECTIVE LENS DIAMETER	FOCAL PLANE	RETICLE	ILLUMINATION	EYE RELIEF	LINEAR FIELD OF VIEW (@ 100 YARDS)	ZERO STOP	TUBE SIZE	LENGTH	WEIGHT
VHS-4310	6-24x50	SFP	VMR-1 MRAD	No	4.0"	17.8' - 5.1'	CRS <sup>™</sup>	30mm	15.4"	22.6 oz.
VHS-4325			VMR-1 MOA							
VHS-4308	4-16x44	SFP	VMR-1 MRAD	No	4.0"	27.4' - 7.4'	CRS <sup>™</sup>	30mm	13.3"	20.8 oz.
VHS-4309			VMR-1 MOA							

For a description of each feature, see page 132. For detailed reticle information, see pages 46-49 or visit [vortexoptics.com](http://vortexoptics.com).



# VIPER® / HSLR™ / HS™

## RIFLESCOPE



### PROVEN IN THE ONLY LAB THAT MATTERS.

Ask us to pick one series of riflescopes as the go-to for just about any hunting or recreational shooting application and the answer is almost always the Viper®. Hunters and shooters looking for clear, crisp, and bright views with rock-steady performance would be hard-pressed to find a better rifle topper. Plus, you get all the options you need: Take fully-capped turrets, or choose the Viper® HSLR™, with its exposed elevation turret for quick dialing on long-range shots. Whether ringing steel at the range or filling the freezer, the Viper® series is always ready for action.



SKU	MAGNIFICATION X OBJECTIVE LENS DIAMETER	FOCAL PLANE	RETICLE	ILLUMINATION	EYE RELIEF	LINEAR FIELD OF VIEW (@ 100 YARDS)	ZERO STOP	TUBE SIZE	LENGTH	WEIGHT
<b>Viper® HSLR™</b>										
VHS-4315-LR	6-24x50	FFP	XLR MOA	No	4.0"	17.8' - 5.1'	CRS™	30mm	15.4"	21.8 oz.
VHS-4307-LR	4-16x50	SFP	Dead-Hold® BDC MOA	No	4.0"	27.4' - 7.4'	CRS™	30mm	13.6"	21.2 oz.
<b>Viper® HS™</b>										
VHS-4307	4-16x50	SFP	Dead-Hold® BDC MOA	No	4.0"	27.4' - 7.4'	N/A	30mm	13.6"	20.4 oz.
VHS-4305	4-16x44	SFP	Dead-Hold® BDC MOA	No	4.0"	27.4' - 7.4'	N/A	30mm	13.4"	19.2 oz.
VHS-4303	2.5-10x44	SFP	Dead-Hold® BDC MOA	No	4.0"	47.0' - 10.9'	N/A	30mm	12.0"	17.3 oz.
<b>Viper®</b>										
VPR-M-06BDC	6.5-20x50	SFP	Dead-Hold® BDC MOA	No	3.1"	17.4' - 6.2'	N/A	30mm	14.4"	21.6 oz.
VPR-M-06MD			Mil Dot MOA							

### FEATURES

- ▶ XD™ OPTICAL SYSTEM
- ▶ XR™ LENS COATINGS
- ▶ ARMORTEK®
- ▶ ARGON GAS PURGED
- ▶ WATERPROOF
- ▶ FOGPROOF
- ▶ SHOCKPROOF

For a description of each feature, see page 132. For detailed reticle information, see pages 46-49 or visit vortexoptics.com.





STRIKE EAGLE®



PREPARE FOR IMMEDIATE  
impact.

VORTEXOPTICS.COM

# STRIKE EAGLE®

RIFLESCOPE



## PREPARE FOR IMMEDIATE IMPACT.

Executing technical, short, and long-range shots requires a versatile riflescope with rock-solid quality. Strike Eagle® riflescopes boast powerful features in a trim, lightweight, durable package making them ideal for value-minded shooters, or those looking to get in the game without taking out a loan to do it. A true 1x on the low end adapts to a wide range of scenarios, letting shooters engage targets from point-blank to extended ranges. In any application, the Strike Eagle® ensures accurate, reliable, and repeatable performance — every time you squeeze the trigger.

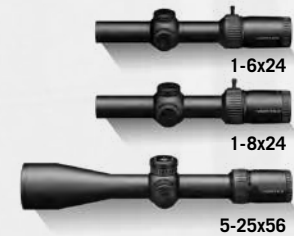

SKU	MAGNIFICATION X OBJECTIVE LENS DIAMETER	FOCAL PLANE	RETICLE	ILLUMINATION	EYE RELIEF	LINEAR FIELD OF VIEW (@ 100 YARDS)	ZERO STOP	TUBE SIZE	LENGTH	WEIGHT
SE-52504	5-25x56	FFP	EBR-7C MRAD	Yes	3.7"	24.0' - 5.2'	RevStop®	34mm	14.6"	30.4 oz.
SE-52503			EBR-7C MOA							
SE-1824-2	1-8x24	SFP	AR-BDC3 MOA	Yes	3.5"	109.0' - 14.4'	N/A	30mm	10.0"	17.4 oz.
SE-1624-2	1-6x24	SFP	AR-BDC3 MOA	Yes	3.5"	116.5' - 19.2'	N/A	30mm	10.5"	18.5 oz.

### FEATURES

- ▶ XD™ OPTICAL SYSTEM
- ▶ FULLY MULTI-COATED LENSES
- ▶ ARMORTEK®
- ▶ NITROGEN GAS PURGED
- ▶ WATERPROOF
- ▶ FOGPROOF
- ▶ SHOCKPROOF

For a description of each feature, see page 132. For detailed reticle information, see pages 46-49 or visit [vortexoptics.com](http://vortexoptics.com).





VENOM®



START LOOKING FOR A longer range.

VORTEXOPTICS.COM

# VENOM<sup>®</sup>

RIFLESCOPE



## START LOOKING FOR A LONGER RANGE.

Take the first step into long-range shooting with an optic that helps you go the distance with a ton of shooter-friendly features. Featuring a 5-25x mag range built into a 34mm tube for a massive amount of turret travel (85 MOA / 25 MRAD max elevation/windage), the Venom<sup>®</sup> also includes our RevStop<sup>®</sup> Zero System for a fast, easy, reliable return to zero. The First Focal Plane EBR-7C reticle gives you accurate holds at any magnification, and an included throw lever allows for fast transitions between magnifications. It's the quickest way to get your rifle out to 1,000 yards and beyond at a price that lets you go deep for less.

### FEATURES

- ▶ XD™ OPTICAL SYSTEM
- ▶ FULLY MULTI-COATED LENSES
- ▶ ARMORTEK<sup>®</sup>
- ▶ NITROGEN GAS PURGED
- ▶ WATERPROOF
- ▶ FOGPROOF
- ▶ SHOCKPROOF

SKU	MAGNIFICATION X OBJECTIVE LENS DIAMETER	FOCAL PLANE	RETICLE	ILLUMINATION	EYE RELIEF	LINEAR FIELD OF VIEW (@ 100 YARDS)	ZERO STOP	TUBE SIZE	LENGTH	WEIGHT
<b>NEW</b> VEN-52502	5-25x56	FFP	EBR-7C MRAD	No	3.6"	21.2' - 4.7'	RevStop <sup>®</sup>	34mm	15.3"	35.0 oz.
<b>NEW</b> VEN-52501			EBR-7C MOA							

For a description of each feature, see page 132. For detailed reticle information, see pages 46-49 or visit [vortexoptics.com](http://vortexoptics.com).



# DIAMONDBACK® TACTICAL

RIFLESCOPE

FIRST FOCAL PLANE  
MODELS AVAILABLE

EXPOSED TACTICAL  
TURRETS



## RETICLES



EBR-2C MRAD



EBR-2C MOA



VMR-1 MOA

## BEAT THE WIND, GRAVITY, AND YOUR PERSONAL BEST.

The Diamondback® Tactical puts the focus where it counts. Exposed turrets bring tracking performance previously unheard of at this price point, while its optical system delivers sharp image quality, even at long-range. Its simple design places you firmly in the driver's seat with the potential to take on 1,000 yards and beyond, and it's perfect for new shooters, your training rifle, or experienced shooters looking for a back-to-basics optic on their fun gun. Mount a first focal plane model on a sweet-shooting rifle and you got a competition rig without breaking the bank.



4-12x40



4-16x44



6-24x50

SKU	MAGNIFICATION X OBJECTIVE LENS DIAMETER	FOCAL PLANE	RETICLE	ILLUMINATION	EYE RELIEF	LINEAR FIELD OF VIEW (@ 100 YARDS)	ZERO STOP	TUBE SIZE	LENGTH	WEIGHT
DBK-10029	6-24x50	FFP	EBR-2C MRAD	No	3.9"	18.0' - 4.5'	N/A	30mm	14.3"	24.6 oz.
DBK-10028			EBR-2C MOA							
DBK-10027	4-16x44	FFP	EBR-2C MRAD	No	3.8"	26.9' - 6.7'	N/A	30mm	14.1"	23.1 oz.
DBK-10026			EBR-2C MOA							
DBK-10025	4-12x40	SFP	VMR-1 MOA	No	3.9"	23.6' - 7.9'	N/A	1"	14.1"	17.5 oz.

## FEATURES

- ▶ XD™ OPTICAL SYSTEM
- ▶ FULLY MULTI-COATED LENSES
- ▶ NITROGEN GAS PURGED
- ▶ WATERPROOF
- ▶ FOGPROOF
- ▶ SHOCKPROOF

For a description of each feature, see page 132. For detailed reticle information, see pages 46-49 or visit [vortexoptics.com](http://vortexoptics.com).





# DIAMONDBACK®

RIFLESCOPE



## GREATNESS RUNS IN THE FAMILY.

You know you love it — that “I-just-got-more-than-I-paid-for” feeling — and the price-to-performance ratio for the Diamondback® will put a big ol’ smile on your face. It’s a classic, with image quality, build quality, and overall feel that means you don’t have to settle for blah performance out of an affordable optic. A variety of configurations and a fast-focus eyepiece give you speed and versatility, and at this price, you can afford to spend more time in the woods.

SKU	MAGNIFICATION X OBJECTIVE LENS DIAMETER	FOCAL PLANE	RETICLE	ILLUMINATION	EYE RELIEF	LINEAR FIELD OF VIEW (@ 100 YARDS)	ZERO STOP	TUBE SIZE	LENGTH	WEIGHT
DBK-04-BDC	4-12x40	SFP	Dead-Hold® BDC MOA	No	3.1"	32.4' - 11.3'	N/A	1"	12.0"	14.2 oz.
DBK-03-BDC	3.5-10x50	SFP	Dead-Hold® BDC MOA	No	3.3"	35.8' - 13.5'	N/A	1"	12.5"	15.5 oz.
DBK-01-BDC	3-9x40	SFP	Dead-Hold® BDC MOA	No	3.3"	44.6' - 14.8'	N/A	1"	11.6"	14.5 oz.
DBK-M-01P			V-Plex MOA							
DBK-RIM	2-7x35 Rimfire	SFP	V-Plex MOA	No	3.1"	64.3' - 19.3'	N/A	1"	11.6"	13.7 oz.
DBK-08-BDC	1.75-5x32	SFP	Dead-Hold® BDC MOA	No	3.5"	68.3' - 23.1'	N/A	1"	10.2"	13.0 oz.



### FEATURES

- ▶ XD™ OPTICAL SYSTEM
- ▶ FULLY MULTI-COATED LENSES
- ▶ ARGON GAS PURGED
- ▶ WATERPROOF
- ▶ FOGPROOF
- ▶ SHOCKPROOF

For a description of each feature, see page 132. For detailed reticle information, see pages 46-49 or visit [vortexoptics.com](http://vortexoptics.com).





# CROSSFIRE® II

30MM TUBE RIFLESCOPE



## READY, AIM, DINNER!

With a scope offering as much variety as the Crossfire® II, you get options, options, and more options to match your needs. A 30mm tube diameter and incredibly versatile, top-end magnification makes this scope the perfect choice for an endless list of rifle-topping tasks. Exceptionally clear, fully multi-coated optics and superior build quality at this price will leave you scratching your head. It's everything you'd expect from the Crossfire®, and purpose-built for your needs.

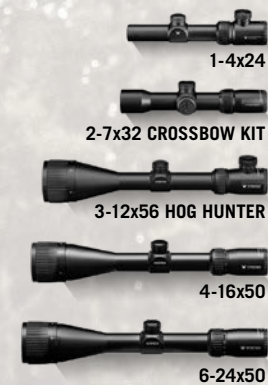

SKU	MAGNIFICATION X OBJECTIVE LENS DIAMETER	FOCAL PLANE	RETICLE	ILLUMINATION	EYE RELIEF	LINEAR FIELD OF VIEW (@ 100 YARDS)	ZERO STOP	TUBE SIZE	LENGTH	WEIGHT
CF2-31045	6-24x50	SFP	Dead-Hold® BDC MOA	No	4.0"	17.3' - 4.4'	N/A	30mm	14.5"	23.0 oz.
CF2-31039	4-16x50	SFP	Dead-Hold® BDC MOA	No	3.7"	25.0' - 3.7'	N/A	30mm	14.4"	23.2 oz.
CF2-31049	3-12x56 Hog Hunter	SFP	V-Brite® MOA	Yes	3.5"	36.7' - 9.2'	N/A	30mm	13.5"	27.9 oz.
CF2-CB1	2-7x32 Crossbow Kit	SFP	XBR-2® MOA	Yes	2.7"	57.5' - 16.4'	N/A	30mm	9.5"	14.0 oz.
CF2-31037	1-4x24	SFP	V-Brite® MOA	Yes	4.0"	96.1' - 24.1'	N/A	30mm	9.6"	15.6 oz.

### FEATURES

- ▶ SD OPTICAL SYSTEM
- ▶ FULLY MULTI-COATED LENSES
- ▶ NITROGEN GAS PURGED
- ▶ WATERPROOF
- ▶ FOGPROOF
- ▶ SHOCKPROOF

For a description of each feature, see page 132. For detailed reticle information, see pages 46-49 or visit [vortexoptics.com](http://vortexoptics.com).



# CROSSFIRE® II

1 INCH TUBE RIFLESCOPE



## HUNT HIGH. HUNT LOW. HUNT HARD.

The clear, tough, and bright optical quality of our popular Crossfire® II line is designed to make similarly priced riflescopes look downright silly. Long eye relief, a fast-focus eyepiece, fully multi-coated lenses, and resettable MOA turrets are hallmarks of the series, not to mention a price point that will leave you plenty of cash to hit the range and the woods in style. Go ahead. Take one for a spin and see what you've been missing.

SKU	MAGNIFICATION X OBJECTIVE LENS DIAMETER	FOCAL PLANE	RETICLE	ILLUMINATION	EYE RELIEF	LINEAR FIELD OF VIEW (@ 100 YARDS)	ZERO STOP	TUBE SIZE	LENGTH	WEIGHT
CF2-31029	6-18x44	SFP	V-Brite® MOA	Yes	3.7"	15.2' - 5.2'	N/A	1"	13.5"	20.8 oz.
CF2-31033			Dead-Hold® BDC MOA	No					19.7 oz.	
CF2-31023	4-12x50	SFP	Dead-Hold® BDC MOA	No	3.9"	25.7' - 8.4'	N/A	1"	14.3"	21.6 oz.
CF2-31015	4-12x44	SFP	Dead-Hold® BDC MOA	No	3.9"	24.7' - 8.4'	N/A	1"	13.4"	15.6 oz.
CF2-31013			V-Plex MOA							
CF2-31019	4-12x40	SFP	Dead-Hold® BDC MOA	No	3.9"	24.7' - 8.4'	N/A	1"	13.6"	18.3 oz.
CF2-31027	3-9x50	SFP	V-Brite® MOA	Yes						18.5 oz.
CF2-31011			Dead-Hold® BDC MOA	No	3.8"	32.0' - 12.9'	N/A	1"	12.8"	18.0 oz.
<b>NEW</b> CF2-31011SW			Straight-Wall BDC MOA							18.4 oz.
CF2-31025	3-9x40	SFP	V-Brite® MOA	Yes						16.0 oz.
CF2-31007			Dead-Hold® BDC MOA	No	3.8"	34.1' - 12.6'	N/A	1"	12.2"	14.8 oz.
CF2-31005			V-Plex MOA	No						
CF2-31002	2-7x32 Scout	SFP	V-Plex MOA	No	9.5"	18.3' - 5.2'	N/A	1"	10.7"	12.0 oz.
CF2-31001R	2-7x32 Rimfire	SFP	V-Plex MOA	No	3.9"	42.0' - 12.6'	N/A	1"	11.5"	13.9 oz.
CF2-31003	2-7x32	SFP	Dead-Hold® BDC MOA	No	3.9"	42.0' - 12.6'	N/A	1"	11.5"	14.3 oz.
CF2-31001			V-Plex MOA							

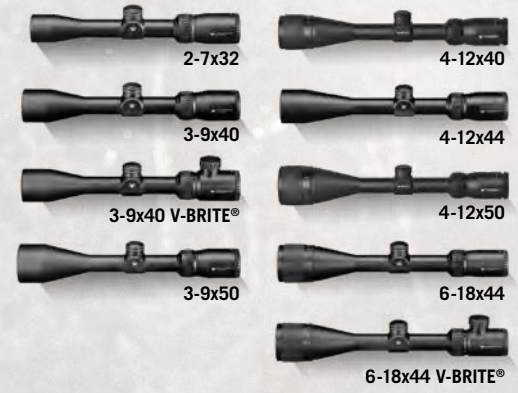

### FEATURES

- ▶ SD OPTICAL SYSTEM
- ▶ FULLY MULTI-COATED LENSES
- ▶ NITROGEN GAS PURGED
- ▶ WATERPROOF
- ▶ FOGPROOF
- ▶ SHOCKPROOF

For a description of each feature, see page 132. For detailed reticle information, see pages 46-49 or visit [vortexoptics.com](http://vortexoptics.com).



VORTEX® WEAR RIFLESCOPES RED DOTS BINOCULARS RANGEFINDERS MONOCULARS SPOTTING SCOPES TRIPODS



# RIFLESCOPE accessories



## PRECISION RIFLESCOPE RINGS

Held to a higher standard and built tough, these rings are machined with certified USA 7075 T6 billet aluminum to an extremely tight tolerance of .0005 inches using a precision computer numeric controlled (CNC) mill.

- 34mm** .92" PMR-34-92 / 1.00" PMR-34-100 / 1.10" PMR-34-1.1  
1.26" PMR-34-126 / 1.45" PMR-34-145
- 30mm** .87" PMR-30-87 / .97" PMR-30-97 / .97" Weaver PMR-30-97-W  
1.26" PMR-30-126 / 1.45" PMR-30-145
- 1 inch** .76" Weaver PMR-01-76-W



## PRO RIFLESCOPE RINGS

The finishing touch for your rifle and optic combination, Pro Rifle Scope Rings combine rock-solid reliability and strength with high quality machining to ensure accuracy and consistency. Streamlined, lightweight, and durable, these rings use four T-25 Torx-style socket cap screws for secure mounting.

- 30mm** Low .90" PR30-L / Medium 1.00" PR30-M / High 1.26" PR30-H  
Extra High 1.54" PR30-XH
- 1 inch** Low .75" PR1-L / Medium .95" PR1-M



## HUNTER RIFLESCOPE RINGS

Simple and reliable, Hunter Rifle Scope Rings mount to a Picatinny or Weaver-type rail. The standard, 2-screw rings are a nice match for general hunting setups when value and reliability are crucial. Made from aircraft-grade 6061-T6 aluminum for optimum strength.

- 30mm** Low .75" 30MRNG-L / Medium .94" 30MRNG-M / High 1.22" 30MRNG-H
- 1 inch** Low .63" RING-L / Medium .87" RING-M / High 1.22" RING-H



### DEFENDER® FLIP CAP

Rifle ranges the world over are littered with broken flip caps, but this is one cap you won't see in the ol' flip cap boneyard. Virtually indestructible, it fits snugly on nearly all Vortex® riflescopes, and features a snap flat spring that keeps your line of sight unobstructed. The E-10 cap has three stop positions. The first is vertical, the second at 45°, and the third at 90° to lay flat.

- Eyepiece E-10**  
**56mm Bell Objective** 0-56    **50mm Bell Objective** 0-50  
**44mm Bell Objective** 0-44    **40mm Bell Objective** 0-40  
**32mm Bell Objective** 0-32    **24mm Bell Objective** 0-24

### TORQUE WRENCH KIT

CTW2

Installing and maintaining precision gear takes precision tools, and this is the one kit you'll need to keep your zero safe. Adjustable in 1 in./lb. increments, this tool is easy to read, simple to set, and offers fast, accurate torque whenever and wherever you need it.



### SUNSHADE

Prepare for every shooting scenario and reduce glare and sun reflection off the objective lens by adding a 4 inch sunshade. Available for select Viper® (44mm and 50mm) and Diamondback® Tactical riflescopes (40mm).

- Viper® 50mm** 50MM-V-SHADE  
**Viper® 44mm** 44MM-V-SHADE  
**Diamondback® Tactical 40mm** DBK-SS4



### SWITCHVIEW™ THROW LEVER

- 46mm** SV-5 / **44mm** SV-4 / **49mm** SV-3 / **44mm** SV-2



### PRECISION QUICK RELEASE EXTENDED CANTILEVER MOUNT

Purpose-built to get your AR on target, this quick release cantilever mount is designed for mounting telescopic sights with 30mm tubes onto a flattop-style AR-15 rifle. This cantilever mount's offset positions the scope in a forward location, providing correct eye relief and head placement when used on an AR-15.

- 30mm** 1.45° CM-404



### PRECISION EXTENDED CANTILEVER MOUNT

The options, and precise machining, you need to get that just-right fit. Available in 30mm, 34mm, and 35mm with options for 20 MOA cant, these extended cantilevers have all the same features as our Precision Rifle Scope Rings, and are designed for mounting scopes with a forward location, providing correct eye relief and head placement.

- 34mm** 1.57° CM-534 / **34mm 20 MOA** 1.57° CM-534-20  
**30mm** 1.57° CM-530 / **30mm 20 MOA** 1.57° CM-530-20



### PRO EXTENDED CANTILEVER MOUNT

If these mounts make you think of freedom it's probably because they're made right here in the USA. These extended cantilever mounts are available in 34mm, 30mm, and 1 inch tube sizes and provide the correct height and forward placement for proper scope mounting.

- 34mm** 1.44° CVP-34 / **30mm** 1.44° CVP-30 / **1 inch** 1.44° CVP-1



### SPORT CANTILEVER RIFLESCOPE MOUNT

Get more comfort and more accuracy out of your AR. Vortex® cantilever ring mounts provide the correct height and forward placement for proper scope mounting on flattop ARs. Available for 1 inch and 30mm tubes in 2 inch or 3 inch offset.

- 30mm** 2 inch offset 1.59° CM-202 / 3 inch offset 1.59° CM-203  
**1 inch** 2 inch offset 1.59° CM-102 / 3 inch offset 1.59° CM-103



### LO PRO BUBBLE LEVEL

- 34mm** LBL-34 / **30mm** LBL-30 / **1 inch** LBL-1



### BUBBLE LEVEL

- 34mm** BL34 / **30mm** BL30 / **1 inch** BL1



# RETICLES

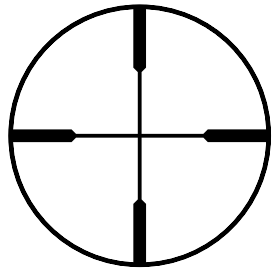

## V-PLEX MOA

The V-Plex is a popular, all-purpose hunting reticle intended for a wide variety of applications.

**Diamondback®** p. 41

**Crossfire® II** p. 43

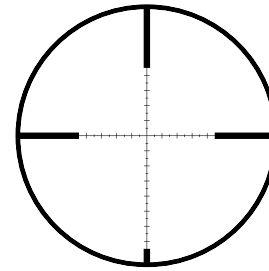

## VMR-1 MOA/MRAD

The VMR-1 is a Second Focal Plane, hashmarked reticle offering accurate holdovers and ranging capability at extended distances. Its simple, intuitive design gives just enough of the information hunters and shooters need while maintaining a clean, clutter-free sight picture.

**Viper® HST™** p. 34

**Diamondback® Tactical** p. 40

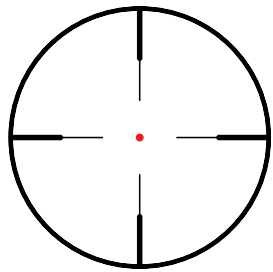

## V-BRITE® MOA

GLASS-ETCHED ILLUMINATED CENTER DOT

Uses the V-Plex format with battery-powered electronics to illuminate the center dot for better low-light performance. Perfect for hunters and shooters during extra low-light conditions.

**Crossfire® II** p. 42 / p. 43

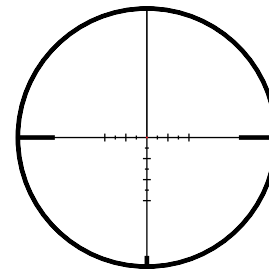

## VMR-2 MOA/MRAD

ILLUMINATED CENTER DOT

The VMR-2 is a Second Focal Plane reticle designed specifically for low-power variable optics. A center illuminated dot makes for fast acquisition on 1x, while hashmarks on the lower and horizontal stadia allow for ranging, holdover, and windage corrections on high power.

**Razor® HD Gen II-E** p. 27

**Viper® PST™ Gen II** p. 33

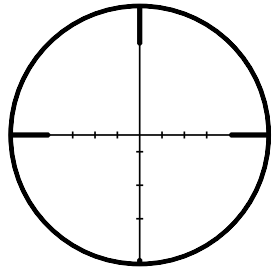

## DEAD-HOLD® BDC MOA

Customized hashmark design helps eliminate guesswork on holdover and windage corrections. Good for hunting and shooting at varying ranges, where estimating holdover is a concern.

**Viper® / HSLR™ / HS™** p. 35

**Diamondback®** p. 41

**Crossfire® II** p. 42 / p. 43

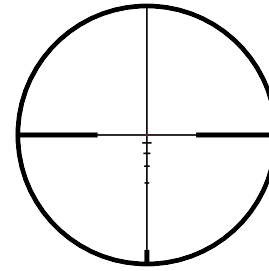

## JM-1 BDC MOA

ILLUMINATED CENTER DOT

Simple, intuitive, and fast. The Vortex® exclusive JM-1 BDC reticle with illuminated center dot was designed with input from world-renowned competitive shooter, instructor, and gunsmith Jerry Miculek. The JM-1 BDC facilitates rapid, accurate shooting at distances from point blank to 600 yards.

**Razor® HD Gen II-E** p. 27

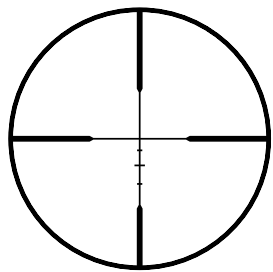

## STRAIGHT-WALL BDC MOA

The Straight-Wall BDC reticle is optimized for popular straight-wall cartridges including .450 Bushmaster, 350 Legend, and .45-70 Government.

**Crossfire® II** p. 43

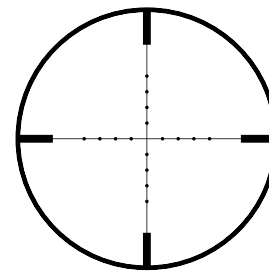

## MIL DOT MOA

The Mil Dot is the original tactical reticle with a long history of use as a rangefinder for snipers when electronic handheld units were not available.

**Viper®** p. 35

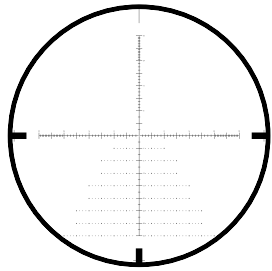

### XLR MOA

The XLR is a hashmarked, MOA-based, long-range reticle with wind drift dots and 1 MOA wind reference subventions. Great for long-range shooters who prefer to dial for bullet-drop and hold for wind at distance.

Viper® HSLR™ p. 35

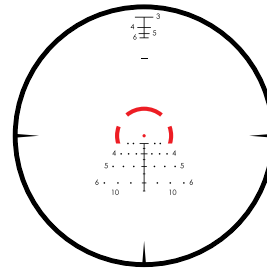

### AR-BDC3 MOA

GLASS-ETCHED ILLUMINATED

Our exclusive AR-BDC3 reticle facilitates rapid shooting at distances out to 650 yards with popular 223/5.56mm and .308/7.62mm loads.

Strike Eagle® p. 37

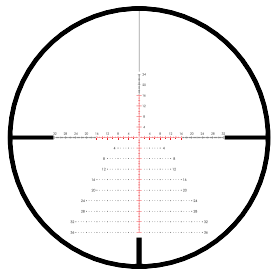

### XLR-2 MOA/MRAD

GLASS-ETCHED ILLUMINATED

The XLR-2 reticle is an illuminated, long-range reticle with elevation and windage reference subventions. Great for long-range shooters and hunters who prefer to hold for bullet-drop and wind at distance.

Razor® HD LHT™ p. 29

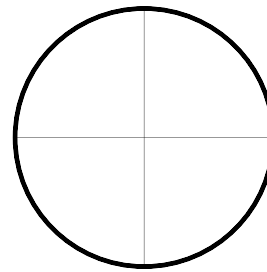

### SCR-1 MOA

GLASS-ETCHED

With ultra-fine reticle thickness, the SCR-1 is a Second Focal Plane reticle designed specifically for bench rest and F-Class shooters who need to be as precise at long-range as possible with minimal target coverage by the reticle.

Golden Eagle® HD p. 31

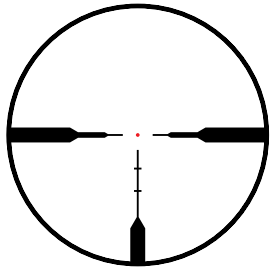

### G4i BDC MRAD

ILLUMINATED CENTER DOT

Can be used effectively with a variety of firearms, including high powered rifles, rimfire rifles, blackpowder rifles, and slug shotguns. Also provides reference marks to compensate for bullet drop and drift in windy conditions.

Razor® HD LHT™ p. 29

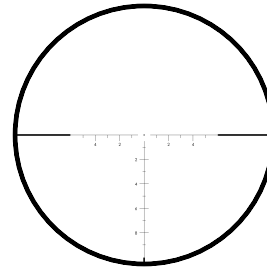

### ECR-1 MOA

GLASS-ETCHED

Slightly thicker than the SCR-1 with additional numbered subventions and a fine center aiming dot, the ECR-1 is a Second Focal Plane optic designed specifically for bench rest and F-Class shooters.

Golden Eagle® HD p. 31

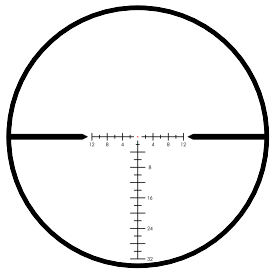

### HSR-5i MOA/MRAD

ILLUMINATED CENTER DOT

Effectively determines ranges, holdovers, windage corrections, and moving target leads. The fine center crosshair subventions provide the optimum balance between precision aiming and low-light visibility.

Razor® HD LHT™ p. 29

# RETICLES

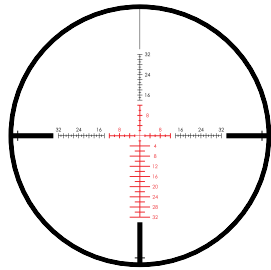

## EBR-4 MOA/MRAD

GLASS-ETCHED ILLUMINATED

The EBR-4 is a Second Focal Plane ranging reticle with subtension lines for ranging and holdovers. A fine, precise center crosshair is complimented by wide hashmarks on the lower stadia for quick windage corrections, despite the lack of a full windage tree.

**Viper® PST™ Gen II** p. 33

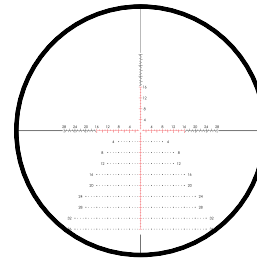

## EBR-7D MOA/MRAD

GLASS-ETCHED ILLUMINATED

Designed to maximize long-distance shooting and ranging abilities, the EBR-7D MOA First Focal Plane reticle can be used to effectively determine ranges, holdovers, windage corrections, and moving target leads.

**Razor® HD Gen III** p. 25

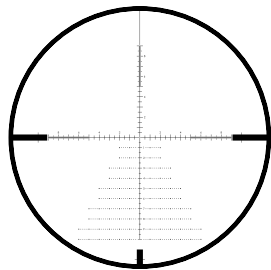

## EBR-2C MOA/MRAD

GLASS-ETCHED

Combining the utility of a hashmark reticle for ranging and holdovers with the fast, easy windage corrections of a windage tree, the first focal plane EBR-2C fits right in with long-range precision and competition shooters.

**Diamondback® Tactical** p. 40

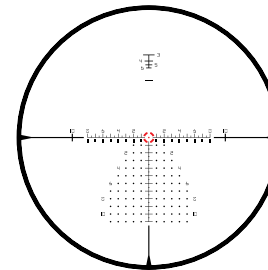

## EBR-9 MRAD

GLASS-ETCHED ILLUMINATED

Designed for use in close-quarters and long-range shooting, the EBR-9 reticle can be used to effectively determine ranges, holdovers, and windage corrections.

**Razor® HD Gen III** p. 25

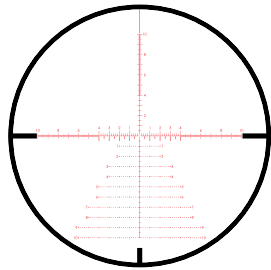

## EBR-7C MOA/MRAD

GLASS-ETCHED ILLUMINATED

The EBR-7C is a hashmarked ranging reticle available in First Focal Plane, packed with useful subtension data for long-range competition shooting or hunting. Hashmarks provide ultra-precise measurements, and a windage tree in the lower stadia have moved to the outside of the windage dots for less obstruction around the vertical stadia itself.

**Razor® HD Gen II** p. 26

**Viper® PST™ Gen II** p. 33

**Strike Eagle®** p. 37

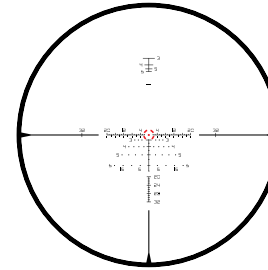

## EBR-9 BDC MOA

GLASS-ETCHED ILLUMINATED

Designed for use in close-quarters and long-range shooting, the EBR-9 BDC reticle adds bullet drop compensation for accurate shots on targets of known distance.

**Razor® HD Gen III** p. 25

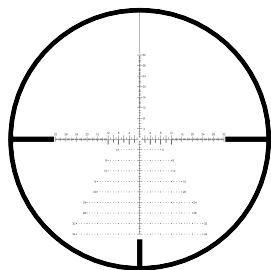

## EBR-7C MOA/MRAD

GLASS-ETCHED

The EBR-7C is a hashmarked ranging reticle available in First Focal Plane, packed with useful subtension data for long-range competition shooting or hunting. Hashmarks provide ultra-precise measurements, and a windage tree in the lower stadia have moved to the outside of the windage dots for less obstruction around the vertical stadia itself.

**Venom®** p. 39



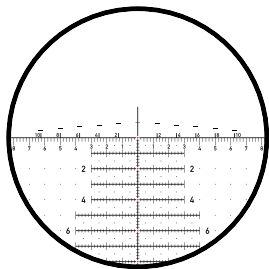

### HORUS™ H59™ MRAD

GLASS-ETCHED ILLUMINATED

An MRAD based reticle with an incredible variety of accommodations for bullet-drop, wind corrections, spotting, and ranging. Designed for long-range precision shooters.

**Razor® HD Gen II** p. 26

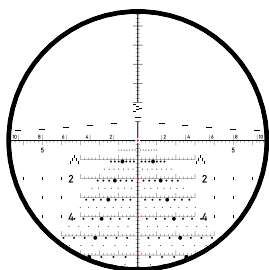

### HORUS™ TREMOR3™ MRAD

GLASS-ETCHED ILLUMINATED

An MRAD based reticle built for long-range precision and even faster transitions, this reticle gets you all the accommodations you need for bullet-drop, wind corrections, spotting, and ranging.

**Razor® HD Gen II** p. 26

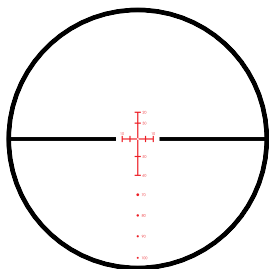

### XBR-2® MOA

GLASS-ETCHED RED/GREEN ILLUMINATED

Designed specifically for use with crossbows. Establish your zero at 40 yards, and you instantly have accurate sub-tensions from 20-100 yards for 275-450 FPS crossbows.

**Crossfire® II** p. 42



# Staff Picks

WE ASKED SOME OF OUR STAFF ABOUT THEIR GO-TO GEAR. FIND OUT WHAT GEAR THEY TRUST TO PACK OUT WHEN GOING ON THEIR HUNT OR HEADING TO THE RANGE.

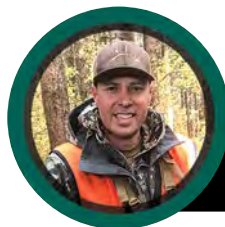

**Mark Boardman**

Content Personality

## PACIFIC NORTHWEST BLACKTAIL RIFLE HUNT

### WHAT'S THE MOST IMPORTANT ITEM IN YOUR KIT?

A dependable rifle and scope combo with good ammo. Nearly everything else can be improvised.

### WHAT'S THE ONE THING YOU ALWAYS SEEM TO FORGET?

I forget my left glove in the field — all the time. I have approximately 72 right-hand gloves. As a righty, my archery release secures the glove on that hand. Consequently, my left glove gets removed for any task requiring tactile dexterity. If anybody comes across 72 left-hand gloves, please call Vortex®.

### DOES ANYTHING IN YOUR KIT HAVE SENTIMENTAL VALUE OR A UNIQUE STORY?

My circa 2004 Browning® A-Bolt Stainless Stalker in 300 WSM is probably my longest standing piece of kit that sees consistent use. We've gone a lot of places and knocked down some critters along the way. I do love that damn thing.

### DO YOU HAVE ANY SUPERSTITIONS?

I have one, but I can't talk about it because not talking about it is part of the superstition.

### IF YOU WERE AN OPTIC, WHICH WOULD YOU BE AND WHY?

I'd be the Razor® HD LHT™ 4.5-22x50. With that scope you are prepared for any hunt under the sun. I like to be prepared, which is why my pack is so full of things I rarely use.

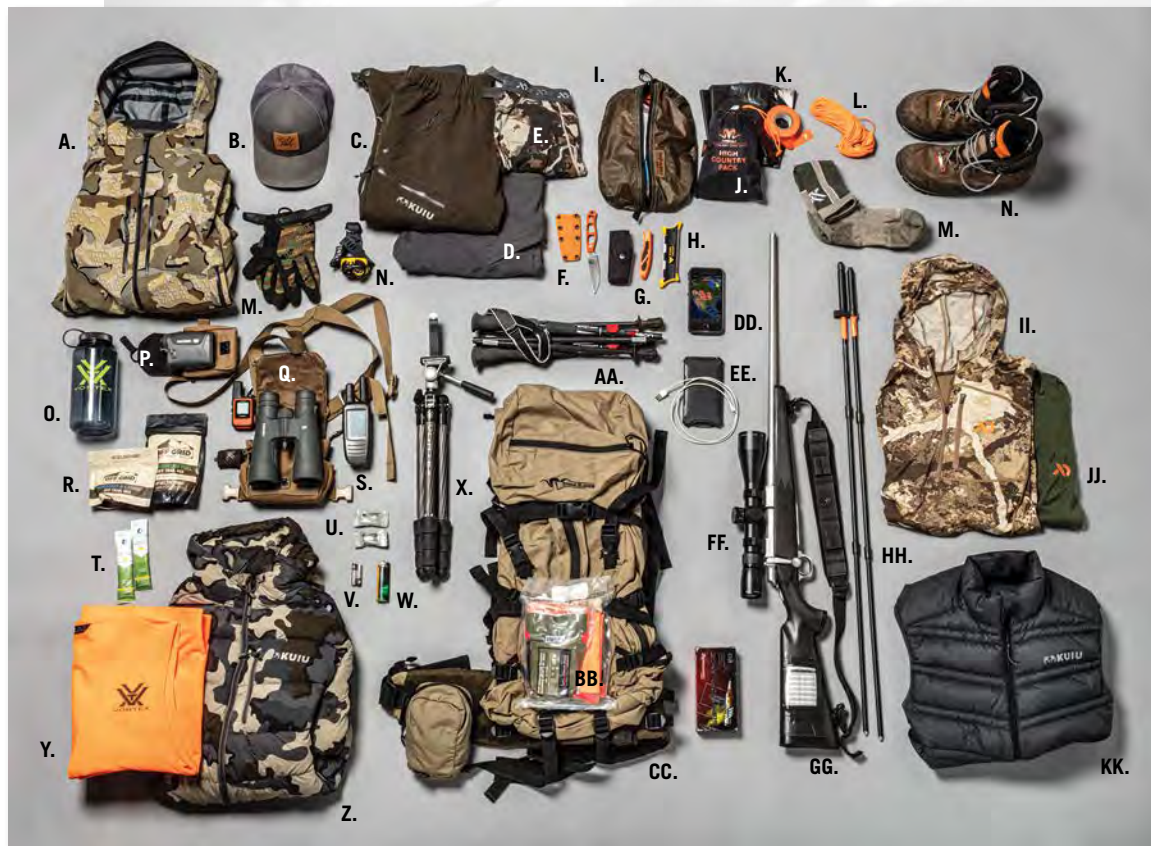

- A. Kuiu® Yukon Rain Jacket
- B. Vortex® Barneveld 608 Cap
- C. Kuiu® Yukon Rain Pants
- D. Kuiu® Attack Pant
- E. First Lite Underwear
- F. Argali Knife
- G. Havalon® Knife
- H. Work Sharp® Pocket Knife Sharpener
- I. Kifaru Pullout Pouch
- J. Argali Game Bags, Two Contractor Bags
- K. Flagging Tape
- L. Rope
- M. Vortex® Game Trail Hunt Socks
- N. Crispi® Lapponia Boots
- O. Nalgene® Water Bottle
- P. Razor® HD 4000 Laser Rangefinder
- Q. Razor® UHD 10x50 Binoculars
- R. Off Grid Food Company Snacks
- S. Garmin® GPS/Radio
- T. Liquid I.V.®
- U. Wet Fire Starter
- V. Batteries
- W. Lighter
- X. Summit™ Carbon II Tripod with Pro Bino Adapter
- Y. Vortex® Outland Pursuit Blaze Vest
- Z. Kuiu® Super Down Pro Hooded Jacket
- AA. Trekking Poles
- BB. North American Rescue® Micro IFAK First Aid Kit
- CC. Stone Glacier® EVO 6900 Pack
- DD. Phone - OnX Maps App
- EE. Dark Energy Poseidon Battery Pack
- FF. Razor® HD LHT™ 4.5-22x50 Riflescope
- GG. Browning® A-Bolt Stainless Stalker Rifle (.300 WSM)
- HH. Shooting Sticks
- II. First Lite Kiln Hoodie
- JJ. First Lite Wick Short Sleeve Crew
- KK. Kuiu® Super Down ULTRA Vest



**Alec Collins**  
Mechanical Engineer

**BREAKS COUNTRY ELK  
ARCHERY HUNT**

**WHAT'S THE MOST IMPORTANT ITEM IN YOUR KIT?**

The most important item in my kit is without a doubt my Razor® UHD 8x42 binoculars. They are the perfect magnification to be able to pick up details when glassing while still having a wide field of view. I was hunting in the Missouri River Breaks, which is pretty open country, so being able to look out across a valley and quickly determine if elk were there or not saved me from wasting time where there weren't elk. Another super important piece of gear is my wind checker. In the breaks, the wind is constantly swirling. I felt like I was checking the wind every five minutes.

**WHAT'S THE ONE THING YOU ALWAYS SEEM TO FORGET?**

I seem to always forget enough toilet paper...You can never bring enough!

**DOES ANYTHING IN YOUR KIT HAVE SENTIMENTAL VALUE OR A UNIQUE STORY?**

I always bring a toy figurine of Frankenstein from Hotel Transylvania the movie in my hunting pack. My girlfriend at the time (now wife) gave it to me as a joke when we were dating. It fell into my pack before a whitetail hunt and I ended up shooting the biggest buck of my life after that happened. I have carried it with me ever since as a good luck charm.

**DO YOU HAVE ANY SUPERSTITIONS?**

I always have to mention to my hunting partner how "it's all over" or "the woods are so dead right now" before I can kill anything. My buddy and I were talking about how Montana kicked our butt and how the hunt was over the night before I ended up shooting my bull!

**IF YOU WERE AN OPTIC, WHICH WOULD YOU BE AND WHY?**

If I were an optic, I would be the Fury® HD 5000 AB. I like to hunt in a very calculated manner like the AB's solving a ballistic equation.



- A. Schnee's Timberline Boots
- B. Vortex® Everyday Main Trail Crew Sock
- C. Razor® Binocular Case
- D. Razor® UHD 8x42 Binoculars
- E. Pro Binocular Adapter
- F. Vortex® Three Peaks Cap
- G. First Lite Brooks Down
- H. Big Agnes Blakburn UL 0
- I. Toilet Paper
- J. Phelps E-Z Estrus Elk Call
- K. Dead Down Wind™ Wind Detector
- L. Sitka Beanie
- M. First Lite Corrugate Guide Pant
- N. Razor® HD 11-33x50
- O. Razor® HD 11-33x50 Case
- P. Summit™ Carbon II Tripod
- Q. Gold Armour Inflatable Pillow
- R. Klymit® Insulated V Ultralite SL
- S. Tru-Fire® Edge Extreme Buckle Foldback
- T. Mathews® Halon
- U. FroggToggs® Pro Lite Top and Bottoms
- V. Mystery Ranch® Beartooth 80
- W. Black Diamond® Trail Ergo Cork
- X. Steripen UV Pen
- Y. Utensils
- Z. Meals, Snacks, Electrolyte Mix
- AA. Jetboil® MiniMo Cook Pot
- BB. First Lite Fuse Quarter Zip
- CC. First Lite Wick Short Sleeve Crew
- DD. Sandals



## Brittani Owens

Marketing Communications  
Coordinator

### MIDWESTERN WHITETAILS RIFLE HUNT

#### WHAT'S THE MOST IMPORTANT ITEM IN YOUR KIT?

Chapstick®!!! There's been some debate as to whether or not the smell scares the deer away. This theory has never been confirmed or denied, so until it is proven either way, I will continue to bring chapstick with me everywhere.

#### WHAT'S THE ONE THING YOU ALWAYS SEEM TO FORGET?

Grunt call — if there is one thing I forget it will be that.

#### DOES ANYTHING IN YOUR KIT HAVE SENTIMENTAL VALUE OR A UNIQUE STORY?

Within the first month of working at Vortex®, I was talking to Jimmy Hamilton about wanting a hunting rifle. I asked for recommendations and he told me the Ruger American®. I said “ok cool, thanks” and not even 5 minutes later I had one ordered for me. And that was how I came to order my first gun.

#### DO YOU HAVE ANY SUPERSTITIONS?

Not really, but I am always worried I will get winded by a deer, so I normally take a few laps in the barn or leave my clothes in the barn for a few days so it smells like cows.

#### IF YOU WERE AN OPTIC, WHICH WOULD YOU BE AND WHY?

Diamondback® HD 8x42s because I'm reliable, and everyone's favorite.

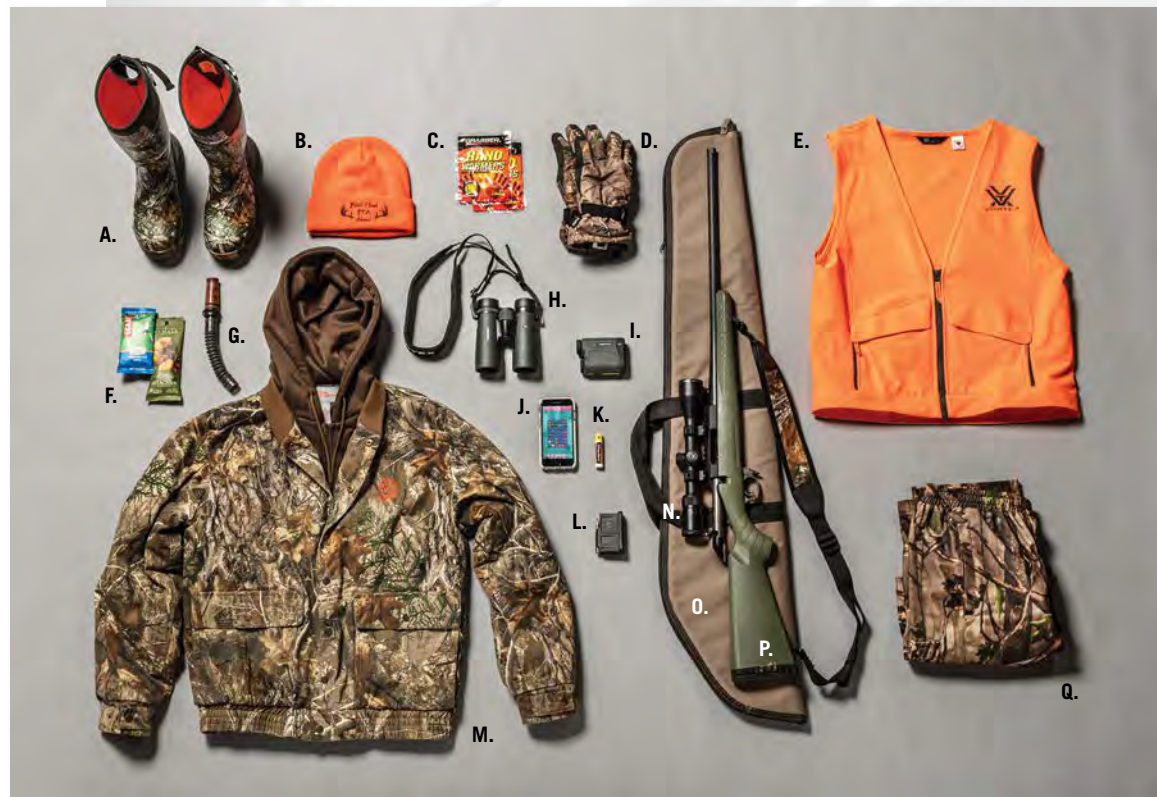

- A. Lacrosse® Boots
- B. Local FFA Blaze Beanie
- C. Hand Warmers
- D. Gloves
- E. Vortex® Outland Pursuit Blaze Vest
- F. Pocket Snacks
- G. Grunt Call
- H. Diamondback® HD 8x42 Binoculars
- I. Impact® 1000 Laser Rangefinder
- J. Fully Charged Phone with Candy Crush
- K. Chapstick®
- L. Magazine
- M. Jacket
- N. Diamondback® 4-12x40 w/ Pro Rings
- O. Rifle Carrying Case
- P. Ruger American® Predator .243 Rifle
- Q. Camo Pants



**Mike Tassoul**

Consumer Sales Specialist

## LONG-RANGE SHOOTING COMPETITION FOCUS

### WHAT'S THE MOST IMPORTANT ITEM IN YOUR KIT?

Everything I have in my kit is important as it all has a specific purpose. That being said, without the rifle/scope I wouldn't be able to do much, so I will say my rifle and optic are the most important.

### WHAT'S THE ONE THING YOU ALWAYS SEEM TO FORGET?

I always manage to forget sunscreen which is why I really like to wear the Vortex® hoodies.

### DOES ANYTHING IN YOUR KIT HAVE SENTIMENTAL VALUE OR A UNIQUE STORY?

I can't say I have anything with sentimental value or any unique story, everything I carry with me is there because it has a purpose.

### DO YOU HAVE ANY SUPERSTITIONS?

Not so much a superstition, but I really think the first stage of a match sets the tone for the day as far as mindset goes. If I have a good first stage, it puts me in a very good mindset and makes the rest of the day a lot easier. If I shoot poorly, it requires me to reset my mind which can be difficult.

### IF YOU WERE AN OPTIC, WHICH WOULD YOU BE AND WHY?

Razor® HD LHT™ 4.5-22x50. I am reliable and can adapt to different situations that are presented to me.



- A. Vasque® Boots
- B. Pnuma™ Tenacity Pants
- C. Badlands Rain Gear Bottoms
- D. Snacks
- E. APA Little Bastard Gen II
- F. Wiebad Mini Fortune Cookie
- G. Sharpies, Pens, & Pencil
- H. Cole Tac Data Binder & Rite in the Rain Notebooks
- I. MDT Ckye Pod
- J. Short Action Precision Sling
- K. Eberlestock® Pack Rain Cover
- L. EAR Inc Molded Ear Plugs
- M. Dope Cards Aluminum
- N. Razor® HD 4000 Laser Rangefinder
- O. Gray Ops Mini Plate & Wiebad Plate Bag
- P. 6.5 Creedmoor Handloads
- Q. Razor® HD Gen III 6-36x56
- R. Vortex® Precision Rifle Chamber Flag
- S. Cole Tac Brass Bag
- T. MDT Magazines - 10 & 12 Round
- U. Cole Tac Arm Information Center
- V. Eberlestock® Lo Drag 2
- W. Accurate Mag® with Area 419 +4 Extension
- X. Foundation Genesis 2 Stock
- Y. Remington 40x Rifle, 6.5 Creedmoor
- Z. Midway® USA Sniper Drag Bag
- AA. Cole Tac Rifle Guardian
- BB. Armageddon Gear Mag Pouches
- CC. Belt and Dump Pouch from Amazon
- DD. Walkers® Electronic Muffs
- EE. Razor® UHD 12x50 Binoculars
- FF. Kestrel® 5700 Elite
- GG. Magnetospeed™ Riflekühl
- HH. Bergara® B14R Magazines & SK Standard Plus Ammo
- II. Leatherman®
- JJ. Radian™ Carbon Tripod with Ball Head
- KK. Evolution Bipod
- LL. Nedved Precision Shooting Mag Block
- MM. Fix It Sticks
- NN. Strike Eagle® 5-25x56 Riflescope
- OO. Bergara® B14R Rifle
- PP. Vortex® Sun Slayer® Hoodie
- QQ. Badlands Rain Gear Top



**Chris Urrutia**

Firearms Instructor & Range Officer at Vortex Edge®

**EVERYDAY CARRY  
CONCEALED CONSIDERATIONS**

**WHAT'S THE MOST IMPORTANT ITEM IN YOUR KIT?**

Next to my brain and sense of awareness, I'd have to say my handheld light. It's the item I use the most and I can get into most anywhere.

**WHAT'S THE ONE THING YOU ALWAYS SEEM TO FORGET?**

As much as I hate to admit this, it's definitely my knife. I use it so much to open packages and day-to-day use that I find myself frantically calling my wife at least once a week to confirm its still where I left it. Where I leave it varies, daily, and on a per use basis.

**DOES ANYTHING IN YOUR KIT HAVE SENTIMENTAL VALUE OR A UNIQUE STORY?**

If I am being honest, I can't say anything has a whole lot of sentimental value. I'm constantly looking for ways to improve and enhance my EDC and I'm not tied down to any one item. I will say that what I carry now gives me a lot of confidence and I'd be hard pressed to carry anything else.

**DO YOU HAVE ANY SUPERSTITIONS?**

I'm not superstitious at all. I have deep rooted faith and believe that so long as I do something every day to make myself harder to kill, be it dryfire, working out, or training, I can be confident that I am ready. I do live by a saying I got from my from my time on SWAT in Charlotte, "If there is any doubt, there's no doubt." These are words I pass on during our courses down at Vortex Edge®.

**IF YOU WERE AN OPTIC, WHICH WOULD YOU BE AND WHY?**

SPARC® SOLAR. I'm a light sleeper and can be on at a moment's notice. I'm dependable and I enjoy time under the sun with my family during beach trips.



- A. Gen 7 Tourniquet
- B. Pocket Trauma Kit
- C. Toor Knives Phoenix Folder
- D. Modlite PLHV2 Handheld Light
- E. Wisemen Company FAT Wallet V1
- F. Tier 1 Concealed Axis Elite Holster

- G. Federal® HST Ammunition, 17 Round Magazine +1 in Chamber, Spare 22 Round Magazine
- H. Gen 5 Glock 45 MOS Chambered in 9mm
- I. Razor® Micro Red Dot - 6 MOA
- J. Surefire® X300U-B 1,000 Lumen Weapon Mount Light



**Liam Ward**  
Product Marketing Manager

**RANGE DAY**  
TRAINING WITH PURPOSE

**WHAT'S THE MOST IMPORTANT ITEM IN YOUR KIT?**

Probably my belt set up, or my first line gear. It has everything on it that I need to sustain what I'm doing, from happy mags to chem lights, gloves, and probably the most important thing, my medical stuff. If we're talking guns, then the Cloud Defensive REIN light on my carbine, or the Ferro Concepts sling because I can't shoot at what I can't identify, and the sling holds the gun to me.

**WHAT'S THE ONE THING YOU ALWAYS SEEM TO FORGET?**

Somehow, I always seem to forget my Uplula® mag loader. RIP thumbs.

**DOES ANYTHING IN YOUR KIT HAVE SENTIMENTAL VALUE OR A UNIQUE STORY?**

Not really, everything on my kit is the result of me testing the crap out of everything and figuring out what works best for me. I could go all-in on why I've chosen every piece of kit I have, but it would take up the entire page so just know it's all because I've tested things and continue to do so. That also includes modifying stuff because what I want doesn't exist. For example, I worked with a really cool guy who makes cut and sew kits and we designed a slick plate carrier placard. We aren't the first to do it, but we were the first to do it this way.

**DO YOU HAVE ANY SUPERSTITIONS?**

I'm not superstitious, but I'm a little bit 'stitious. Just kidding, no not really, I just want to keep training and working to improve every day.

**IF YOU WERE AN OPTIC, WHICH WOULD YOU BE AND WHY?**

An AMG® UH-1® Gen II. It's versatile, and robust. Things I want to be!



- A. London Bridge Trading SBR Bag
- B. Nike® ACG Air Zoom AO Shoes
- C. Walker® Razor Slime Ear Protection
- D. Eye Protection
- E. Vortex® AMG® UH-1® Gen II
- F. Carbine
  - Noveske DEVGRU Clone Pistol. GEN 3 10.5 Upper GEN 1 Lower
  - Unity FAST™ Mount
  - Cloud Defensive REIN Micro
  - L3HARRIS™ ATPIAL-C IR Laser
  - Ferro Concepts Slingster Sling
  - Geissele® SSA-E Trigger
  - Law Tactical Folder
  - Daniel Defense® Magazines
  - Magpul® K2 Grip
- G. Handgun
  - Sig Sauer® P320 Compact Slide
  - Wilson Combat® Frame
  - Grey Ghost Precision Internals
  - Streamlight® TLR-1®
- H. London Bridge Trading Tool Bag
- I. Plate Carrier
  - Crye Precision™ JPC 2.0 MCB
  - Crye Precision™ AVS M4 Front Pouch with Modified Esstac Kywi Kydex Inserts
  - Qilo Tactical Convertible Dangler Pouch
  - Ferro Concepts Wing Thing™
  - SOG SEAL FX Tanto Knife
  - Premier Body Armor Stratis LVL 3+ Enhanced Plates
- J. Nixon® Regulus Watch
- K. Esstac Kywi Mag Pouches
- L. Chem Lights
- M. Mechanix® Wear Gloves
- N. Belt
  - London Bridge Trading GBRS Assaulters Belt
  - True North Concepts Modular Holster Adapter with Leg Strap
  - Safariland® QLS Plate and Receiver
  - Trex Arms Ragnarok Holster
  - Trex Arms Medical Pouch
- O. Ferro Concepts Pro Hat



VIP WARRANTY



**HUNGRY DOG**



**BINOCULAR**

VORTEXOPTICS.COM





**UNLIMITED.  
UNCONDITIONAL.  
LIFETIME WARRANTY.**

**COVERED.**

“

Life has blessed me with a beautiful wife, two boys 6 and 7 who love the outdoors as much as I do, a high-energy four-legged friend adopted from the local animal shelter that for reasons unknown is in a perpetual puppy stage, and Vortex Optics. I hunt a lot. One thing that's always on my chest are my Vortex binoculars. My kids, bless their hearts, tend to borrow them for their intense indoor glassing sessions. Apparently, they work great for spotting big bucks hiding behind things like the couch or a freestanding lamp. My boys are great at finding my binos — not so great at putting them away. This is where Dixie, my dog, comes in. I've walked in on a few shocking things in my life, but seeing my beloved Diamondbacks chewed to pieces on the living room floor takes the cake. Just like that, an invaluable piece of hunting gear rendered useless. Dixie is fine. Enter Vortex Customer Service. You guys took care of me with a smile. You didn't hassle me and even joked with me about the unfortunate situation. Best of all, you replaced my binoculars in time for my next hunt. You exceeded my every expectation, and have a customer for life.”

—ANONYMOUS

Vortex® will repair or replace the product. Absolutely free—no matter the cause. Does not cover loss, theft, deliberate damage, or cosmetic damage that does not hinder the performance of the product.



# red dots



RED DOTS COMPARISON

VORTEXOPTICS.COM

# RED DOTS COMPARISON CHART

## RED DOTS & HOLOGRAPHIC SIGHTS



	AMG® UH-1® GEN II	SPARC® SOLAR	SPARC® AR	STRIKEFIRE® II	CROSSFIRE®
<b>Dot Size</b>	EBR-CQB 1 MOA	2 MOA	2 MOA	4 MOA	2 MOA
<b>Illumination Settings</b>	15 (8 Night-Vision)	10 (2 Night-Vision)	10 (2 Night-Vision)	11 (2 Night-Vision)	9 (2 Night-Vision)
<b>Control Type</b>	Rear Buttons	Side Button (Motion Activation)	Rear Buttons	Rear Buttons	Dial
<b>Mounting Height</b>	Lower 1/3 Co-Witness Integrated QD Mount	Low Mount, Lower 1/3 Co-Witness	Absolute Co-Witness, Lower 1/3 Co-Witness	Lower 1/3 Co-Witness Cantilever	Low Mount, Lower 1/3 Co-Witness
<b>Mount Type</b>	Picatinny	Picatinny	Picatinny	Picatinny and Weaver®	Picatinny and Weaver®
<b>Battery Type</b>	CR123A	CR2032, Solar	AAA	CR2	CR2032
<b>Footprint</b>	N/A	Micro Mount	Micro Mount	N/A	Micro Mount

## MICRO RED DOTS



	RAZOR®	VIPER®	VENOM®
<b>Dot Size</b>	3 MOA, 6 MOA	6 MOA	3 MOA, 6 MOA
<b>Illumination Settings</b>	10	8 (2 Night-Vision)	10
<b>Control Type</b>	Rear Buttons	Side Buttons	Side Buttons
<b>Mounting Compatibility</b>	Low	Low	Low
<b>Footprint</b>	C-More or Included Picatinny Mount	Fastfire	Fastfire
<b>Battery Type</b>	CR2032	CR2032	CR1632
<b>Battery Placement</b>	Side Door	Bottom	Top

## PRISM SCOPES



	SPITFIRE™ HD GEN II	SPITFIRE™ AR
<b>Magnification</b>	3x, 5x	1x
<b>Reticle</b>	AR-BDC4 Etched Reticle	DRT MOA Etched Reticle
<b>Illumination Settings</b>	10 (2 Night-Vision)	12
<b>Control Type</b>	Side Buttons	Rear Buttons
<b>Mounting Heights</b>	Low Mount, Lower 1/3 Co-Witness	Lower 1/3 Co-Witness
<b>Footprint</b>	Micro Mount	N/A
<b>Battery Type</b>	CR2032	AAA
<b>Mount Type</b>	Picatinny	Picatinny



AMG® UH-1® GEN II



unstoppable,  
DAY OR NIGHT.

VORTEXOPTICS.COM

# AMG<sup>®</sup> UH-1<sup>®</sup> GEN II

HOLOGRAPHIC SIGHT



ZERO IMAGE DISTORTION

NIGHT-VISION COMPATIBILITY WITH DEDICATED NV BUTTON

INTEGRATED QUICK-RELEASE MOUNT

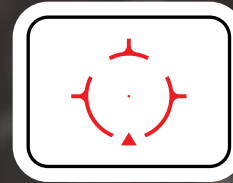

### EBR-CQB 1 MOA RETICLE

The clean, highly versatile, purpose-built reticle creates optimal target engagement in a wide range of scenarios.

## UNSTOPPABLE, DAY OR NIGHT.

When you rely on a tactical optic to keep you in the game, you've got to be ready to shine, day or night. The AMG<sup>®</sup> UH-1<sup>®</sup> Gen II is the close-quarters solution you've been asking for, offering an incredibly fast holographic display to conquer every close-quarters situation, now with night-vision compatible settings and a dedicated night-vision button. A large viewing window makes this door-kicker even faster, and a sleek, snag-free build looks and maneuvers great. The lightning-quick EBR-CQB reticle is designed to dominate in close-quarters, and our FHQ<sup>™</sup> technology virtually eliminates stray light emissions for stealth shooting. Duty never sleeps, and the AMG<sup>®</sup> UH-1<sup>®</sup> Gen II is ready to light your way.

### FHQ<sup>™</sup> Technology

Fusion Hologram with Quantum Well Light Control (FHQ) Technology virtually eliminates stray light emissions for stealth shooter signature in low light and prevents eyepiece glare common to other holographic sights.

### FEATURES

- ▶ XR<sup>™</sup> PLUS LENS COATING
- ▶ WATERPROOF
- ▶ ARMORTEK<sup>®</sup>
- ▶ FOGPROOF
- ▶ SHOCKPROOF

For a description of each feature, see page 132.

SKU	RETICLE	DOT COLOR	BATTERY TYPE	EYE RELIEF	MAGNIFICATION	LENGTH	WEIGHT (W/ BATTERY)
AMG-HS02	EBR-CQB 1 MOA	Bright Red	CR123A	Unlimited	1x	3.9"	11.6 oz.





SPARC® SOLAR



**CARRY THE SUN INTO  
the storm.**

VORTEXOPTICS.COM

# SPARC<sup>®</sup> SOLAR

RED DOT



## BATTERY LIFE

The daylight bright red dot is easy to see and paints targets regardless of lighting conditions or background.

DOT COLOR	USING SOLAR POWER AND BATTERY POWER
Bright Red	150,000 Hours



2 MOA RED DOT



SOLAR PANEL

## CARRY THE SUN INTO THE STORM.

The latest iteration of our SPARC<sup>®</sup> series of red dots now harnesses the power of the sun for up to 150,000 hours of battery life, powering a reliable tactical machine ready to help you protect what matters most. Our smartest red dot to date, the SPARC<sup>®</sup> SOLAR's Auto D-TEC technology automatically switches from solar to battery power when the sun can't power the dot to your choice of 10 daytime illumination settings and two night-vision compatible settings. Motion activation capable, the SPARC<sup>®</sup> is always ready, and its daylight bright, 2 MOA dot provides a clear, precise point of aim. Near and far, night and day, the SPARC<sup>®</sup> SOLAR means you're always ready.



SKELETONIZED MOUNT INCLUDED

## FEATURES

- ▶ FULLY MULTI-COATED LENSES
- ▶ WATERPROOF
- ▶ NITROGEN GAS PURGED
- ▶ FOGPROOF
- ▶ SHOCKPROOF

For a description of each feature, see page 132.

SKU	DOT SIZE	DOT COLOR	BATTERY TYPE	EYE RELIEF	MAGNIFICATION	LENGTH	WEIGHT (W/ BATTERY & HIGHEST MOUNT)
SPC-404	2 MOA	Bright Red	CR2032	Unlimited	1x	2.6"	5.9 oz.





SPARC® AR



IT TAKES A SPARC  
TO LIGHT A FIRE.

VORTEXOPTICS.COM



# SPARC<sup>®</sup> AR

RED DOT

12-HOUR AUTO SHUTOFF

NIGHT-VISION  
COMPATIBILITY

REAR-FACING ILLUMINATION CONTROL

## BATTERY LIFE

The daylight bright red dot is easy to see and paints targets regardless of lighting conditions or background.

DOT COLOR	ON ILLUMINATION SETTING 6
Bright Red	50,000 Hours

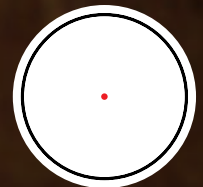

2 MOA RED DOT

## IT TAKES A SPARC TO LIGHT A FIRE.

Looking for the one optic you need to max your AR's effectiveness in any environment? The SPARC<sup>®</sup> AR features compact, rugged construction with a lightweight form-factor and 50,000 hours of battery life. To make that battery last even longer, we've built in an auto shutoff. The 2 MOA dot is as easy as point and shoot — quick to acquire in close-quarters, but fine enough for pin-point accuracy at extended ranges. Plus, it's night-vision compatible on the two lowest illumination settings. A unique, integrated base is hassle-free on any AR, or similar platform, and rear-facing digital controls make adjusting to your situation fast and easy. For reliable performance and loads of user-friendly features, look no further.

## FEATURES

- ▶ FULLY MULTI-COATED LENSES
- ▶ NITROGEN GAS PURGED
- ▶ WATERPROOF
- ▶ FOGPROOF
- ▶ SHOCKPROOF

For a description of each feature, see page 132.



SKU	DOT SIZE	DOT COLOR	BATTERY TYPE	EYE RELIEF	MAGNIFICATION	LENGTH	WEIGHT (W/ BATTERY)
SPC-AR2	2 MOA	Bright Red	AAA	Unlimited	1x	2.9"	8.6 oz.



# STRIKEFIRE® II

RED DOT

STRIKEFIRE® II / CROSSFIRE®



### BATTERY LIFE

DOT COLOR	ON ILLUMINATION SETTING 6
Bright Red	50,000 Hours
Red/Green	360 Hours

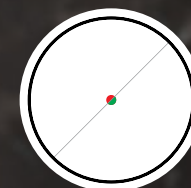

4 MOA RED/GREEN DOT

## STRIKE WHILE THE BARREL'S HOT.

Can going bigger actually make you faster? It can when you're talking about field of view. The Strikefire® II's larger objective and 30mm tube provide a larger field of view and allow it to be mounted at just about any height using most common 30mm rings. The 4 MOA dot is easy to acquire quickly and is available in red-only or user-selected red/green models. From AR-15s to shotguns, the Strikefire® II offers super-fast, big-time versatility at a price that leaves you plenty of cash for ammo.

### FEATURES

- ▶ FULLY MULTI-COATED LENSES
- ▶ WATERPROOF
- ▶ NITROGEN GAS PURGED
- ▶ FOGPROOF
- ▶ SHOCKPROOF

SKU	DOT SIZE	DOT COLOR	BATTERY TYPE	EYE RELIEF	MAGNIFICATION	LENGTH	WEIGHT (W/ BATTERY & HIGHEST MOUNT)
SF-BR-504	4 MOA	Bright Red	CR2	Unlimited	1x	5.6"	12.8 oz.
SF-RG-501	4 MOA	Red/Green	CR2	Unlimited	1x	5.6"	12.8 oz.

For a description of each feature, see page 132.



# CROSSFIRE®

RED DOT



NIGHT-VISION  
COMPATIBILITY

MULTI-HEIGHT  
SKELETONIZED  
MOUNT INCLUDED

## BATTERY LIFE

The daylight bright red dot is easy to see and paints targets regardless of lighting conditions or background.

DOT COLOR	BATTERY LIFE
Bright Red	50,000 Hours

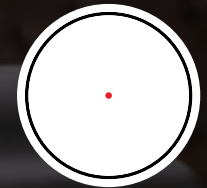

2 MOA RED DOT

## MAKE IT RAIN BRASS, RAIN OR SHINE.

The Crossfire® is a no-nonsense sight at a no-nonsense price for darn near any application. When your AR-15, shotgun, or rimfire needs a simple point of aim and none of the frills, the Crossfire® should be at the top of your list. The 2 MOA dot is quick to acquire in close-quarters, while remaining fine enough for dead-on accuracy at extended ranges. You also get 50,000 hours of battery life, plus night-vision compatibility on the two lowest illumination settings. In addition to just plain looking awesome, the included skeletonized lower 1/3 co-witness mount provides a rock-solid, extremely lightweight platform.



SKELETONIZED MOUNT INCLUDED

## FEATURES

- ▶ FULLY MULTI-COATED LENSES
- ▶ WATERPROOF
- ▶ NITROGEN GAS PURGED
- ▶ FOGPROOF
- ▶ SHOCKPROOF

For a description of each feature, see page 132.

SKU	DOT SIZE	DOT COLOR	BATTERY TYPE	EYE RELIEF	MAGNIFICATION	LENGTH	WEIGHT (W/ BATTERY & HIGHEST MOUNT)
CF-RD2	2 MOA	Bright Red	CR2032	Unlimited	1x	2.5"	5.3 oz.





# RAZOR®

MICRO RED DOT

RAZOR® / VIPER® / VENOM®



The daylight bright red dot is easy to see and paints targets regardless of lighting conditions or background.

## EDGE OUT THE COMPETITION.

An open-top reflex sight built for top-tier performance and incredible versatility, the Razor® belongs on your go-to guns. Whether it's a competition rifle or your everyday carry, the large, clear, and crisp window provides edge-to-edge sharpness with a wide field of view protected by a thick, durable, aluminum housing. Choose a 3 MOA dot for finer rifle work or go 6 MOA for rapid acquisition on a handgun or shotgun. A side-load battery tray makes for quick battery changes without removing the sight. Rugged and durable, the Razor® comes in at 1.3 ounces (2.3 ounces with its included, low Picatinny mount).

SKU	DOT SIZE	DOT COLOR	BATTERY TYPE	EYE RELIEF	MAGNIFICATION	LENGTH	WEIGHT (W/ BATTERY & MOUNT)
RZR-2001	3 MOA	Bright Red	CR2032	Unlimited	1x	1.8"	2.3 oz.
RZR-2003	6 MOA	Bright Red	CR2032	Unlimited	1x	1.8"	2.3 oz.

### FEATURES

- ▶ XR™ LENS COATINGS
- ▶ WATERPROOF
- ▶ ARMORTEK®
- ▶ SHOCKPROOF

For a description of each feature, see page 132.



VORTEXOPTICS.COM

# VIPER®

MICRO RED DOT



## TARGET ACQUIRED.

Red dots for sidearms better be low-profile and tough. Viper® fits the bill, and its low mounting height is perfect for handguns with cutout slides. The simplicity and speed of a red dot while co-witnessing with suppressor-height iron sights means you're always ready. The included low Picatinny rail mount allows for additional mounting options.

### FEATURES

- ▶ FULLY MULTI-COATED LENSES
- ▶ WATERPROOF
- ▶ ARMORTEK®
- ▶ SHOCKPROOF

For a description of each feature, see page 132.

SKU	DOT SIZE	DOT COLOR	BATTERY TYPE	EYE RELIEF	MAGNIFICATION	LENGTH	WEIGHT (W/BATTERY & MOUNT)
VRD-6	6 MOA	Bright Red	CR2032	Unlimited	1x	1.8"	2.0 oz.

## BUILT FOR YOUR MOMENTS OF TRUTH.

Get fast target acquisition and a sleek form factor that won't snag. The low-profile housing on the Venom® surrounds a large viewing window with next-to-no obstruction for rapid shooting transitions. The included low Picatinny rail mount allows for additional mounting options.

### FEATURES

- ▶ FULLY MULTI-COATED LENSES
- ▶ WATERPROOF
- ▶ ARMORTEK®
- ▶ SHOCKPROOF

For a description of each feature, see page 132.

# VENOM®

MICRO RED DOT



SKU	DOT SIZE	DOT COLOR	BATTERY TYPE	EYE RELIEF	MAGNIFICATION	LENGTH	WEIGHT (W/ BATTERY & MOUNT)
VMD-3103	3 MOA	Bright Red	CR1632	Unlimited	1x	1.9"	1.7 oz.
VMD-3106	6 MOA	Bright Red	CR1632	Unlimited	1x	1.9"	1.7 oz.





# SPITFIRE™ HD GEN II

## PRISM SCOPE

SPITFIRE™ HD GEN II / SPITFIRE™ AR



MRDS MOUNT  
(FITS VIPER® AND  
VENOM® RED DOTS)

MULTI-HEIGHT MOUNT

NIGHT-VISION  
COMPATIBILITY



A BDC reticle built to get the most out of the 5.56 cartridge in your AR, this reticle provides both rapid target acquisition and the tools for holdovers out to 650 yards.



AR-BDC4 MOA RETICLE

### BUILT SMALL TO GO BIG.

Leaner, meaner, and featuring a redesigned HD optical system for a significantly smaller, lighter tactical solution, the new Spitfire™ HD Gen II 3x and 5x models let you choose your ideal mounting height while cutting inches and ounces off the original platform. Now with night-vision compatibility, it's a shooter's dream come true, running on a BDC-style reticle designed to subtend with most popular 5.56 cartridges for quick holdovers at known distances to keep you locked on target. Plus, the prism design and etched reticle give you ultra-fast target while still functioning without illumination, and the turrets are exposed — no more caps, no more snags. Admit it. You're already picturing one on your go-to.

Note – Prism scopes are not compatible with magnifiers.



3x



5x

#### FEATURES

- ▶ HD OPTICAL SYSTEM
- ▶ FULLY MULTI-COATED LENSES
- ▶ NITROGEN GAS PURGED
- ▶ WATERPROOF
- ▶ FOGPROOF
- ▶ SHOCKPROOF

SKU	MAGNIFICATION	RETICLE	RETICLE COLOR	LINEAR FIELD OF VIEW (@ 100 YARDS)	EYE RELIEF	BATTERY TYPE	LENGTH	WEIGHT (W/ BATTERY & HIGHEST MOUNT)
SPR-500	5x	AR-BDC4 MOA	Red	23.3'	2.7"	CR2032	3.6"	10.8 oz.
SPR-300	3x	AR-BDC4 MOA	Red	37.9'	2.6"	CR2032	3.0"	9.3 oz.

For a description of each feature, see page 132.



# SPITFIRE™ AR

PRISM SCOPE



The DRT (Dual Ring Tactical) reticle is designed for rapid shooting at close distances. The dual ring design pulls the eye into instant alignment with the reticle center and target.

## DOOR KICKING, DOWN RANGE BANG MACHINE.

When all else fails, the Spitfire™ AR won't. The glass-etched DRT (Dual Ring Tactical) reticle can be used with or without the red/green illumination like a traditional riflescope, and makes target and reticle acquisition in close-quarters a snap. Unique to the Spitfire™ AR, an included 5.56 BDC turret allows shooters to dial popular AR-15 configurations to 700 yards — perfect for limited division 3-Gun competitors or shooters who want to engage targets at all ranges. Plus, it's the perfect solution if you need a 1x optic designed for close-quarters but common astigmatism renders other red dots unusable.

Note – Prism scopes are not compatible with magnifiers.

SKU	MAGNIFICATION	RETICLE	RETICLE COLOR	LINEAR FIELD OF VIEW (@ 100 YARDS)	EYE RELIEF	BATTERY TYPE	LENGTH	WEIGHT (W/ BATTERY)
SPR-200	1x	DRT MOA	Red/Green	79'	3.8"	AAA	4.5"	11.2 oz.

### FEATURES

- ▶ FULLY MULTI-COATED LENSES
- ▶ WATERPROOF
- ▶ NITROGEN GAS PURGED
- ▶ FOGPROOF
- ▶ SHOCKPROOF

For a description of each feature, see page 132.





# RED DOT accessories

**NEW**



## MICRO6X

MAGNIFIER  
V6XM

### TAKE YOUR RED DOT 6X FARTHER.

Easy on, easy off, and built to fit seamlessly onto your rifle, the Micro6x Magnifier delivers an incredibly compact 6x optical system that takes your red dot further, maximizing the versatility of your weapon. Incredibly compact, the Micro6x Magnifier still provides durable, robust functionality that stands up to abuse in the field. You also get everything you need to mount up, right out of the box. Take your pick of three mounting heights (absolute co-witness, lower 1/3 co-witness, and 1.93" with included riser) and hit harder and farther than you ever thought possible.

Note - The Micro6x Magnifier is recommended for use with Vortex® AMG® UH-1®, SPARC® SoIAR, and Strikefire® II sights.  
The Micro6x Magnifier will not work with prism scopes.

SKU	MAGNIFICATION	OBJECTIVE LENS DIAMETER	LINEAR FIELD OF VIEW (@ 100 YARDS)	ANGULAR FIELD OF VIEW	EYE RELIEF	LENGTH	WEIGHT
V6XM	6x	28mm	19.1'	3.7°	2.5"	4.3"	10.9 oz.





# MICRO3X

MAGNIFIER  
V3XM

## MAG ON. MAG OFF.

Next level 3x magnification versatility when you need it for your red dot or holographic sight in an ultra-compact, lightweight, and optically crisp package. Integrated quick-release allows fast attach/detach while a patented cam-lock design engages/disengages magnifier with direct pressure. Adjustable flip mount allows for right or left-handed use.

Note – The Micro3x Magnifier will work with any of our red dots. Any existing parallax in the optic will also be magnified. The Micro3x will not work with prism scopes.

SKU	MAGNIFICATION	OBJECTIVE LENS DIAMETER	LINEAR FIELD OF VIEW (@ 100 YARDS)	ANGULAR FIELD OF VIEW	EYE RELIEF	LENGTH	WEIGHT
V3XM	3x	22mm	38.2'	7.3°	2.6"	2.9"	9.6 oz.



# VMX-3T

MAGNIFIER  
VMX-3T

## MAKE LIGHT WORK OF LONG-RANGE.

Extend your reach with the simple, push-button design of the VMX-3T. One button engages and disengages the flip-mount, allowing the magnification to lock in place. The result? 3x magnified or unmagnified views at will. Optics are fully multi-coated for optimal light transmission. Lightweight and tough, the anodized, machined-aluminum construction ensures durability. Internally nitrogen purged for reliable waterproof and fogproof performance. Ultimate magnified versatility for virtually any AR-height red dot.

Note – The VMX-3T Magnifier will work with any of our red dots. Any existing parallax in the optic will also be magnified. The VMX-3T will not work with prism scopes.

SKU	MAGNIFICATION	OBJECTIVE LENS DIAMETER	LINEAR FIELD OF VIEW (@ 100 YARDS)	ANGULAR FIELD OF VIEW	EYE RELIEF	LENGTH	WEIGHT
VMX-3T	3x	27mm	38.2'	7.3°	2.2"	4.3"	11.9 oz.



**CR2032 BATTERY HOLDER**  
BH-2032



**SPORT CANTILEVER RED DOT RING**  
30mm Ring Lower 1/3 Co-Witness CM-304  
30mm Ring Absolute Co-Witness CM-305



**TACTICAL 30MM RING**  
30mm Low TRL / Medium TRM / High TRH  
Extra-High Lower 1/3 TRXH / Extra-High Absolute TRXHAC



**MOUNT RISER-QR**  
RDMQ



**45 DEGREE MOUNT**  
45RDM



**AR15 RISER MOUNT**  
(FOR RAZOR® RED DOT)  
MT-5108



**RAZOR® RT45 OFFSET MOUNT**  
MT-5109





# binoculars



BINOCULARS COMPARISON

VORTEXOPTICS.COM

# BINOCULARS

## COMPARISON CHART



RAZOR® UHD

RAZOR® HD

KAIBAB® HD

VIPER® HD

DIAMONDBACK® HD

CROSSFIRE® HD

	RAZOR® UHD	RAZOR® HD	KAIBAB® HD	VIPER® HD	DIAMONDBACK® HD	CROSSFIRE® HD
<b>Configurations</b>	18x56 12x50 10x50 10x42 8x42	12x50 10x50 10x42 8x42	18x56	12x50 10x50 10x42 8x42	15x56 12x50 10x50 10x42 8x42 10x32 8x32 10x28 8x28	12x50 10x50 10x42 8x42

### KNOW THE NUMBERS



10 x 42

#### The First Number

Refers to the magnification provided by the binocular. As magnification increases, image detail also increases, but field of view decreases and it becomes more difficult to steadily handhold the binoculars.

#### The Second Number

Refers to the diameter of the objective lens. As the objective size increases the binocular allows in more light providing brighter images. At the same time, the binocular increases in size and weight.

### WHICH CONFIGURATION IS BEST FOR ME?

8x42	10x42	10x50 / 12x50	15x56 / 18x56
An 8x42 binocular is a light-weight configuration, ideal for scanning areas that are densely wooded, have wide expanses or scenes with lots of movement.	A 10x42 is a do-it-all binocular configuration with lightweight benefits of the 8x42, but more powerful magnification.	The 10x50 or 12x50 is often used for scanning longer distances. With a wider field of view than a spotting scope, it bridges the gap between high-magnification models that require a tripod and handheld options for the backcountry.	The 15x56 and 18x56 reduce pack weight and bulk by eliminating the need of a spotting scope from your kit. Pick apart distant landscapes with these tripod-mounted configurations.

# HOW TO CHOOSE YOUR BINOCULAR

## ◀◀ PICK YOUR APPLICATION ▶▶



### WESTERN HUNTING

Rugged, mountain country and vast open landscapes define the west. Quality optics are essential for methodically dissecting game-hiding terrain at extreme distances. Your buck or bull is out there, the right optics will help you find him.

12x  
18x

#### MAGNIFICATION

Big country, bigger glass — it's important to let your eyes do the walking. More magnification will help you find, identify, and evaluate big game at distance. As magnification increases, steadiness decreases. Use a tripod when glassing with higher power binoculars for rock-steady viewing.

#### OBJECTIVE SIZE

All else equal (model/magnification), a larger objective increases the size of a binocular's exit pupil. A larger exit pupil allows more light to hit your eye, and increases the binocular's ability to perform in low-light scenarios. A larger objective results in an overall bigger binocular, adding weight and bulk. All things to consider when making your selection.

#### OPTICS

Optical quality is critical to pick apart the landscape efficiently, and when you're spending hours behind glass, reduces eye fatigue. Choose the best optical system you can afford for superior image resolution, clarity, and color accuracy.

#### OUR BINOCULAR RECOMMENDATION:

GOOD: Viper® HD 10x50, 12x50

BETTER: Razor® HD 12x50

BEST: Razor® UHD 12x50, 18x56

Note – When using a binocular over 12x, it is highly recommended to use a tripod for stabilization.



### MIDWESTERN AND EASTERN HUNTING

Turkeys to whitetails, cropland to dark timber, Midwestern and Eastern hunters know the importance of the right optic.

8x  
10x

#### MAGNIFICATION

Less is more when it comes to magnification. Reduced magnification provides a wider field of view and better light transmission. Translation — you'll get on target quicker and glass more effectively early and late in the day.

#### OBJECTIVE SIZE

Comparing two binoculars of equal objective diameter, the binocular of lower magnification produces a larger exit pupil. This means more light to hit your eye, which aids in low-light performance and maximizes your hunting and observation hours.

#### OPTICS

Most animals are on the move at dawn and dusk. Having optics that excel in low-light situations will give you the clarity and detail you need when daylight fades.

#### OUR BINOCULAR RECOMMENDATION:

GOOD: Crossfire® HD 8x42

BETTER: Diamondback® HD 10x42

BEST: Viper® HD 10x42, 10x50



# HOW TO CHOOSE YOUR BINOCULAR

«« PICK YOUR APPLICATION »»



## RECREATIONAL GLASSING

Nature doesn't stand still. Whether you're a casual wildlife observer or dedicated birder, optical quality is a critical factor to get the most of your time outdoors.

8x  
10x

### MAGNIFICATION

Generally speaking, wildlife observation doesn't require high-powered magnification. An optic with wider field of view will allow for quick target identification to ensure you don't miss anything.

### OBJECTIVE SIZE

Big glass is hard to hold steady. Size down to a binocular with a smaller objective lens to cut weight for easier handling.

### OPTICS

Never misidentify a critter again! Besides realistic color representation, an optic with superior color fidelity is essential for identifying targets as accurately as possible.

### OUR BINOCULAR RECOMMENDATION:

GOOD: Crossfire® HD 8x42

BETTER: Diamondback® HD 8x42

BEST: Viper® HD 8x42



## LONG-RANGE SHOOTING

Shooters are stretching their effective range farther than ever. The right binocular helps identify corrections and helps squeeze the most performance out of your long-range rig.

15x  
18x

### MAGNIFICATION

High-powered magnification makes it easier to spot impacts and make corrections. Get on target faster with plenty of optical horsepower for the job.

### OBJECTIVE SIZE

Magnification trumps weight in the long-range game. Higher magnification increases clarity at distance for superior target detail.

### OPTICS

Impacts on steel targets aren't easy to identify. All else equal, a superior optical system provides better resolution for accurately spotting impacts or calling adjustments at distance.

### OUR BINOCULAR RECOMMENDATION:

GOOD: Diamondback® HD 15x56

BETTER: Kaibab® HD 18x56

BEST: Razor® UHD 18x56

Note – When using a binocular over 12x it is highly recommended using a tripod for stabilization.



RAZOR® UHD



A NEW ERA OF  
observation.

VORTEXOPTICS.COM

# RAZOR<sup>®</sup> UHD

FULL-SIZE ABBE-KOENIG PRISM BINOCULARS



**BINO PACK  
INCLUDED**

## A NEW ERA OF OBSERVATION.

When it comes to serious glassing, the details are what matters most, and with the Razor<sup>®</sup> UHD you won't miss a thing. Built lens-to-lens for those who demand the best in each component, the Razor<sup>®</sup> UHD provides exceptional optical quality and color fidelity. An optical system built around an Abbe-Koenig prism means better light transmission, while advanced lens coatings conquer low-light situations. The larger prism provides better image resolution whether looking near or far. See more with the Razor<sup>®</sup> UHD.



SKU	MAGNIFICATION X OBJECTIVE LENS DIAMETER	LINEAR FIELD OF VIEW (@ 1000 YARDS)	ANGULAR FIELD OF VIEW	CLOSE FOCUS	EYE RELIEF	INTERPUPILLARY DISTANCE	HEIGHT	WIDTH	WEIGHT
RZB-3104	18x56	194'	3.7°	10.0'	18.0mm	56mm - 76mm	8.4"	6.2"	42.0 oz.
RZB-3103	12x50	288'	5.5°	6.6'	17.0mm	56mm - 76mm	7.6"	5.9"	36.5 oz.
<b>NEW</b> RZB-3105	10x50	341'	6.5°	6.6'	18.0mm	56mm - 76mm	7.6"	5.9"	36.5 oz.
RZB-3102	10x42	346'	6.6°	4.5'	16.7mm	56mm - 76mm	7.0"	5.7"	32.4 oz.
RZB-3101	8x42	420'	8.0°	4.5'	16.7mm	56mm - 76mm	7.0"	5.7"	32.4 oz.

- ### FEATURES
- ▶ UHD OPTICAL SYSTEM
  - ▶ XR™ PLUS LENS COATINGS
  - ▶ PLASMA TECH
  - ▶ PHASE CORRECTION
  - ▶ APOCHROMATIC
  - ▶ ARMORTEK<sup>®</sup>
  - ▶ RUBBER ARMOR
  - ▶ ARGON GAS PURGED
  - ▶ WATERPROOF
  - ▶ FOGPROOF
  - ▶ SHOCKPROOF
  - ▶ TRIPOD ADAPTABLE

For a description of each feature, see page 132.





# YOUR HIDE-AND-SEEK cheat code.



RAZOR® HD

VORTEXOPTICS.COM



# RAZOR<sup>®</sup> HD

FULL-SIZE ROOF PRISM BINOCULARS



## YOUR HIDE-AND-SEEK CHEAT CODE.

Small, light, bright, and strong, with all the magnification ranges you need to work wild places coast to coast. Incredibly clear HD glass, and a rock-solid build that won't weigh you down, make this the perfect bino to trust on a day hike, and the hunt of a lifetime.



SKU	MAGNIFICATION X OBJECTIVE LENS DIAMETER	LINEAR FIELD OF VIEW (@ 1000 YARDS)	ANGULAR FIELD OF VIEW	CLOSE FOCUS	EYE RELIEF	INTERPUPILLARY DISTANCE	HEIGHT	WIDTH	WEIGHT
RZB-2104	12x50	285'	5.4°	10.0'	15.5mm	57mm - 74mm	6.8"	5.1"	28.7 oz.
RZB-2103	10x50	315'	6.0°	10.0'	16.5mm	57mm - 74mm	6.8"	5.1"	28.1 oz.
RZB-2102	10x42	362'	6.9°	6.0'	16.5mm	55mm - 75mm	5.9"	5.1"	24.8 oz.
RZB-2101	8x42	388'	7.4°	6.0'	17.5mm	55mm - 75mm	5.9"	5.1"	24.2 oz.

- ### FEATURES
- ▶ HD OPTICAL SYSTEM
  - ▶ XR™ PLUS LENS COATINGS
  - ▶ DIELECTRIC PRISM COATINGS
  - ▶ PLASMA TECH
  - ▶ PHASE CORRECTION
  - ▶ APOCHROMATIC
  - ▶ ARMORTEK®
  - ▶ RUBBER ARMOR
  - ▶ ARGON GAS PURGED
  - ▶ WATERPROOF
  - ▶ FOGPROOF
  - ▶ SHOCKPROOF
  - ▶ TRIPOD ADAPTABLE

For a description of each feature, see page 132.





KALBAB® HD



THE POWER TO  
move mountains.

VORTEXOPTICS.COM

# KAIBAB® HD

FULL-SIZE ROOF PRISM BINOCULARS



## THE POWER TO MOVE MOUNTAINS.

The key ingredients for a successful big-game stalk? Patience, perseverance, and the kind of optical reach you'll find in the Kaibab® HD. The superior viewing experience of binoculars, but with the power you need for long-distance glassing, the Kaibab® HD delivers the premium, high-magnification optical performance it takes to give your dream hunt a happy ending. Heads up: These high performing, high power binoculars are intended to be used with a tripod for extended, comfortable, steady viewing.

Note – Recommended for use with a tripod. Tripod adapter included.

SKU	MAGNIFICATION X OBJECTIVE LENS DIAMETER	LINEAR FIELD OF VIEW (@ 1000 YARDS)	ANGULAR FIELD OF VIEW	CLOSE FOCUS	EYE RELIEF	INTERPUPILLARY DISTANCE	HEIGHT	WIDTH	WEIGHT
KAI-5618	18x56	194'	3.7°	19.8'	16.4mm	60mm - 76mm	7.7"	5.7"	43.5 oz.

### FEATURES

- ▶ HD OPTICAL SYSTEM
- ▶ XR™ LENS PLUS COATINGS
- ▶ DIELECTRIC PRISM COATINGS
- ▶ PLASMA TECH
- ▶ PHASE CORRECTION
- ▶ APOCHROMATIC
- ▶ ARMORTEK®
- ▶ RUBBER ARMOR
- ▶ ARGON GAS PURGED
- ▶ WATERPROOF
- ▶ FOGPROOF
- ▶ SHOCKPROOF
- ▶ TRIPOD ADAPTABLE

For a description of each feature, see page 132.





VIPER® HD



**BUILT TO CARRY  
WHERE OTHERS  
fear to tread.**

VORTEXOPTICS.COM

# VIPER<sup>®</sup> HD

FULL-SIZE ROOF PRISM BINOCULARS



GLASSPAK<sup>™</sup>  
INCLUDED

## BUILT TO CARRY WHERE OTHERS FEAR TO TREAD.

Viper<sup>®</sup> HD binoculars are an optical masterpiece, giving hunters, shooters, and outdoor enthusiasts a premium option without the premium price tag. The HD optical system delivers stunning resolution, brilliant color fidelity, and edge-to-edge clarity. These are one of the lightest, most compact, full-size binos on the market — no small thing on hunts and excursions where every ounce matters. Reach for the Viper<sup>®</sup> HD when you need to pack light without sacrificing performance.



SKU	MAGNIFICATION X OBJECTIVE LENS DIAMETER	LINEAR FIELD OF VIEW (@ 1000 YARDS)	ANGULAR FIELD OF VIEW	CLOSE FOCUS	EYE RELIEF	INTERPUPILLARY DISTANCE	HEIGHT	WIDTH	WEIGHT
V203	12x50	288'	5.5°	8.0'	16.0mm	59mm - 75mm	6.5"	5.2"	28.8 oz.
V202	10x50	346'	6.6°	8.0'	16.0mm	59mm - 75mm	6.5"	5.2"	28.4 oz.
V201	10x42	341'	6.5°	6.0'	17.0mm	55mm - 74mm	5.6"	4.9"	24.9 oz.
V200	8x42	409'	7.8°	6.0'	18.0mm	55mm - 74mm	5.6"	4.9"	24.5 oz.

### FEATURES

- ▶ HD OPTICAL SYSTEM
- ▶ XR<sup>™</sup> LENS COATINGS
- ▶ DIELECTRIC PRISM COATINGS
- ▶ PHASE CORRECTION
- ▶ ARMORTEK<sup>®</sup>
- ▶ RUBBER ARMOR
- ▶ ARGON GAS PURGED
- ▶ WATERPROOF
- ▶ FOGPROOF
- ▶ SHOCKPROOF
- ▶ TRIPOD ADAPTABLE

For a description of each feature, see page 132.





# DIAMONDBACK<sup>®</sup> HD

FULL / MID / COMPACT-SIZE ROOF PRISM BINOCULARS



GLASSPAK<sup>™</sup>  
INCLUDED

\*Select Models Only

## EXPERIENCE LOVE AT FIRST SIGHT.

Take a binocular that broke all the rules about performance at its price point. Add an HD optical system to give it even more clarity. The result? The Diamondback<sup>®</sup> HD, an astoundingly efficient and high-performing bino with enhanced, dielectric, fully multi-coated lenses serving up impressive low-light performance — critical when glassing and evaluating game. Plus, we're now including the GlassPak<sup>™</sup> binocular harness so your binos are always at the ready.



SKU	MAGNIFICATION X OBJECTIVE LENS DIAMETER	LINEAR FIELD OF VIEW (@ 1000 YARDS)	ANGULAR FIELD OF VIEW	CLOSE FOCUS	EYE RELIEF	INTERPUPILLARY DISTANCE	HEIGHT	WIDTH	WEIGHT
DB-218	15x56	230'	4.4°	14.0'	15.6mm	59mm - 76mm	7.1"	5.8"	34.8 oz.
DB-217	12x50	271'	5.2°	6.0'	14.0mm	60mm - 75mm	6.4"	5.3"	28.9 oz.
DB-216	10x50	315'	6.0°	6.0'	17.0mm	60mm - 75mm	6.6"	5.3"	30.0 oz.
DB-215	10x42	330'	6.3°	5.0'	15.0mm	55mm - 73mm	5.7"	5.1"	21.3 oz.
DB-214	8x42	393'	7.5°	5.0'	17.0mm	55mm - 73mm	5.7"	5.1"	21.8 oz.
DB-213	10x32	340'	6.5°	6.0'	14.0mm	57mm - 73mm	4.4"	5.0"	16.0 oz.
DB-212	8x32	426'	8.1°	5.0'	16.0mm	57mm - 73mm	4.4"	5.0"	15.9 oz.
DB-211	10x28	273'	5.1°	6.0'	16.0mm	55mm - 72mm	4.6"	4.6"	13.3 oz.
DB-210	8x28	332'	6.2°	6.0'	18.0mm	55mm - 72mm	4.6"	4.5"	13.7 oz.

### FEATURES

- ▶ HD OPTICAL SYSTEM
- ▶ FULLY MULTI-COATED LENSES
- ▶ DIELECTRIC PRISM COATINGS
- ▶ PHASE CORRECTION
- ▶ ARMORTEK<sup>®</sup>
- ▶ RUBBER ARMOR
- ▶ ARGON GAS PURGED
- ▶ WATERPROOF
- ▶ FOGPROOF
- ▶ SHOCKPROOF
- ▶ TRIPOD ADAPTABLE

For a description of each feature, see page 132.



# CROSSFIRE® HD

FULL-SIZE ROOF PRISM BINOCULARS



GLASSPAK™  
INCLUDED

## MORE COLOR. MORE FIDELITY. MORE FILLED TAGS.

The Crossfire® HD binocular lineup combines an HD optical system with best-in-class value and performance. Optimized glass elements and included GlassPak™ binocular harness make the Crossfire® HD binoculars hunt ready. An affordable price point means you'll have a healthy budget set aside to pay your taxidermy bill.



SKU	MAGNIFICATION X OBJECTIVE LENS DIAMETER	LINEAR FIELD OF VIEW (@ 1000 YARDS)	ANGULAR FIELD OF VIEW	CLOSE FOCUS	EYE RELIEF	INTERPUPILLARY DISTANCE	HEIGHT	WIDTH	WEIGHT
CF-4314	12x50	273'	5.2°	6.0'	15.0mm	60mm - 76mm	6.6"	5.3"	29.5 oz.
CF-4313	10x50	320'	6.1°	6.0'	17.0mm	60mm - 76mm	6.7"	5.3"	30.4 oz.
CF-4312	10x42	325'	6.2°	6.0'	15.0mm	58mm - 75mm	6.0"	5.2"	23.0 oz.
CF-4311	8x42	393'	7.5°	6.0'	17.0mm	58mm - 75mm	6.2"	5.2"	23.8 oz.

### FEATURES

- ▶ HD OPTICAL SYSTEM
- ▶ FULLY MULTI-COATED LENSES
- ▶ RUBBER ARMOR
- ▶ NITROGEN GAS PURGED
- ▶ WATERPROOF
- ▶ FOGPROOF
- ▶ SHOCKPROOF
- ▶ TRIPOD ADAPTABLE

For a description of each feature, see page 132.





# RAPTOR™

MID-SIZE PORRO PRISM BINOCULARS



RAPTOR™ / VANQUISH®

## RECONNECT WITH YOUR WILD SIDE.

A classic look, updated with high-quality glass, makes for one fantastic, affordable optic. Porro prism performance in a mid-size, wide-angle design, Raptor™ binoculars offer bright, crisp images with excellent color fidelity, even in low-light conditions. Plus, the design accommodates a wide range of interpupillary distances to fit everyone in the family.

SKU	MAGNIFICATION X OBJECTIVE LENS DIAMETER	LINEAR FIELD OF VIEW (@ 1000 YARDS)	ANGULAR FIELD OF VIEW	CLOSE FOCUS	EYE RELIEF	INTERPUPILLARY DISTANCE	HEIGHT	WIDTH	WEIGHT
R310	10x32	339'	6.3°	15.0'	13.0mm	50mm - 70mm	5.1"	6.2"	19.0 oz.
R385	8.5x32	390'	7.4°	15.0'	14.0mm	50mm - 70mm	5.0"	6.2"	18.7 oz.

### FEATURES

- ▶ SD OPTICAL SYSTEM
- ▶ FULLY MULTI-COATED LENSES
- ▶ RUBBER ARMOR
- ▶ NITROGEN GAS PURGED
- ▶ WATERPROOF
- ▶ FOGPROOF
- ▶ SHOCKPROOF

For a description of each feature, see page 132.





# VANQUISH®

COMPACT REVERSE PORRO PRISM BINOCULARS



## SMALL WONDER.

The Vanquish® is proof positive you can pack an awful lot of innovation into a small package. The reverse porro prism design uses high quality glass and fully multi-coated optics to render crisp, bright images with a wide field of view that makes quick work of scanning any landscape. Weighing in at just 12.7 ounces and affordably priced, this compact performer will earn a place in your pack.

SKU	MAGNIFICATION X OBJECTIVE LENS DIAMETER	LINEAR FIELD OF VIEW (@ 1000 YARDS)	ANGULAR FIELD OF VIEW	CLOSE FOCUS	EYE RELIEF	INTERPUPILLARY DISTANCE	HEIGHT	WIDTH	WEIGHT
VNQ-1026	10x26	294'	5.6°	7.6'	16.0mm	57mm - 71mm	4.3"	4.6"	12.7 oz.
VNQ-0826	8x26	352'	6.7°	7.6'	15.0mm	57mm - 71mm	4.3"	4.6"	12.7 oz.

### FEATURES

- ▶ SD OPTICAL SYSTEM
- ▶ FULLY MULTI-COATED LENSES
- ▶ RUBBER ARMOR
- ▶ NITROGEN GAS PURGED
- ▶ WATERPROOF
- ▶ FOGPROOF
- ▶ SHOCKPROOF

For a description of each feature, see page 132.





# BINOCULAR accessories



### GLASSPAK™ BINOCULAR HARNESS

P400

Protecting your binos from the elements while keeping them close at hand is imperative in the field, and the Vortex® GlassPak™ binocular harness accommodates a range of full-size binoculars, keeping them snug and secure. The mesh side pockets hold calls, a lens pen, and other small items for quick access. Tethers attach to your binocular preventing accidental drops, and the rear zippered pocket holds larger items, such as a cell phone.



### GUIDE BINOPACK

P300

Protect your binoculars, keep the lenses clean, and carry essential gear with the Guide BinoPack. An integrated bino leash prevents drops and lets you lower your binoculars with confidence. A generous, front zippered pouch with shell loops is perfect for larger items such as rangefinders, a knife, fire starters, and whatever else you need at your fingertips. The side pockets, zippered pocket on the rear face, and elastic sleeves on the top hold additional items.



## BINOCULAR HARNESS

VTHARNESS

Say goodbye to neck strain and keep your binoculars still while you walk the trail. This comfortable strap keeps bins, rangefinders, and even cameras from jostling around as you move, leaving your hands free.



## ARCHER'S BINOCULAR STRAP

ARCH

Comfort and simplicity, that's what you need to keep your bins close for when you need them, and out of the way when it's time to take your shot. The Archer's Binocular Strap is built to last, and to keep you comfortable, so you can focus on the hunt.



## SPORT BINOCULAR ADAPTER

TRA-BINDAP2

When you need stability and control, the Vortex® Sport Binocular Adapter is precision machined and fits any tripod-adaptable binocular. Its slim profile fits between the barrels of the largest high-powered binoculars, and a lift-off connector means the binocular can be removed for hand-held use without disconnecting the entire adapter.



## PRO BINOCULAR ADAPTER

TRA-BINDAP

A two-part system that creates one seamless glassing experience, the Pro Binocular Adapter combines an incredibly sleek form factor with a fast, stable mount to keep you on the move. It installs quickly and it's simple to operate. Aluminum construction means lightweight durability, and 1/4"-20 thread compatibility means it fits seamlessly with tripod adaptable binoculars and plates.



## 2X DOUBLER

2X

Sometimes, every ounce counts, but you still need to reach farther than your binos alone allow. This handy tool is super lightweight and doubles the magnification of most 32mm or larger binoculars, and the Recon® monocular, to take in more details.





# TIPS FROM THE PROS



SCAN THE CODE TO READ THE FULL BLOG POSTS

It doesn't matter if you're heading to the mountains to chase elk, or to the range to work some pistol drills, there's no better weapon than know-how. No matter how or why you shoot, the Vortex® blog offers topics to satisfy your curiosity and make you a more complete shooter.

**Know more. Shoot better. Read up.**



## MASTERING THE SPLASH CALL – REMI WARREN

As hunters, we're always looking for that extra edge or bit of information to help us find success in the field. Heck, that's half the fun. Add this off-the-wall tactic courtesy of Remi Warren to your elk hunting repertoire and you may be rewarded with a big bull right in your lap.

Scan the QR code to read the full blog post.



## BIRD DOG TRAINING FUNDAMENTALS – FOWL LIFE® TV

Do you have a pup prime to be a future gun dog? Here are ten tips from Chad Belding (The Fowl Life® TV) and Brad Arington (Mossy Pond Retrievers) to get it there.

Scan the QR code to read the full blog post.



### HOW TO PREPARE FOR YOUR FIRST COMPETITIVE SHOOTING MATCH – CHRIS URRUTIA, VORTEX OPTICS

Whether winning means climbing the podium or just having a great time, competition season is a sure way to get your blood pumping. If you want to make sure you're ready when you hear "shooter ready?" we've got the tips, tricks, and advice to get in shooting shape this season.

Scan the QR code to read the full blog post.



### MAKE YOUR RIFLE FIT YOU – MARK BOARDMAN, VORTEX OPTICS

Rifle fit is paramount for accuracy and a positive shooting experience. The less you force and think about during the shooting process, the better you focus on the fundamentals of marksmanship, executing the most accurate shot possible. Refining fit variables to make your firearm an extension of your body, not something you have to fight, will make you a better shooter.

Scan the QR code to read the full blog post.



### 90 DAYS TO A BETTER WESTERN HUNT – DAN STATON

Congratulations, you're heading out west and adventure awaits you. If getting into shape has not been high on the priority list for you, GREAT NEWS, it's not too late.

Scan the QR code to read the full blog post.



# rangefinders



# RANGEFINDERS

## COMPARISON CHART



	FURY® HD 5000 AB	FURY® HD 5000	RAZOR® HD 4000	RANGER® 1800	IMPACT® 1000
<b>Intended Use</b>	Long-Range Western Hunting, Precision Shooting	Long-Range Western Hunting	Long-Range Western Hunting	Great Plains Hunting, Midwestern Hunting	Eastern and Midwest Hunting
<b>Configuration</b>	10x42	10x42	7x25	6x22	6x20
<b>Max. Reflective Range</b>	Up to 5,000 yds.	Up to 5,000 yds.	Up to 4,000 yds.	Up to 1,800 yds.	Up to 1,000 yds.
<b>Tree Range</b>	Up to 2,400 yds.	Up to 2,400 yds.	Up to 2,500 yds.	Up to 1,000 yds.	Up to 800 yds.
<b>Deer Range</b>	Up to 1,600 yds.	Up to 1,600 yds.	Up to 2,200 yds.	Up to 900 yds.	Up to 500 yds.
<b>Accuracy</b>	+/- 1 yd.	+/- 1 yd.	+/- 1 yd.	+/- 1 yd.	+/- 1 yd.
<b>Display Type</b>	Red OLED	Red OLED	Red Backlit LCD	Red OLED	Black LCD
<b>Range Modes</b>	BAL, HCD, Scan	LOS, HCD, Scan	LOS, HCD, Scan	LOS, HCD, Scan	LOS, HCD, Scan
<b>Target Modes</b>	Best, Last	Best, Last	Normal, First, Last, ELR	Normal	Normal
<b>Key Features</b>	<ul style="list-style-type: none"> <li>• In-Display Wind/Drop Solutions</li> <li>• Customize Ballistic Profiles</li> <li>• On-Board Profiles</li> <li>• On-Board Environmental Sensors</li> <li>• Two Wind Modes</li> <li>• Pairs with Third Party Devices</li> <li>• GlassPak™ Binocular Harness &amp; Case</li> <li>• Tripod Adaptable</li> </ul>	<ul style="list-style-type: none"> <li>• GlassPak™ Binocular Harness</li> <li>• Adjustable Eyecups</li> <li>• Tethered Lens Covers</li> <li>• Neck Strap</li> <li>• Tripod Adaptable</li> </ul>	<ul style="list-style-type: none"> <li>• Magnesium Chassis</li> <li>• Premium Carry Case</li> <li>• Utility Clip</li> <li>• Tripod Adaptable</li> </ul>	<ul style="list-style-type: none"> <li>• Utility Clip</li> <li>• Soft Carry Case</li> <li>• Tripod Adaptable</li> </ul>	<ul style="list-style-type: none"> <li>• Soft Carry Case</li> </ul>

# FURY® HD 5000 AB

LASER RANGEFINDING BINOCULARS

FURY® HD 5000 AB / FURY® HD 5000



ON-BOARD ENVIRONMENTAL SENSORS

TWO WIND MODES  
MANUALLY ENTER SPEED AND DIRECTION



IN DISPLAY WIND/DROP SOLUTIONS

PAIR WITH KESTREL®  
\*SOLD SEPARATELY

CUSTOMIZE BALLISTIC PROFILES WITH FURY HD APP

GLASSPAK™ INCLUDED

## ELIMINATE THE UNKNOWN.

Carrying your bins and rangefinder in one package is smart. The next generation Fury® HD 5000 AB is smarter. This rangefinding binocular takes the guess work out of dialing long-range shots with in-display ballistic data and built-in environmental sensors, which means less time calculating ballistics and more time putting rounds down range. With the Applied Ballistics® Elite solver built right in, you can pair with the Fury HD App to create custom ballistic profiles, and with popular Kestrel® and Applied Ballistics® Garmin® devices for ultimate, real-time precision. Put simply, it's the smartest way to shoot.



- RANGING MODES**
- HORIZONTAL COMPONENT DISTANCE (HCD)**  
Angle compensated distance to target.
  - LINE OF SIGHT (LOS)**  
Actual line of sight range.
  - SCAN**  
Displays continuous distance readings when panning.
- TARGET MODES**
- BEST MODE**  
Displays strongest returned range.
  - LAST MODE**  
Displays furthest returned range.

## FEATURES

- ▶ HD OPTICAL SYSTEM
- ▶ XR™ LENS COATINGS
- ▶ DIELECTRIC PRISM COATINGS
- ▶ PHASE CORRECTION
- ▶ ARMORTEK®
- ▶ RUBBER ARMOR
- ▶ NITROGEN GAS PURGED
- ▶ WATERPROOF
- ▶ FOGPROOF
- ▶ SHOCKPROOF
- ▶ TRIPOD ADAPTABLE

SKU	MAGNIFICATION X OBJECTIVE LENS DIAMETER	LINEAR FIELD OF VIEW (@ 1000 YARDS)	ANGULAR FIELD OF VIEW	CLOSE FOCUS	EYE RELIEF	INTERPUPILLARY DISTANCE	MAX. REFLECTIVE RANGE (UP TO)	TREE RANGE (UP TO)	DEER RANGE (UP TO)	MIN. RANGE	HEIGHT	WIDTH	WEIGHT
LRF302	10x42	321'	6.1°	18.5'	16.0mm	58mm - 72mm	5000 yds.	2400 yds.	1600 yds.	5 yds.	5.8"	5.0"	32.4 oz.

For a description of each feature, see page 132.



VORTEXOPTICS.COM



# FURY<sup>®</sup> HD 5000

LASER RANGEFINDING BINOCULARS



## SIMPLIFY. MAGNIFY.

One trip into the backcountry with a heavy pack and you realize the less you have to carry, the better. The Fury<sup>®</sup> HD 5000 rangefinding binoculars combine two of the most important pieces of hunting gear into one powerful, long-ranging unit, making glassing and ranging ultra-fast and efficient. Right-side button controls make one-handed manipulation of both functions quick and easy, cutting down on set up time in the field.



### RANGING MODES

#### HORIZONTAL COMPONENT DISTANCE (HCD)

Angle compensated distance to target.

#### LINE OF SIGHT (LOS)

Actual line of sight range.

#### SCAN

Displays continuous distance readings when panning.

### TARGET MODES

#### BEST MODE

Displays strongest returned range.

#### LAST MODE

Displays furthest returned range.

### FEATURES

- ▶ HD OPTICAL SYSTEM
- ▶ XR™ LENS COATINGS
- ▶ DIELECTRIC PRISM COATINGS
- ▶ PHASE CORRECTION
- ▶ ARMORTEX<sup>®</sup>
- ▶ RUBBER ARMOR
- ▶ NITROGEN GAS PURGED
- ▶ WATERPROOF
- ▶ FOGPROOF
- ▶ SHOCKPROOF
- ▶ TRIPOD ADAPTABLE

SKU	MAGNIFICATION X OBJECTIVE LENS DIAMETER	LINEAR FIELD OF VIEW (@ 1000 YARDS)	ANGULAR FIELD OF VIEW	CLOSE FOCUS	EYE RELIEF	INTERPUPILLARY DISTANCE	MAX. REFLECTIVE RANGE (UP TO)	TREE RANGE (UP TO)	DEER RANGE (UP TO)	MIN. RANGE	HEIGHT	WIDTH	WEIGHT
LRF301	10x42	321'	6.1°	18.5'	16.0mm	58mm - 72mm	5000 yds.	2400 yds.	1600 yds.	5 yds.	5.8"	5.0"	32.3 oz.

For a description of each feature, see page 132.





RAZOR® HD 4000



GO THE DISTANCE.  
then range it.

VORTEXOPTICS.COM

# RAZOR® HD 4000

LASER RANGEFINDER



## GO THE DISTANCE. THEN RANGE IT.

When “as far as the eye can see” isn’t good enough, you need the Razor® HD 4000. The definition of what a high-end, long-range laser rangefinder should be, the Razor® HD 4000 delivers cutting-edge optical and ranging performance, giving hunters and shooters the data needed to execute even the most demanding shots. This extremely effective, angle-compensated rangefinder features four targeting modes and two ranging modes to cover any environment. Impressive 4,000 yard reflective ranging capability (ELR mode) reaches way out for extreme precision. A utility clip keeps these compact units close at hand, and each model is easily mounted to any 1/4”-20 tripod plate when you need a rock-steady base.



### RANGING MODES

#### HORIZONTAL COMPONENT DISTANCE (HCD)

Angle compensated distance to target.

#### LINE OF SIGHT (LOS)

Actual line of sight range.

#### SCAN

Displays continuous distance readings when panning.

### TARGET MODES

#### EXTENDED LASER RANGE (ELR)

Displays precise returned range.

#### BEST MODE

Displays strongest returned range.

#### LAST MODE

Displays furthest returned range.

#### FIRST MODE

Displays closest returned range.

### FEATURES

- ▶ HD OPTICAL SYSTEM
- ▶ XR™ PLUS LENS COATINGS
- ▶ DIELECTRIC PRISM COATINGS
- ▶ ARMORTEK®
- ▶ RUBBER ARMOR
- ▶ WATERPROOF
- ▶ SHOCKPROOF
- ▶ TRIPOD ADAPTABLE

SKU	MAGNIFICATION	OBJECTIVE LENS DIAMETER	MAX. REFLECTIVE RANGE (UP TO)	TREE RANGE (UP TO)	DEER RANGE (UP TO)	MIN. RANGE	LINEAR FIELD OF VIEW (@ 1000 YARDS)	ANGULAR FIELD OF VIEW	EYE RELIEF	LENGTH	HEIGHT	WIDTH	WEIGHT
LRF-250	7x	25mm	4000 yds.	2500 yds.	2200 yds.	5 yds.	341'	6.5°	19mm	4.3"	3.1"	1.7"	9.9 oz.

For a description of each feature, see page 132.



# RANGER® 1800

LASER RANGEFINDER



## HOME ON THE RANGE.

Besides being easy to use, the Ranger® bucks the trend of overly complicated electronics that end up being useless in the field. The built-in angle compensation is popular with treestand hunters looking to get exact horizontal distance to a deer, and long-range shooters who need to calculate complex ballistic solutions using precise data. An illuminated display keeps you ranging at first and last light, and a utility clip keeps these compact units close at hand. The Ranger® is easily mounted to any 1/4"-20 tripod plate when you need a rock-steady base.



### RANGING MODES

**HORIZONTAL COMPONENT DISTANCE (HCD)**  
Angle compensated distance to target.

**LINE OF SIGHT (LOS)**  
Actual line of sight range.

**SCAN**  
Displays continuous distance readings when panning.

### FEATURES

- ▶ FULLY MULTI-COATED LENSES
- ▶ RUBBER ARMOR
- ▶ WATERPROOF
- ▶ SHOCKPROOF
- ▶ TRIPOD ADAPTABLE

SKU	MAGNIFICATION	OBJECTIVE LENS DIAMETER	MAX. REFLECTIVE RANGE (UP TO)	TREE RANGE (UP TO)	DEER RANGE (UP TO)	MIN. RANGE	LINEAR FIELD OF VIEW (@ 1000 YARDS)	ANGULAR FIELD OF VIEW	EYE RELIEF	LENGTH	HEIGHT	WIDTH	WEIGHT
RRF-181	6x	22mm	1800 yds.	1000 yds.	900 yds.	10 yds.	315'	6.0°	17mm	3.9"	3.0"	1.6"	7.7 oz.

For a description of each feature, see page 132.



# IMPACT® 1000

LASER RANGEFINDER



RANGE IN YARDS  
OR METERS

INTUITIVE BLACK  
LCD DISPLAY

## SPOT. RANGE. SHOOT... IMPACT.

Simply put, the Impact® rangefinder's combination of excellent, reliable performance at a super-economical price means you no longer have an excuse to head out without a laser rangefinder. This lightweight, no-frills rangefinder features angle compensation for treestand hunters and casual range goers wanting precise, horizontal distance to the target. And with a max reflective distance of 1000 yards, you'll have all the reach you need.



### RANGING MODES

**HORIZONTAL COMPONENT DISTANCE (HCD)**  
Angle compensated distance to target.

**LINE OF SIGHT (LOS)**  
Actual line of sight range.

**SCAN**  
Displays continuous distance readings when panning.

SKU	MAGNIFICATION	OBJECTIVE LENS DIAMETER	MAX. REFLECTIVE RANGE (UP TO)	TREE RANGE (UP TO)	DEER RANGE (UP TO)	MIN. RANGE	LINEAR FIELD OF VIEW (@ 1000 YARDS)	ANGULAR FIELD OF VIEW	EYE RELIEF	LENGTH	HEIGHT	WIDTH	WEIGHT
LRF101	6x	20mm	1000 yds.	800 yds.	500 yds.	5 yds.	341'	6.5°	15mm	3.8"	3.0"	1.4"	5.5 oz.

### FEATURES

- ▶ FULLY MULTI-COATED LENSES
- ▶ WATERPROOF
- ▶ SHOCKPROOF

For a description of each feature, see page 132.





VIP WARRANTY

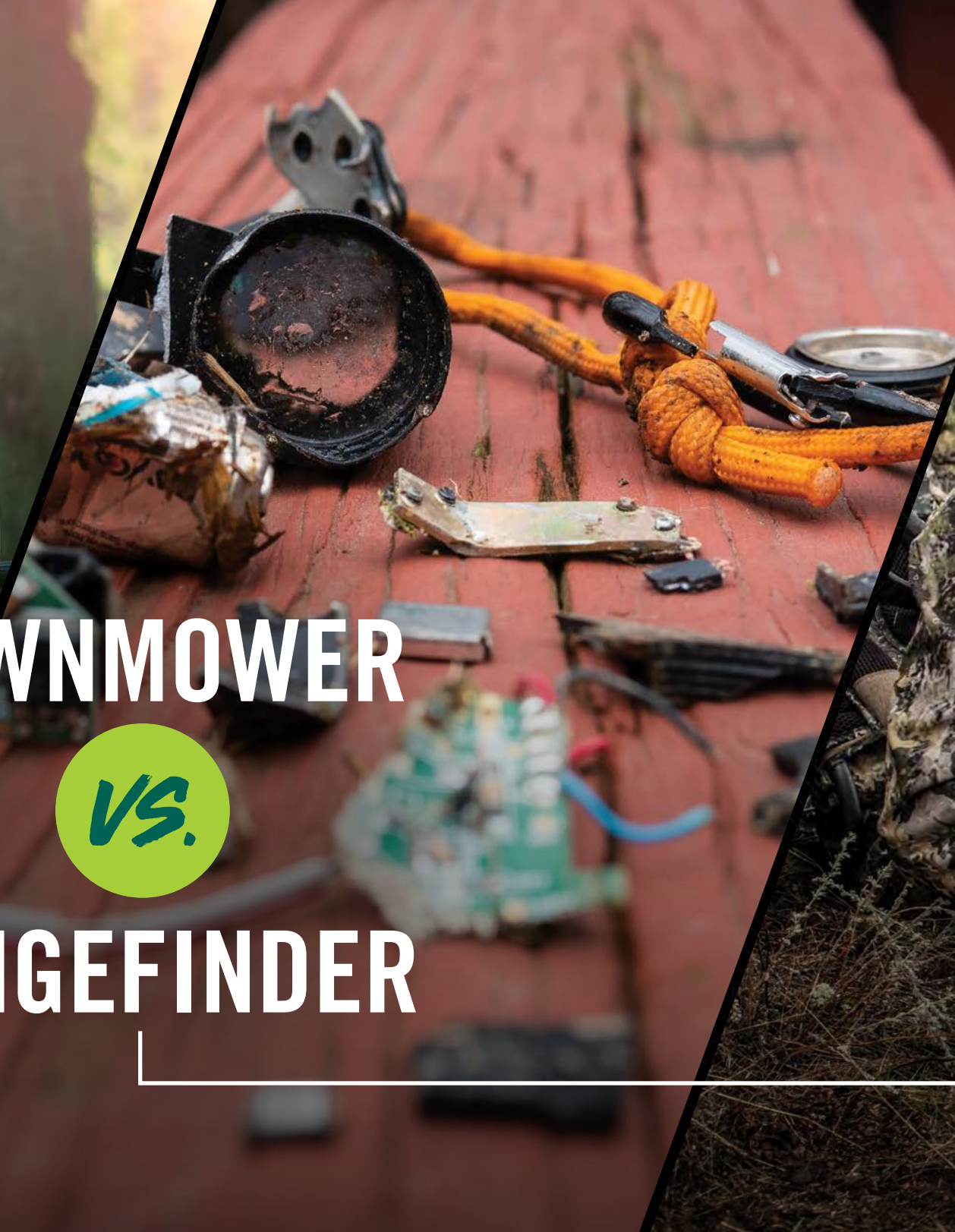

LAWN MOWER

VS.

RANGEFINDER

VORTEXOPTICS.COM



**UNLIMITED.  
UNCONDITIONAL.  
LIFETIME WARRANTY.**

**COVERED.**

“

I'm killing some time at my home office shooting my bow in my backyard. As I'm flinging arrows, I keep moving around to various spots and checking my site tape on my moveable site, so I'm carrying my rangefinder with me to verify the distance before I let an arrow fly. I toss the rangefinder on the ground after I verify the distance, and then shoot some arrows...

I completely forget that I'm a couple minutes late for a conference call, and I rush inside to hop on the call. As I'm sitting in my home office on my call, I look outside and see my lawn crew driving around my yard and at first think nothing of it... then I remember my rangefinder is laying on the ground still outside and have a mild panic attack. By the time I got there, the rangefinder was gone. I looked on the ground to see a shiny little rock, which turned out to be a motherboard piece the size of a match head. This resulted in a scavenger hunt over the next couple hours, picking up pieces of the rangefinder. I was absolutely amazed that after a quick call to Vortex, they told me 'No worries! Just pick up a couple pieces and send it on in.'

It's amazing that the Vortex warranty will cover 100% stupidity, that was fully my fault, and replace it no questions asked! ”

**-TAYLOR C.**

Vortex® will repair or replace the product. Absolutely free—no matter the cause. Does not cover loss, theft, deliberate damage, or cosmetic damage that does not hinder the performance of the product.



# VORTEX OPTICS YOUTUBE CHANNEL

106K SUBSCRIBERS

[SUBSCRIBE](#)

- [HOME](#)
- [VIDEOS](#)
- [PLAYLISTS](#)
- [COMMUNITY](#)
- [CHANNELS](#)
- [ABOUT](#)
- [🔍](#)

Rethink the limits of what's possible. There's no shortage of noise in today's digital space, and your time has never been more valuable. You deserve to be educated, entertained, and inspired. Shoot far, explore deeper, and arm yourself with the information you need to become the most capable version of yourself. Whether you're yearning to learn more about the world of hunting and shooting, or just need a good laugh, you've found your home on the Vortex Optics YouTube channel.







Go Long-Range at the Vortex® Vengeance



Desert Dreams – Bighorns in Mexico



How to Sight in a Red Dot on Your Pistol



How to Sight in a Riflescope

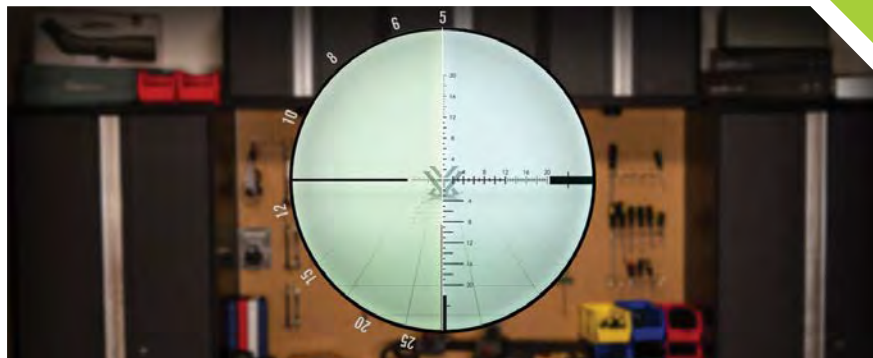

First Focal Plane vs. Second Focal Plane



Fall is Here – The Anniversary



# monoculars



# MONOCULARS

## COMPARISON CHART



	RECON® R/T	RECCE PRO® HD	SOLO® R/T	SOLO®
<b>Intended Use</b>	Long-Range, Scouting / Ranging	Scouting / Ranging	Scouting / Ranging	Game Scouting, General Recreation
<b>Configurations</b>	15x50	8x32	8x36	8x25 8x36 10x25 10x36
<b>Reticle</b>	MRAD Ranging Reticle	MRAD Ranging Reticle	MRAD Ranging Reticle	N/A

# RECON<sup>®</sup> R/T

MONOCULAR



RECON<sup>®</sup> R/T / RECCE PRO<sup>®</sup> HD



## POCKET SIZED SPOTTING SCOPE.

The Recon<sup>®</sup> R/T is an advanced tactical monocular unlike any other in the field: It's the first truly compact, full-featured monocular in the Vortex<sup>®</sup> line developed specially for field surveillance and range estimation with MRAD-based subtensions and secondary quick ranging silhouettes. The versatile attachment clip secures the Recon<sup>®</sup> R/T to any belt or strap, so it's ready at a moment's notice.

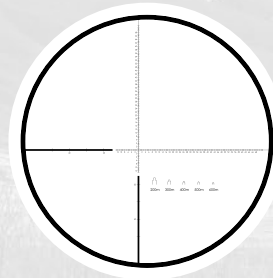

### R/T RANGING RETICLE

Uses MRAD-based subtensions and includes silhouettes for quick ranging. The angular measurements allow you to calculate ranges when comparing the reticle to objects of known dimension.

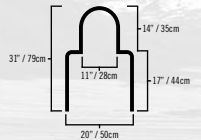

### FEATURES

- ▶ XD™ OPTICAL SYSTEM
- ▶ XR™ LENS COATINGS
- ▶ ARMORTEK<sup>®</sup>
- ▶ RUBBER ARMOR
- ▶ ARGON GAS PURGED
- ▶ PHASE CORRECTION
- ▶ WATERPROOF
- ▶ FOGPROOF
- ▶ SHOCKPROOF

SKU	MAGNIFICATION X OBJECTIVE LENS DIAMETER	LINEAR FIELD OF VIEW (@ 1000 YARDS)	ANGULAR FIELD OF VIEW	CLOSE FOCUS	EYE RELIEF	LENGTH	WEIGHT
RT155	15x50	215'	4.1°	12.0'	16.0mm	8.0"	15.2 oz.

For a description of each feature, see page 132.



VORTEXOPTICS.COM

# RECCE PRO<sup>®</sup> HD

MONOCULAR



## THE PERFECT SIDEKICK.

Carry precision and speed at your fingertips with the RECCE Pro<sup>®</sup> HD monocular. HD glass, an MRAD milling reticle, and a compact form factor make it the perfect solution for shooters who need to spot and call shots from the bench, or in the line of duty. An integrated carry clip provides quick external access on webbing or flat-edged surfaces. Weighing in at 10.5 ounces, it's ready to handle any environment with fully waterproof and fogproof construction.

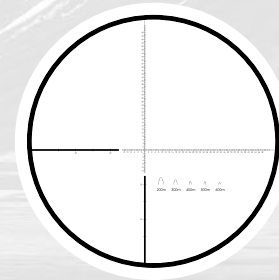

### R/T RANGING RETICLE

Uses MRAD-based subtensions and includes silhouettes for quick ranging. The angular measurements allow you to calculate ranges when comparing the reticle to objects of known dimension.

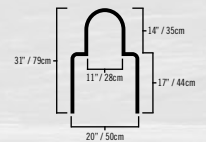

### FEATURES

- ▶ HD OPTICAL SYSTEM
- ▶ XR™ LENS COATINGS
- ▶ ARMORTEK<sup>®</sup>
- ▶ RUBBER ARMOR
- ▶ ARGON GAS PURGED
- ▶ WATERPROOF
- ▶ FOGPROOF
- ▶ SHOCKPROOF

For a description of each feature, see page 132.

SKU	MAGNIFICATION X OBJECTIVE LENS DIAMETER	LINEAR FIELD OF VIEW (@ 1000 YARDS)	ANGULAR FIELD OF VIEW	CLOSE FOCUS	EYE RELIEF	LENGTH	WEIGHT
RP-100	8x32	400'	7.6°	5.0'	14.5mm	6.0"	10.5 oz.





# SOLO<sup>®</sup> R/T

MONOCULAR

WINGED EYECUP



UTILITY CLIP  
(NOT SHOWN)

## FIND YOUR TARGET. FIND YOUR CALLING.

The incredibly light form factor of our Solo<sup>®</sup> monocular with a tactical twist, the Solo<sup>®</sup> R/T monocular features an MRAD-based ranging reticle for accurate range estimation and shot calls. The powerful optical system delivers bright images in a compact, lightweight, and easy-to-handle unit that's both waterproof and fogproof. With an integrated utility clip, it attaches to webbing or other flat-edged surfaces for quick access.

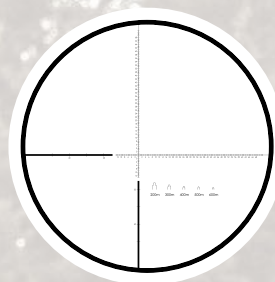

### R/T RANGING RETICLE

Uses MRAD-based subtensions and includes silhouettes for quick ranging. The angular measurements allow you to calculate ranges when comparing the reticle to objects of known dimension.

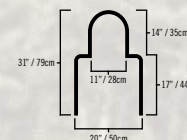

### FEATURES

- ▶ SD OPTICAL SYSTEM
- ▶ FULLY MULTI-COATED LENSES
- ▶ RUBBER ARMOR
- ▶ NITROGEN GAS PURGED
- ▶ WATERPROOF
- ▶ FOGPROOF
- ▶ SHOCKPROOF

SKU	MAGNIFICATION X OBJECTIVE LENS DIAMETER	LINEAR FIELD OF VIEW (@ 1000 YARDS)	ANGULAR FIELD OF VIEW	CLOSE FOCUS	EYE RELIEF	LENGTH	WEIGHT
SOL-3608-RT	8x36	393'	7.5°	16.4'	18.0mm	5.4"	10.7 oz.

For a description of each feature, see page 132.



# SOLO<sup>®</sup>

MONOCULAR



## GO SOLO.

The Solo<sup>®</sup> monocular delivers quality viewing for outdoor enthusiasts looking to bring nature closer with an optic that won't weigh them down. With models weighing between 5.6 ounces and 9.7 ounces, this monocular is ultra-compact, and features an integral utility clip to keep it close at hand. From bow hunters to backpackers, the Solo<sup>®</sup> makes a great addition to any gear list.

SKU	MAGNIFICATION X OBJECTIVE LENS DIAMETER	LINEAR FIELD OF VIEW (@ 1000 YARDS)	ANGULAR FIELD OF VIEW	CLOSE FOCUS	EYE RELIEF	LENGTH	WEIGHT
S136	10x36	325'	6.2°	16.4'	15.0mm	4.9"	9.3 oz.
S836	8x36	393'	7.5°	16.4'	18.0mm	4.9"	9.7 oz.
S105	10x25	315'	6.0°	16.4'	14.5mm	4.4"	5.6 oz.
S825	8x25	378'	7.2°	16.4'	15.0mm	4.4"	5.6 oz.

### FEATURES

- ▶ SD OPTICAL SYSTEM
- ▶ FULLY MULTI-COATED LENSES
- ▶ RUBBER ARMOR
- ▶ NITROGEN GAS PURGED
- ▶ WATERPROOF
- ▶ FOGPROOF
- ▶ SHOCKPROOF

For a description of each feature, see page 132.





EPISODE 176

EPISODE 135



EPISODE 116



EPISODE 168



EPISODE 170





# VORTEX NATION™ PODCAST

Brought to you by hunting, shooting, public lands, the second amendment, and good food, the Vortex Nation™ Podcast is your direct link to the brightest minds and hottest topics in the hunting, shooting, optics, outdoor, and firearms space.

Whether you're listening while fighting commuter traffic or tuning in while turning a wrench in your garage, we've got more than 300 episodes to keep you in the know and on-target. Episodes ranging from quick 10-minute talks on cartridges, to deep dives with real-life snipers, interviews with pro staff and celebrity guests, and informational pieces on choosing the right optic for your rig — there's something for everyone and every interest.

Get your listen on now by scanning the code below. And if you're already a fan, be sure to check back weekly for new uploads! You won't regret it!



- EPISODE **116** **Choosing the Right Riflescope**
- EPISODE **135** **The Life of a Sniper**
- EPISODE **168** **Budget Rifles – What You're Getting and What You're Missing**
- EPISODE **170** **Steve Rinella's Near Death Experiences**
- EPISODE **176** **Building an AR – Where to Spend Your Money and Where to Save**





# spotting scopes



# SPOTTING SCOPES COMPARISON CHART



	RAZOR® HD	VIPER® HD	DIAMONDBACK® HD
<b>Configurations</b>	27-60x85 22-48x65 11-33x50	20-60x85 15-45x65	20-60x85 16-48x65
<b>Eyepiece Position Options</b>	Angled Straight	Angled Straight	Angled Straight

## ANGLED VS. STRAIGHT



	ANGLED	STRAIGHT
<b>Pros</b>	<ul style="list-style-type: none"> <li>• Can be easily used from the side, out of the way of your rifle or other equipment.</li> <li>• More easily shared between multiple users on a tripod.</li> <li>• More comfortable to use from a seated position.</li> <li>• More comfortable when glassing at a steep upward angle.</li> </ul>	<ul style="list-style-type: none"> <li>• Slides into and out of a pack more easily, and takes up less space.</li> <li>• Very intuitive to locate targets (wherever your head/eyes are facing, so is the scope).</li> <li>• Easy to get behind when looking down at steep angles from a height.</li> <li>• Generally easier to use from a vehicle.</li> </ul>
<b>Cons</b>	<ul style="list-style-type: none"> <li>• Takes up more space in a pack/case.</li> <li>• Not always intuitive to locate your target/quarry (what you're seeing isn't necessarily where your eyes are pointed).</li> <li>• Difficult to use when glassing at a steep downward angle from a height.</li> </ul>	<ul style="list-style-type: none"> <li>• User must always be directly behind optic.</li> <li>• Difficult to share on a tripod between users of different heights.</li> <li>• Difficult to use while seated and scanning a landscape.</li> <li>• Often needs to be set higher on a tripod, which can be more tippy/unsteady.</li> </ul>



RAZOR® HD



FIND YOUR  
peak.

VORTEXOPTICS.COM

# RAZOR<sup>®</sup> HD

SPOTTING SCOPE



## FIND YOUR PEAK.

One look through the eyepiece and you know: This is how a spotting scope should be. Setting the standard in high-end optical technologies, precision craftsmanship, and ultra-sleek functionality, the Razor<sup>®</sup> HD is one of the finest scopes on the market. Advanced optical elements eliminate aberrations for distortion-free, flat-field images with unmatched, edge-to-edge sharpness, as well as remarkable clarity, resolution, and color accuracy. Hunters, shooters, and outdoor enthusiasts who need a premium spotter that performs at the highest level have found their match.

Note – Custom-fitted neoprene case included with 85mm and 65mm models. Padded case included with the 50mm models.



SKU	MAGNIFICATION X OBJECTIVE LENS DIAMETER	EYEPIECE POSITION	LINEAR FIELD OF VIEW (@ 1000 YARDS)	ANGULAR FIELD OF VIEW	CLOSE FOCUS	EYE RELIEF	LENGTH	WEIGHT
RS-85A	27-60x85	Angled	117' - 68'	2.2° - 1.3°	16.4'	16.7mm - 17.0mm	15.5"	65.6 oz.
RS-85S		Straight					16.2"	
RS-65A	22-48x65	Angled	138' - 84'	2.7° - 1.6°	26.2'	16.7mm - 17.0mm	14.8"	56.8 oz.
RS-65S		Straight					15.6"	
RZR-50A1	11-33x50	Angled	191' - 96'	3.6° - 1.8°	6.6'	16.0mm - 19.0mm	10.3"	25.0 oz.
RZR-50S1		Straight					11.0"	

- ### FEATURES
- ▶ HD OPTICAL SYSTEM
  - ▶ XR™ PLUS LENS COATINGS
  - ▶ APOCHROMATIC
  - ▶ ARMORTEK®
  - ▶ DIELECTRIC PRISM COATINGS
  - ▶ PLASMA TECH
  - ▶ RUBBER ARMOR
  - ▶ ARGON GAS PURGED
  - ▶ WATERPROOF
  - ▶ FOGPROOF
  - ▶ SHOCKPROOF
  - ▶ TRIPOD ADAPTABLE

For a description of each feature, see page 132.





VIPER® HD



CROSS EVERYTHING  
off your list.

VORTEXOPTICS.COM

# VIPER<sup>®</sup> HD

SPOTTING SCOPE



## CROSS EVERYTHING OFF YOUR LIST.

We love a bit of reverse sticker shock, and the Viper<sup>®</sup> HD is a high-end spotter without the high-end price tag. It proves you no longer need to drop four figures to get premium performance and features, with an HD optical system bringing even the finest, most distant details in for a closer look. Built to withstand the harshest rain, snow, heat, or abuse you can dish out, the Viper<sup>®</sup> HD is a perfect fit whether you're in the hills or at the range.

Note – Custom-fitted neoprene case included.



SKU	MAGNIFICATION X OBJECTIVE LENS DIAMETER	EYEPiece POSITION	LINEAR FIELD OF VIEW (@ 1000 YARDS)	ANGULAR FIELD OF VIEW	CLOSE FOCUS	EYE RELIEF	LENGTH	WEIGHT
V502	20-60x85	Angled	101' - 50'	1.9° - 1.0°	36.0'	17.8mm - 19.6mm	17.5"	76.6 oz.
V503		Straight					18.0"	76.4 oz.
V500	15-45x65	Angled	137' - 68'	2.6° - 1.3°	23.0'	17.8mm - 19.6mm	14.0"	59.0 oz.
V501		Straight					14.6"	58.8 oz.

- ### FEATURES
- ▶ HD OPTICAL SYSTEM
  - ▶ XR™ PLUS LENS COATINGS
  - ▶ DIELECTRIC PRISM COATINGS
  - ▶ ARMORTEK<sup>®</sup>
  - ▶ RUBBER ARMOR
  - ▶ ARGON GAS PURGED
  - ▶ WATERPROOF
  - ▶ FOGPROOF
  - ▶ SHOCKPROOF
  - ▶ TRIPOD ADAPTABLE

For a description of each feature, see page 132.





DIAMONDBACK® HD

EVOLUTION NEVER LOOKED  
so good.

VORTEXOPTICS.COM



# DIAMONDBACK® HD

SPOTTING SCOPE



## EVOLUTION NEVER LOOKED SO GOOD.

Glassing out west demands an HD optic, but other systems can't get you the clarity you need to see a tail twitch in low light, or pick a tine out of dense cover. The redesigned Diamondback® HD spotting scopes have all the horsepower the long-distance hunter needs, and they excel in low light — right when you need it most. We've also streamlined the exterior for a sleeker, snag-free profile, building in a helical focus wheel. For the biggest hunt of your year, or your third time out this season, the all-new Diamondback® HD spotters deliver the power to focus on the thrill of your hunt.

Note – Custom-fitted neoprene case included.



SKU	MAGNIFICATION X OBJECTIVE LENS DIAMETER	EYEPIECE POSITION	LINEAR FIELD OF VIEW (@ 1000 YARDS)	ANGULAR FIELD OF VIEW	CLOSE FOCUS	EYE RELIEF	LENGTH	WEIGHT
DS-85A	20-60x85	Angled	108' - 60'	2.1° - 1.1°	24.6'	18.3mm - 20.3mm	16.0"	60.9 oz.
DS-85S		Straight					15.8"	61.3 oz.
DS-65A	16-48x65	Angled	138' - 72'	2.6° - 1.4°	16.4'	18.3mm - 20.3mm	14.3"	49.8 oz.
DS-65S		Straight					13.7"	50.4 oz.

- ### FEATURES
- ▶ HD OPTICAL SYSTEM
  - ▶ FULLY MULTI-COATED LENSES
  - ▶ ARMORTEK®
  - ▶ RUBBER ARMOR
  - ▶ ARGON GAS PURGED
  - ▶ WATERPROOF
  - ▶ FOGPROOF
  - ▶ SHOCKPROOF
  - ▶ TRIPOD ADAPTABLE

For a description of each feature, see page 132.





PUBLIC LANDS

# THIS IS #YOURLAND

VORTEXOPTICS.COM

# CELEBRATE PUBLIC LANDS

Whether you're a hunter, shooter, or both, the vast amount of public lands available for you to enjoy throughout the United States should never be taken for granted.

Understanding exactly how these public lands are funded and maintained can be tricky at times, but here at Vortex Optics, we're working to change that — we've assembled some of our favorite podcasts, videos, and blogs to help shine more light on how it all works.

**SCAN THE QR CODES BELOW  
TO ACCESS MORE INFORMATION ON PUBLIC LANDS**



#### THE TRCP & PUBLIC LANDS

A deep dive into public lands with Joel Webster from the Theodore Roosevelt Conservation Partnership. Learn how TRCP interacts with public land issues and why you should care.



#### PUBLIC LAND FUNDING EXPLAINED

Hunters and shooters play an integral role in conservation. Whether you're purchasing a hunting license or shooting recreationally, you've got skin in the game. Join Jason Matzinger for an in-depth look at how public lands are funded.



#### HOW TO SHOOT SAFELY ON PUBLIC LANDS

It may be surprising to some, but even in this day and age there are still places Americans can go to shoot for free. Find your own secret honey hole to shoot safely on public land.

## 5 facts about #ourland

- The public land model is unique to the United States.
- The United States has 640 million acres of federally owned public land.
- 28% of the United States is public land.
- The United States uses 4 major federal land management agencies, including the Bureau of Land Management, U.S. Fish and Wildlife Service, National Park Service, and U.S. Forest Service.
- The top 3 states for public land by percentage are Nevada (79.6%), Utah (63.1%), and Idaho (61.6%).





# tripods



# TRIPODS

## COMPARISON CHART



	RADIAN™ CARBON BALL HEAD	RADIAN™ CARBON LEVELING HEAD	RIDGEVIEW™ CARBON	SUMMIT™ CARBON II	HIGH COUNTRY™ II
<b>Intended Use</b>	Precision Shooting	Precision Shooting	Stand-Up Glassing	Packable, Seated Glassing	General Purpose Glassing
<b>Head Style</b>	Ball Head	Leveling Head	2-Way Pan Head	2-Way Pan Head	2-Way Pan Head
<b>Weight</b>	7.3 lbs.	6.1 lbs.	3.2 lbs.	2.5 lbs.	4.0 lbs.
<b>Max. Load</b>	55 lbs.	44 lbs.	22 lbs.	22 lbs.	22 lbs.
<b>Min. Height</b>	8.3"	7.8"	8.3"	6.3"	11.3"
<b>Max. Height</b>	67.3"	64.3"	73.8"	53.3"	62.5"
<b>Leg Material</b>	Carbon Fiber	Carbon Fiber	Carbon Fiber	Carbon Fiber	Aluminum
<b>Leg Locks</b>	Twist	Twist	1/4 Turn	1/4 Turn	Flip Lever



# RADIAN™ CARBON

CARBON FIBER TRIPOD + BALL HEAD OR LEVELING HEAD

**LEVELING HEAD - 44 LBS. MAX LOAD**  
**BALL HEAD - 55 LBS. MAX LOAD**

Perfect for large binoculars, spotting scopes, and rifles.

### CARBON FIBER LEG CONSTRUCTION

Perfect combination of strength and lightweight build.



## THE ULTIMATE IN STABILITY, PRECISION, AND PERSPECTIVE.

There's no way something this precise should be this tough, but the Radian™ Carbon changes the rules when it comes to getting the utmost finesse out of a rock-solid platform. Fully carbon fiber legs and aluminum construction make for an extremely high strength-to-weight ratio, supporting heavy loads while keeping the Radian™ Carbon easy to pack. Along with great strength, you get great precision with an integrated level. Choose between a ball head or a leveling head so you can swap out all your long-range tools quickly with the features you need, including Arca-Swiss compatibility and quick release. Whether you're calling shots, or looking for a solid base for your rifle, the Radian™ Carbon makes sure you're ready.



### BALL HEAD

Independent pan movement and tension control with integrated level. 45 degrees of tilt and notches for up to 90 degrees for all the travel you need.



### LEVELING HEAD

Smooth, intuitive controls with rubberized, twist-to-lock/unlock handle. +/-15 degrees of leveling capability guarantee precise positioning.

## FEATURES

- ▶ 3-ANGLE LEG PIVOT LOCKS
- ▶ RUBBER FEET
- ▶ SPIKED FEET
- ▶ DETACHABLE COUNTER-WEIGHT HOOK

SKU	HEAD STYLE	WEIGHT	MAX LOAD	HEIGHT (MIN-MAX)	FOLDED DIMENSIONS (HEIGHT X WIDTH)	LEG MATERIAL	LEG SECTIONS	LEG ANGLES	LEG LOCKS	HEAD MOUNT
TR-RADB	Ball	7.3 lbs.	55 lbs.	8.3" - 67.3"	28.0" x 6.0"	Carbon Fiber	4	3	Twist	Arca-Swiss
TR-RADL	Leveling	6.1 lbs.	44 lbs.	7.8" - 64.3"	25.5" x 6.0"	Carbon Fiber	4	3	Twist	Arca-Swiss

For a description of each feature, see page 132.



# RIDGEVIEW™ CARBON

CARBON FIBER TRIPOD + PAN HEAD



**22 LBS. MAX LOAD**  
Perfect for large binoculars and spotting scopes.

**EXTENDED HEIGHT**  
Maximum height of 73.8" for glassing while standing.

**2-WAY PAN HEAD**  
Provides simple, intuitive controls and full range of motion.

**CARBON FIBER LEG CONSTRUCTION**  
Perfect combination of strength and lightweight build.

## THE HEIGHT OF STABILITY.

Ridgeview™ Carbon raises your long-range tools to new heights without sacrificing stability or strength. Our tallest tripod, the Ridgeview™ Carbon is perfect for stand-up glassing, and it's built on a carbon frame for higher performance at higher heights. Adjustments are smooth and precise, thanks to a 2-Way Pan Head, you can quickly switch out your long-range tools with the Arca-Swiss compatible quick-release system. When you need stability and strength you can stand behind, put Ridgeview™ Carbon in your pack.



### compatible with PRO LEVELING HEAD

Integrated level for precise positioning, plus twist to unlock/lock knurled control ring to keep you locked in.

\*SOLD SEPARATELY

SKU	HEAD STYLE	WEIGHT	MAX LOAD	HEIGHT (MIN-MAX)	FOLDED DIMENSIONS (HEIGHT X WIDTH)	LEG MATERIAL	LEG SECTIONS	LEG ANGLES	LEG LOCKS	HEAD MOUNT
TR-RVC	2-Way Pan	3.2 lbs.	22 lbs.	8.3" - 73.8"	29.0" x 3.2"	Carbon Fiber	3	3	1/4 Turn	Arca-Swiss

### FEATURES

- ▶ 3-ANGLE LEG PIVOT LOCKS
- ▶ RUBBER FEET
- ▶ DETACHABLE COUNTER-WEIGHT HOOK

For a description of each feature, see page 132.





# SUMMIT™ CARBON II

CARBON FIBER TRIPOD + PAN HEAD

### 22 LBS. MAX LOAD

Perfect for large binoculars and spotting scopes.

### 2-WAY PAN HEAD

Provides simple, intuitive controls and full range of motion.

### COMPACT, LIGHTWEIGHT DESIGN

2.5 lbs. and compact folding design for ultimate packability.

### CARBON FIBER LEG CONSTRUCTION

Perfect combination of strength and lightweight build.



## GO LIGHTER, GO FASTER, GO ANYWHERE.

When every ounce in your pack out counts, count on the Summit™ Carbon II to keep you moving without sacrificing stability. Carbon fiber construction keeps it light and strong, while the four leg sections provide the ultimate in packability, letting the Summit™ Carbon II collapse to a smaller size, yet still go tall enough to get you the height you need. To cut down on weight even more, Summit™ Carbon II comes with a detachable center column to go taller when you need it and stow away for lower viewing and packability when you don't. Make light work of your next adventure with Summit™ Carbon II.



### compatible with PRO LEVELING HEAD

Integrated level for precise positioning, plus twist to unlock/lock knurled control ring to keep you locked in.

\*SOLD SEPARATELY

SUMMIT™ CARBON II / HIGH COUNTRY™ II

VORTEXOPTICS.COM

SKU	HEAD STYLE	WEIGHT	MAX LOAD	HEIGHT (MIN-MAX)	FOLDED DIMENSIONS (HEIGHT X WIDTH)	LEG MATERIAL	LEG SECTIONS	LEG ANGLES	LEG LOCKS	HEAD MOUNT
TR-SMC	2-Way Pan	2.5 lbs.	22 lbs.	6.3" - 53.3"	18.1" x 3.0"	Carbon Fiber	4	3	1/4 Turn	Arca-Swiss

### FEATURES

- ▶ 3-ANGLE LEG PIVOT LOCKS
- ▶ DETACHABLE COUNTER-WEIGHT HOOK
- ▶ RUBBER FEET

For a description of each feature, see page 132.





# HIGH COUNTRY™ II

ALUMINUM TRIPOD + PAN HEAD



**22 LBS. MAX LOAD**  
Perfect for large binoculars and spotting scopes.

**2-WAY PAN HEAD**  
Provides simple, intuitive controls and full range of motion.

**ALUMINUM LEG CONSTRUCTION**  
Excellent balance of packability and durability.

## OWN THE HIGH GROUND.

Need a tripod with the ideal combination of stability and packability? The High Country™ II delivers, with a machined aluminum design offering outstanding durability in a lightweight package. In-the-field adjustments are smooth and precise, thanks to a 2-Way Pan and Tilt Head, and you can switch out your long-range tools with ease, thanks to the Arca-Swiss compatible quick-release system. Whether you're working grasslands, forests, or mountains, the High Country™ II is rock-solid on any surface, with rubber feet for a non-slip grip. For reliable, packable performance, grab a High Country™ II and take the high ground with you.



### compatible with PRO LEVELING HEAD

Integrated level for precise positioning, plus twist to unlock/lock knurled control ring to keep you locked in.

\*SOLD SEPARATELY

SKU	HEAD STYLE	WEIGHT	MAX LOAD	HEIGHT (MIN-MAX)	FOLDED DIMENSIONS (HEIGHT X WIDTH)	LEG MATERIAL	LEG SECTIONS	LEG ANGLES	LEG LOCKS	HEAD MOUNT
TR-HCY	2-Way Pan	4.0 lbs.	22 lbs.	11.3" - 62.5"	24.3" x 4.0"	Aluminum	3	3	Flip Lever	Arca-Swiss

### FEATURES

- ▶ 3-ANGLE LEG PIVOT LOCKS
- ▶ DETACHABLE COUNTER-WEIGHT HOOK
- ▶ RUBBER FEET

For a description of each feature, see page 132.





# FEATURES



## UHD OPTICAL SYSTEM

Ultra-high definition optical quality and prescription for unparalleled image resolution that cuts chromatic aberration; providing exceptional color fidelity, edge-to-edge sharpness, and light transmission.



## HD OPTICAL SYSTEM

Optimized with select glass elements to deliver exceptional resolution, cut chromatic aberration and provide outstanding color fidelity, edge-to-edge sharpness, and light transmission.



## XD™ OPTICAL SYSTEM

Premium optical system delivers impressive resolution, edge-to-edge sharpness, greatly reduces chromatic aberration and guarantees bright, high-contrast images.



## SD OPTICAL SYSTEM

High-quality optical system reduces chromatic aberration and delivers clean, bright, sharp images.



## XR™ PLUS LENS COATINGS

Ultimate anti-reflective coatings on all air-to-glass surfaces provide maximum light transmission for peak clarity and the pinnacle of low-light performance.



## XR™ LENS COATINGS

Premium anti-reflective coatings on all air-to-glass surfaces provide superior light transmission for exceptional clarity and low-light performance.



## FULLY MULTI-COATED LENSES

Anti-reflective coatings on all air-to-glass surfaces provide increased light transmission for greater clarity and low-light performance.



## DIELECTRIC PRISM COATINGS

Multi-layer prism coatings provide bright, clear, color-accurate images.



## ALO ALIGNMENT

Proprietary, precision-laser process, perfectly aligns lens elements to ensure the absolute best image.



## PHASE CORRECTION

Coating on roof prism enhances resolution and contrast.



## APO (APOCHROMATIC)

Index-matched lenses correct color across the entire visual spectrum.



## ARMORTEK®

Ultra-hard exterior lens coatings defend against scratches, oil, and dirt.



## RUBBER ARMOR

Provides a secure, non-slip grip, and durable external protection.



## PLASMA TECH

Cutting edge application process provides unparalleled coating durability and performance.



## ARGON GAS PURGED

Gas purged and O-ring sealed for superior fogproof and waterproof performance in the most extreme conditions.



## NITROGEN GAS PURGED

Gas purged and O-ring sealed for fogproof and waterproof performance in all conditions.



## SHOCKPROOF

Designed to withstand the highest levels of recoil and impact.



## WATERPROOF

Designed to withstand harsh weather conditions.



## FOGPROOF

Designed to withstand a wide range of temperatures.



## TRIPOD ADAPTABLE

Allowing use on a tripod or car window mount. Tripod adapter may be required.

# RIFLESCOPE DIMENSIONS

These dimensions will help determine which rings and flip caps will work best for each scope. For more details, please visit the riflescope specification pages on our website.

**Note:** Dimensions measured in inches.

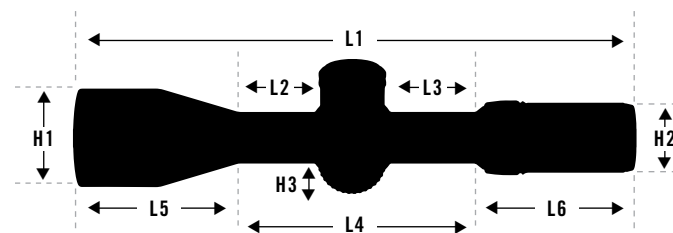

MODEL	LENGTH						HEIGHT		
	L1	L2	L3	L4	L5	L6	H1	H2	H3
<b>Razor® HD Gen III</b>									
6-36x56	15.25	1.95	2.25	6.20	5.50	3.55	2.56	1.80	0.17
1-10x24	10.10	2.00	2.50	6.34	0.40	3.40	1.33	1.81	0.20
<b>Razor® HD Gen II</b>									
4.5-27x56	14.40	1.96	2.17	6.11	4.13	4.10	2.55	1.81	0.18
<b>Razor® HD Gen II-E</b>									
1-6x24	10.10	2.50	1.50	5.67	0.85	3.60	1.29	1.81	0.12
<b>Razor® HD LHT</b>									
4.5-22x50	13.25	1.90	2.20	5.61	4.20	3.40	2.33	1.70	0.12
3-15x50	13.59	2.16	2.10	5.73	4.30	3.41	2.32	1.70	0.10
3-15x42	13.39	2.67	2.08	6.24	3.75	3.40	2.01	1.70	0.12
<b>Golden Eagle® HD</b>									
15-60x52	16.10	3.50	2.28	7.50	5.51	3.09	2.41	1.73	0.15
<b>Viper® PST Gen II</b>									
5-25x50	15.79	2.37	2.58	6.59	5.60	3.59	2.30	1.81	0.12
3-15x44	14.30	2.32	2.59	6.56	4.15	3.59	2.08	1.81	0.13
2-10x32	12.64	2.36	2.53	6.54	2.52	3.59	1.61	1.81	0.12
1-6x24	10.83	3.00	2.19	6.85	0.50	3.44	1.29	1.81	0.13
<b>Viper® HST</b>									
6-24x50	15.41	2.60	2.20	6.24	6.70	3.60	2.26	1.65	0.09
4-16x44	13.33	2.10	2.17	5.61	4.11	3.60	2.03	1.65	0.09
<b>Viper® HSLR™</b>									
6-24x50	15.41	2.60	2.20	6.24	6.70	3.60	2.26	1.65	0.09
4-16x50	13.56	2.10	2.21	5.65	4.22	3.60	2.26	1.65	0.08
<b>Viper® HS™</b>									
4-16x50	13.60	2.10	2.23	5.67	4.33	3.60	2.27	1.65	0.07
4-16x44	13.41	2.13	2.19	5.63	4.20	3.60	2.03	1.65	0.07
2.5-10x44	12.00	2.07	2.21	5.60	2.90	3.60	2.03	1.65	0.07
<b>Viper®</b>									
6.5-20x50	14.44	2.80	2.20	6.37	4.80	3.24	2.27	1.72	0.12

MODEL	LENGTH						HEIGHT		
	L1	L2	L3	L4	L5	L6	H1	H2	H3
<b>Strike Eagle®</b>									
5-25x56	14.60	2.04	2.73	6.46	4.78	3.43	2.51	1.80	0.12
1-8x24	10.00	2.88	1.88	6.40	—	3.46	1.18	1.69	0.15
1-6x24	10.50	2.84	2.13	6.53	—	3.87	1.18	1.69	0.17
<b>Venom®</b>									
5-25x56	15.25	2.59	2.44	6.90	4.80	3.44	2.54	1.81	0.13
<b>Diamondback® Tactical</b>									
6-24x50	14.28	2.30	2.70	6.56	3.98	3.77	2.25	1.73	0.15
4-16x44	14.06	2.24	2.70	6.43	3.83	3.77	2.01	1.73	0.15
4-12x40	14.08	1.90	2.15	5.30	5.30	3.43	1.86	1.71	0.12
<b>Diamondback®</b>									
4-12x40	12.00	2.46	2.15	5.85	3.00	3.10	1.89	1.69	0.11
3.5-10x50	12.50	2.15	2.10	5.48	3.85	3.10	1.89	1.69	0.10
3-9x40	11.61	2.10	2.10	5.40	3.07	3.10	1.89	1.69	0.09
2-7x35 Rimfire	11.60	1.83	2.10	5.16	3.35	3.10	1.72	1.69	0.09
1.75-5x32	10.20	1.90	1.96	5.10	1.90	3.10	1.55	1.69	0.10
<b>Crossfire® II</b>									
6-24x50	14.50	1.97	2.60	5.90	5.00	3.60	2.52	1.73	0.09
6-18x44	13.46	1.97	2.20	5.40	4.55	3.52	2.30	1.61	0.10
4-16x50	14.37	1.90	2.30	5.60	5.16	3.60	2.52	1.73	0.09
4-12x50	14.30	2.20	2.20	5.66	5.07	3.56	2.54	1.73	0.10
4-12x44	13.43	2.30	1.90	5.50	4.27	3.60	2.01	1.71	0.09
4-12x40	13.60	2.25	1.88	5.50	4.67	3.60	2.16	1.68	0.09
3-12x56 Hog Hunter	13.46	1.57	2.05	5.00	5.00	3.54	2.80	1.73	0.10
3-9x50	12.80	2.00	1.80	5.10	4.10	3.65	2.27	1.73	0.09
3-9x40	12.20	2.10	1.82	5.10	3.50	3.60	1.89	1.68	0.10
2-7x32 Crossbow Kit	9.50	1.69	1.50	4.45	1.95	3.06	1.56	1.52	0.07
2-7x32 Scout	10.71	1.86	1.54	4.63	3.10	2.90	1.53	1.61	0.12
2-7x32 Rimfire	11.45	2.21	1.63	5.10	2.75	3.60	1.53	1.73	0.09
2-7x32	11.45	2.21	1.63	5.10	2.75	3.60	1.53	1.73	0.09
1-4x24	9.61	2.78	1.90	6.17	—	3.44	1.18	1.73	0.09

\*Zero stop will limit travel.

# RIFLESCOPE SPECS

SKU	MAGNIFICATION X OBJECTIVE LENS DIAMETER	FOCAL PLANE	RETICLE	ILLUMINATION	EYE RELIEF	LINEAR FIELD OF VIEW (@ 100 YARDS)	ZERO STOP	TURRET STYLE	TUBE SIZE	ADJUSTMENT GRADUATION	TRAVEL PER ROTATION	MAX ELEVATION ADJUSTMENT	MAX WINDAGE ADJUSTMENT	PARALLAX SETTING	LENGTH	WEIGHT
<b>Razor® HD Gen III</b>																
RZR-63602	6-36x56	FFP	EBR-7D MRAD	Yes	3.5"	21.3' - 3.5'	L-Tec+™	Exposed	34mm	.1 MRAD	10 MRAD	36.1 MRAD*	15.5 MRAD*	10 yds. - ∞	15.3"	45.1 oz.
RZR-63601			EBR-7D MOA							1/4 MOA	25 MOA	121 MOA*	52.5 MOA*			
RZR-11002	1-10x24	FFP	EBR-9 MRAD	Yes	3.6"	116.0' - 11.7'	N/A	Capped	34mm	.1 MRAD	10 MRAD	30 MRAD	30 MRAD	150 yds.	10.1"	21.5 oz.
RZR-11001			EBR-9 BDC MOA							1/4 MOA	25 MOA	120 MOA	120 MOA			
<b>Razor® HD Gen II</b>																
RZR-42709	4.5-27x56	FFP	Horus™ H59™ MRAD	Yes	3.7"	25.3' - 4.4'	L-Tec™	Exposed	34mm	.1 MRAD	10 MRAD	33 MRAD*	14 MRAD*	32 yds. - ∞	14.4"	48.5 oz.
RZR-42710			Horus™ Tremor3™ MRAD													
RZR-42708			EBR-7C MRAD													
RZR-42707			EBR-7C MOA							1/4 MOA	25 MOA	113.5 MOA*	48 MOA*			
<b>Razor® HD Gen II-E</b>																
RZR-16009	1-6x24	SFP	VMR-2 MRAD	Yes	4.0"	115.2' - 20.5'	N/A	Capped	30mm	.2 MRAD	20 MRAD	43 MRAD	43 MRAD	100 yds.	10.1"	21.5 oz.
RZR-16010			VMR-2 MOA							1/2 MOA	50 MOA	150 MOA	150 MOA			
RZR-16008			JM-1 BDC MOA													
<b>Razor® HD LHT™</b>																
RZR-42202	4.5-22x50	FFP	XLR-2 MRAD	Yes	4.0"	23.5' - 4.7'	RevStop®	Elevation: Exposed Windage: Capped	30mm	.1 MRAD	6 MRAD	22.4 MRAD*	12.7 MRAD	25m - ∞	13.3"	21.7 oz.
RZR-42201			XLR-2 MOA							1/4 MOA	15 MOA	75 MOA*	45 MOA	25 yds. - ∞		
RZR-31503	3-15x50	SFP	G4i BDC MRAD	Yes	3.8"	35.3' - 7.0'	RevStop®	Elevation: Exposed Windage: Capped	30mm	.1 MRAD	6 MRAD	23 MRAD*	23 MRAD	20m - ∞	13.6"	20.5 oz.
RZR-31502	3-15x42	SFP	HSR-5i MRAD	Yes	3.8"	35.3' - 7.0'	RevStop®	Elevation: Exposed Windage: Capped	30mm	.1 MRAD	6 MRAD	23 MRAD*	23 MRAD	20m - ∞	13.4"	19.1 oz.
RZR-31501			HSR-5i MOA							1/4 MOA	15 MOA	80 MOA*	80 MOA	20 yds. - ∞		
<b>Golden Eagle® HD</b>																
TCS-1503	15-60x52	SFP	ECR-1 MOA	No	3.9"	6.3' - 1.7'	N/A	Exposed	30mm	1/8 MOA	10 MOA	55 MOA	45 MOA	20 yds. - ∞	16.1"	29.7 oz.
TCS-1501			SCR-1 MOA													
<b>Viper® PST™ Gen II</b>																
PST-5259	5-25x50	FFP	EBR-7C MRAD	Yes	3.4"	24.1' - 4.8'	RZR™	Exposed	30mm	.1 MRAD	10 MRAD	20 MRAD	10 MRAD	25 yds. - ∞	15.8"	31.2 oz.
PST-5256			EBR-7C MOA							1/4 MOA	25 MOA	70 MOA	35 MOA			
PST-5251	3-15x44	SFP	EBR-4 MOA	Yes	3.4"	41.2' - 8.6'	RZR™	Exposed	30mm	.1 MRAD	10 MRAD	22 MRAD	11 MRAD	20 yds. - ∞	14.3"	28.1 oz.
PST-3159			EBR-7C MRAD													
PST-3156			EBR-7C MOA							1/4 MOA	25 MOA	75 MOA	40 MOA			
PST-3151	2-10x32	FFP	EBR-4 MOA	Yes	3.2"	58.3' - 11.7'	RZR™	Exposed	30mm	.1 MRAD	10 MRAD	26 MRAD	26 MRAD	20 yds. - ∞	12.6"	26.3 oz.
PST-2105			EBR-4 MRAD							1/4 MOA	25 MOA	90 MOA	90 MOA			
PST-2101	1-6x24	SFP	EBR-4 MOA	Yes	3.8"	112.5' - 18.8'	N/A	Capped	30mm	.2 MRAD	16 MRAD	46 MRAD	46 MRAD	100 yds.	10.8"	22.7 oz.
PST-1607			VMR-2 MRAD							1/2 MOA	40 MOA	160 MOA	160 MOA			
PST-1605			VMR-2 MOA													

\*Zero stop will limit travel.

SKU	MAGNIFICATION X OBJECTIVE LENS DIAMETER	FOCAL PLANE	RETICLE	ILLUMINATION	EYE RELIEF	LINEAR FIELD OF VIEW (@ 100 YARDS)	ZERO STOP	TURRET STYLE	TUBE SIZE	ADJUSTMENT GRADUATION	TRAVEL PER ROTATION	MAX ELEVATION ADJUSTMENT	MAX WINDAGE ADJUSTMENT	PARALLAX SETTING	LENGTH	WEIGHT
<b>Viper<sup>™</sup> HST<sup>™</sup></b>																
VHS-4310	6-24x50	SFP	VMR-1 MRAD	No	4.0"	17.8' - 5.1'	CRS <sup>™</sup>	Exposed	30mm	.1 MRAD	5 MRAD	19 MRAD	19 MRAD	50 yds. - ∞	15.4"	22.6 oz.
VHS-4325			VMR-1 MOA							1/4 MOA	12 MOA	65 MOA	65 MOA			
VHS-4308	4-16x44	SFP	VMR-1 MRAD	No	4.0"	27.4' - 7.4'	CRS <sup>™</sup>	Exposed	30mm	.1 MRAD	5 MRAD	21 MRAD	21 MRAD	50 yds. - ∞	13.3"	20.8 oz.
VHS-4309			VMR-1 MOA							1/4 MOA	12 MOA	75 MOA	75 MOA			
<b>Viper<sup>™</sup> HSLR<sup>™</sup></b>																
VHS-4315-LR	6-24x50	FFP	XLR MOA	No	4.0"	17.8' - 5.1'	CRS <sup>™</sup>	Elevation: Exposed Windage: Capped	30mm	Elevation: 1/2 MOA Windage: 1/4 MOA	Elevation: 24 MOA Windage: 12 MOA	65 MOA	42 MOA	50 yds. - ∞	15.4"	21.8 oz.
VHS-4307-LR	4-16x50	SFP	Dead-Hold <sup>®</sup> BDC MOA	No	4.0"	27.4' - 7.4'	CRS <sup>™</sup>	Capped	30mm	1/4 MOA	12 MOA	75 MOA	50 MOA	50 yds. - ∞	13.6"	21.2 oz.
<b>Viper<sup>™</sup> HS<sup>™</sup></b>																
VHS-4307	4-16x50	SFP	Dead-Hold <sup>®</sup> BDC MOA	No	4.0"	27.4' - 7.4'	N/A	Capped	30mm	1/4 MOA	12 MOA	50 MOA	50 MOA	50 yds. - ∞	13.6"	20.4 oz.
VHS-4305	4-16x44	SFP	Dead-Hold <sup>®</sup> BDC MOA	No	4.0"	27.4' - 7.4'	N/A	Capped	30mm	1/4 MOA	12 MOA	50 MOA	50 MOA	50 yds. - ∞	13.4"	19.2 oz.
VHS-4303	2.5-10x44	SFP	Dead-Hold <sup>®</sup> BDC MOA	No	4.0"	47.0' - 10.9'	N/A	Capped	30mm	1/4 MOA	12 MOA	86 MOA	86 MOA	100 yds.	12.0"	17.3 oz.
<b>Viper<sup>™</sup></b>																
VPR-M-06BDC	6.5-20x50	SFP	Dead-Hold <sup>®</sup> BDC MOA	No	3.1"	17.4' - 6.2'	N/A	Capped	30mm	1/4 MOA	12 MOA	65 MOA	65 MOA	50 yds. - ∞	14.4"	21.6 oz.
VPR-M-06MD			Mil Dot MOA													
<b>Strike Eagle<sup>™</sup></b>																
SE-52504	5-25x56	FFP	EBR-7C MRAD	Yes	3.7"	24.0' - 5.2'	RevStop <sup>®</sup>	Exposed	34mm	.1 MRAD	10 MRAD	31 MRAD*	23 MRAD	15 yds. - ∞	14.6"	30.4 oz.
SE-52503			EBR-7C MOA							1/4 MOA	25 MOA	110 MOA*	78 MOA			
SE-1824-2	1-8x24	SFP	AR-BDC3 MOA	Yes	3.5"	109.0' - 14.4'	N/A	Capped	30mm	1/2 MOA	44 MOA	140 MOA	140 MOA	100 yds.	10.0"	17.4 oz.
SE-1624-2	1-6x24	SFP	AR-BDC3 MOA	Yes	3.5"	116.5' - 19.2'	N/A	Capped	30mm	1/2 MOA	44 MOA	140 MOA	140 MOA	100 yds.	10.5"	18.5 oz.
<b>Venom<sup>™</sup></b>																
VEN-52502	5-25x56	FFP	EBR-7C MRAD	No	3.6"	21.2' - 4.7'	RevStop <sup>®</sup>	Exposed	34mm	.1 MRAD	10 MRAD	25 MRAD	25 MRAD	15 yds. - ∞	15.3"	35.0 oz.
VEN-52501			EBR-7C MOA							1/4 MOA	25 MOA	85 MOA	85 MOA			
<b>Diamondback<sup>™</sup> Tactical</b>																
DBK-10029	6-24x50	FFP	EBR-2C MRAD	No	3.9"	18.0' - 4.5'	N/A	Exposed	30mm	.1 MRAD	6 MRAD	19 MRAD	19 MRAD	10 yds. - ∞	14.3"	24.6 oz.
DBK-10028			EBR-2C MOA							1/4 MOA	15 MOA	65 MOA	65 MOA			
DBK-10027	4-16x44	FFP	EBR-2C MRAD	No	3.8"	26.9' - 6.7'	N/A	Exposed	30mm	.1 MRAD	6 MRAD	25 MRAD	25 MRAD	20 yds. - ∞	14.1"	23.1 oz.
DBK-10026			EBR-2C MOA							1/4 MOA	15 MOA	85 MOA	85 MOA			
DBK-10025	4-12x40	SFP	VMR-1 MOA	No	3.9"	23.6' - 7.9'	N/A	Exposed	1"	1/4 MOA	12 MOA	70 MOA	70 MOA	100 yds.	14.1"	17.5 oz.
<b>Diamondback<sup>™</sup></b>																
DBK-04-BDC	4-12x40	SFP	Dead-Hold <sup>®</sup> BDC MOA	No	3.1"	32.4' - 11.3'	N/A	Capped	1"	1/4 MOA	15 MOA	60 MOA	60 MOA	100 yds.	12.0"	14.2 oz.
DBK-03-BDC	3.5-10x50	SFP	Dead-Hold <sup>®</sup> BDC MOA	No	3.3"	35.8' - 13.5'	N/A	Capped	1"	1/4 MOA	15 MOA	65 MOA	65 MOA	100 yds.	12.5"	15.5 oz.
DBK-01-BDC	3-9x40	SFP	Dead-Hold <sup>®</sup> BDC MOA	No	3.3"	44.6' - 14.8'	N/A	Capped	1"	1/4 MOA	15 MOA	70 MOA	70 MOA	100 yds.	11.6"	14.5 oz.
DBK-M-01P			V-Plex MOA													
DBK-RIM	2-7x35 Rimfire	SFP	V-Plex MOA	No	3.1"	64.3' - 19.3'	N/A	Capped	1"	1/4 MOA	15 MOA	100 MOA	100 MOA	50 yds.	11.6"	13.7 oz.
DBK-08-BDC	1.75-5x32	SFP	Dead-Hold <sup>®</sup> BDC MOA	No	3.5"	68.3' - 23.1'	N/A	Capped	1"	1/4 MOA	15 MOA	125 MOA	125 MOA	100 yds.	10.2"	13.0 oz.

\*Zero stop will limit travel.

# RIFLESCOPE SPECS

SKU	MAGNIFICATION X OBJECTIVE LENS DIAMETER	FOCAL PLANE	RETICLE	ILLUMINATION	EYE RELIEF	LINEAR FIELD OF VIEW (@ 100 YARDS)	ZERO STOP	TURRET STYLE	TUBE SIZE	ADJUSTMENT GRADUATION	TRAVEL PER ROTATION	MAX ELEVATION ADJUSTMENT	MAX WINDAGE ADJUSTMENT	PARALLAX SETTING	LENGTH	WEIGHT
<b>Crossfire® II</b>																
CF2-31045	6-24x50	SFP	Dead-Hold® BDC MOA	No	4.0"	17.3' - 4.4'	N/A	Capped	30mm	1/4 MOA	15 MOA	40 MOA	40 MOA	10 yds. - ∞	14.5"	23.0 oz.
CF2-31029	6-18x44	SFP	V-Brite® MOA	Yes	3.7"	15.2' - 5.2'	N/A	Capped	1"	1/4 MOA	15 MOA	50 MOA	50 MOA	10 yds. - ∞	13.5"	20.8 oz.
CF2-31033			Dead-Hold® BDC MOA	No												19.7 oz.
CF2-31039	4-16x50	SFP	Dead-Hold® BDC MOA	No	3.7"	25.0' - 3.7'	N/A	Capped	30mm	1/4 MOA	15 MOA	50 MOA	50 MOA	25 yds. - ∞	14.4"	23.2 oz.
CF2-31023	4-12x50	SFP	Dead-Hold® BDC MOA	No	3.9"	25.7' - 8.4'	N/A	Capped	1"	1/4 MOA	15 MOA	50 MOA	50 MOA	10 yds. - ∞	14.3"	21.6 oz.
CF2-31015	4-12x44	SFP	Dead-Hold® BDC MOA	No	3.9"	24.7' - 8.4'	N/A	Capped	1"	1/4 MOA	15 MOA	50 MOA	50 MOA	100 yds.	13.4"	15.6 oz.
CF2-31013			V-Plex MOA													15.6 oz.
CF2-31019	4-12x40	SFP	Dead-Hold® BDC MOA	No	3.9"	24.7' - 8.4'	N/A	Capped	1"	1/4 MOA	15 MOA	50 MOA	50 MOA	10 yds. - ∞	13.6"	18.3 oz.
CF2-31049	3-12x56 Hog Hunter	SFP	V-Brite® MOA	Yes	3.5"	36.7' - 9.2'	N/A	Capped	30mm	1/4 MOA	15 MOA	60 MOA	60 MOA	10 yds. - ∞	13.5"	27.9 oz.
CF2-31027			V-Brite® MOA	Yes												18.5 oz.
CF2-31011	3-9x50	SFP	Dead-Hold® BDC MOA	No	3.8"	32.0' - 12.9'	N/A	Capped	1"	1/4 MOA	15 MOA	60 MOA	60 MOA	100 yds.	12.8"	18.0 oz.
CF2-31011SW			Straight-Wall BDC MOA													18.4 oz.
CF2-31025	3-9x40	SFP	V-Brite® MOA	Yes	3.8"	34.1' - 12.6'	N/A	Capped	1"	1/4 MOA	15 MOA	60 MOA	60 MOA	100 yds.	12.2"	16.0 oz.
CF2-31007			Dead-Hold® BDC MOA	No												14.8 oz.
CF2-31005	2-7x32 Crossbow Kit	SFP	V-Plex MOA	No	2.7"	57.5' - 16.4'	N/A	Capped	30mm	1/2 MOA	30 MOA	160 MOA	160 MOA	75 yds.	9.5"	14.0 oz.
CF2-CB1			XBR-2® MOA	Yes												14.0 oz.
CF2-31002	2-7x32 Scout	SFP	V-Plex MOA	No	9.5"	18.3' - 5.2'	N/A	Capped	1"	1/4 MOA	15 MOA	60 MOA	60 MOA	100 yds.	10.7"	12.0 oz.
CF2-31001R	2-7x32 Rimfire	SFP	V-Plex MOA	No	3.9"	42.0' - 12.6'	N/A	Capped	1"	1/4 MOA	15 MOA	60 MOA	60 MOA	50 yds.	11.5"	13.9 oz.
CF2-31003	2-7x32	SFP	Dead-Hold® BDC MOA	No	3.9"	42.0' - 12.6'	N/A	Capped	1"	1/4 MOA	15 MOA	60 MOA	60 MOA	100 yds.	11.5"	14.3 oz.
CF2-31001			V-Plex MOA													14.3 oz.
CF2-31037	1-4x24	SFP	V-Brite® MOA	Yes	4.0"	96.1' - 24.1'	N/A	Capped	30mm	1/2 MOA	30 MOA	100 MOA	100 MOA	100 yds.	9.6"	15.6 oz.

# RED DOT SPECS

SKU	DOT SIZE	DOT COLOR	BATTERY TYPE	BATTERY LIFE	EYE RELIEF	MAGNIFICATION	ADJUSTMENT GRADUATION	TRAVEL PER ROTATION	MAX ELEVATION ADJUSTMENT	MAX WINDAGE ADJUSTMENT	PARALLAX SETTING	LENGTH	WEIGHT (W/BATTERY & HIGHEST MOUNT)
<b>AMG® UH-1™ Gen II</b>													
AMG-HS02	EBR-CQB 1 MOA	Bright Red	CR123A	1,000 hrs.	Unlimited	1x	1/2 MOA	16.5 MOA	100 MOA	100 MOA	Parallax Free	3.9"	11.6 oz.
<b>SPARC® SOLAR</b>													
SPC-404	2 MOA	Bright Red	CR2032	150,000 hrs.	Unlimited	1x	1 MOA	42 MOA	100 MOA	100 MOA	Parallax Free	2.6"	5.9 oz.
<b>SPARC® AR</b>													
SPC-AR2	2 MOA	Bright Red	AAA	50,000 hrs.	Unlimited	1x	1 MOA	40 MOA	90 MOA	90 MOA	Parallax Free	2.9"	8.6 oz.
<b>Strikefire® II</b>													
SF-BR-504	4 MOA	Bright Red	CR2	50,000 hrs.	Unlimited	1x	1/2 MOA	30 MOA	100 MOA	100 MOA	Parallax Free	5.6"	12.8 oz.
SF-RG-501	4 MOA	Red/Green	CR2	360 hrs.	Unlimited	1x	1/2 MOA	30 MOA	100 MOA	100 MOA	Parallax Free	5.6"	12.8 oz.
<b>Crossfire®</b>													
CF-RD2	2 MOA	Bright Red	CR2032	50,000 hrs.	Unlimited	1x	1 MOA	40 MOA	100 MOA	100 MOA	Parallax Free	2.5"	5.3 oz.
<b>Razor®</b>													
RZR-2001	3 MOA	Bright Red	CR2032	282 hrs.	Unlimited	1x	1 MOA	30 MOA	170 MOA	114 MOA	Parallax Free	1.8"	2.3 oz.
RZR-2003	6 MOA	Bright Red	CR2032	282 hrs.	Unlimited	1x	1 MOA	30 MOA	170 MOA	114 MOA	Parallax Free	1.8"	2.3 oz.
<b>Viper®</b>													
VRD-6	6 MOA	Bright Red	CR2032	10,000 hrs.	Unlimited	1x	1 MOA	48 MOA	120 MOA	120 MOA	Parallax Free	1.8"	2.0 oz.
<b>Venom®</b>													
VMD-3103	3 MOA	Bright Red	CR1632	900 hrs.	Unlimited	1x	1 MOA	30 MOA	130 MOA	100 MOA	Parallax Free	1.9"	1.7 oz.
VMD-3106	6 MOA	Bright Red	CR1632	900 hrs.	Unlimited	1x	1 MOA	30 MOA	130 MOA	100 MOA	Parallax Free	1.9"	1.7 oz.

# PRISM SCOPE SPECS

SKU	MAGNIFICATION	OBJECTIVE LENS DIAMETER	RETICLE	RETICLE COLOR	LINEAR FIELD OF VIEW (@ 100 YARDS)	EYE RELIEF	ADJUSTMENT GRADUATION	TRAVEL PER ROTATION	MAX ELEVATION ADJUSTMENT	MAX WINDAGE ADJUSTMENT	PARALLAX SETTING	BATTERY TYPE	LENGTH	WEIGHT (W/BATTERY & HIGHEST MOUNT)
<b>Spitfire® HD Gen II</b>														
SPR-500	5x	25mm	AR-BDC4 MOA	Red	23.3'	2.7"	1 MOA	42 MOA	200 MOA	200 MOA	100 yds.	CR2032	3.6"	10.8 oz.
SPR-300	3x	21mm	AR-BDC4 MOA	Red	37.9'	2.6"	1 MOA	42 MOA	250 MOA	250 MOA	100 yds.	CR2032	3.0"	9.3 oz.
<b>Spitfire® AR</b>														
SPR-200	1x	25mm	DRT MOA	Red/Green	79.0'	3.8"	1/2 MOA	30 MOA	120 MOA	120 MOA	Parallax Free	AAA	4.5"	11.2 oz.



# BINOCULAR SPECS

SKU	MAGNIFICATION X OBJECTIVE LENS DIAMETER	LINEAR FIELD OF VIEW (@ 1000 YARDS)	ANGULAR FIELD OF VIEW	CLOSE FOCUS	EYE RELIEF	INTERPUPILLARY DISTANCE	DIOPTER RANGE	PRISM TYPE	PRISM MATERIAL	HEIGHT	WIDTH	WEIGHT
<b>Razor® UHD</b>												
RZB-3104	18x56	194'	3.7°	10.0'	18.0mm	56mm - 76mm	+/- 2	Roof-Abbe Koenig	BK7	8.4"	6.2"	42.0 oz.
RZB-3103	12x50	288'	5.5°	6.6'	17.0mm	56mm - 76mm	+/- 2	Roof-Abbe Koenig	BK7	7.6"	5.9"	36.5 oz.
RZB-3105	10x50	341'	6.5°	6.6'	18.0mm	56mm - 76mm	+/- 3	Roof-Abbe Koenig	BK7	7.6"	5.9"	36.5 oz.
RZB-3102	10x42	346'	6.6°	4.5'	16.7mm	56mm - 76mm	+/- 2	Roof-Abbe Koenig	BK7	7.0"	5.7"	32.4 oz.
RZB-3101	8x42	420'	8.0°	4.5'	16.7mm	56mm - 76mm	+/- 2	Roof-Abbe Koenig	BK7	7.0"	5.7"	32.4 oz.
<b>Razor® HD</b>												
RZB-2104	12x50	285'	5.4°	10.0'	15.5mm	57mm - 74mm	+/- 3.5	Roof-Schmidt Pechan	BaK4 + BaK7	6.8"	5.1"	28.7 oz.
RZB-2103	10x50	315'	6.0°	10.0'	16.5mm	57mm - 74mm	+/- 3.5	Roof-Schmidt Pechan	BaK4 + BaK7	6.8"	5.1"	28.1 oz.
RZB-2102	10x42	362'	6.9°	6.0'	16.5mm	55mm - 75mm	+/- 3.5	Roof-Schmidt Pechan	BaK4 + BaK7	5.9"	5.1"	24.8 oz.
RZB-2101	8x42	388'	7.4°	6.0'	17.5mm	55mm - 75mm	+/- 3.5	Roof-Schmidt Pechan	BaK4 + BaK7	5.9"	5.1"	24.2 oz.
<b>Kaibab® HD</b>												
KAI-5618	18x56	194'	3.7°	19.8'	16.4mm	60mm - 76mm	+/- 3	Roof-Schmidt Pechan	BaK4 + BaK7	7.7"	5.7"	43.5 oz.
<b>Viper® HD</b>												
V203	12x50	288'	5.5°	8.0'	16.0mm	59mm - 75mm	+/- 4	Roof-Schmidt Pechan	BaK4 + BaK7	6.5"	5.2"	28.8 oz.
V202	10x50	346'	6.6°	8.0'	16.0mm	59mm - 75mm	+/- 2.5	Roof-Schmidt Pechan	BaK4 + BaK7	6.5"	5.2"	28.4 oz.
V201	10x42	341'	6.5°	6.0'	17.0mm	55mm - 74mm	+/- 4	Roof-Schmidt Pechan	BaK4 + BaK7	5.6"	4.9"	24.9 oz.
V200	8x42	409'	7.8°	6.0'	18.0mm	55mm - 74mm	+/- 2.5	Roof-Schmidt Pechan	BaK4 + BaK7	5.6"	4.9"	24.5 oz.
<b>Diamondback® HD</b>												
DB-218	15x56	230'	4.4°	14.0'	15.6mm	59mm - 76mm	+/- 3	Roof-Schmidt Pechan	BaK4	7.1"	5.8"	34.8 oz.
DB-217	12x50	271'	5.2°	6.0'	14.0mm	60mm - 75mm	+/- 5	Roof-Schmidt Pechan	BaK4	6.4"	5.3"	28.9 oz.
DB-216	10x50	315'	6.0°	6.0'	17.0mm	60mm - 75mm	+/- 5	Roof-Schmidt Pechan	BaK4	6.6"	5.3"	30.0 oz.
DB-215	10x42	330'	6.3°	5.0'	15.0mm	55mm - 73mm	+/- 4	Roof-Schmidt Pechan	BaK4	5.7"	5.1"	21.3 oz.
DB-214	8x42	393'	7.5°	5.0'	17.0mm	55mm - 73mm	+/- 4	Roof-Schmidt Pechan	BaK4	5.7"	5.1"	21.8 oz.
DB-213	10x32	340'	6.5°	6.0'	14.0mm	57mm - 73mm	+/- 4	Roof-Schmidt Pechan	BaK4	4.4"	5.0"	16.0 oz.
DB-212	8x32	426'	8.1°	5.0'	16.0mm	57mm - 73mm	+/- 4	Roof-Schmidt Pechan	BaK4	4.4"	5.0"	15.9 oz.
DB-211	10x28	273'	5.1°	6.0'	16.0mm	55mm - 72mm	+/- 3	Roof-Schmidt Pechan	BaK4	4.6"	4.5"	13.3 oz.
DB-210	8x28	332'	6.2°	6.0'	18.0mm	55mm - 72mm	+/- 3	Roof-Schmidt Pechan	BaK4	4.6"	4.5"	13.7 oz.
<b>Crossfire® HD</b>												
CF-4314	12x50	273'	5.2°	6.0'	15.0mm	60mm - 76mm	+/- 3	Roof-Schmidt Pechan	BaK4	6.6"	5.3"	29.5 oz.
CF-4313	10x50	320'	6.1°	6.0'	17.0mm	60mm - 76mm	+/- 3	Roof-Schmidt Pechan	BaK4	6.7"	5.3"	30.4 oz.
CF-4312	10x42	325'	6.2°	6.0'	15.0mm	58mm - 75mm	+/- 3	Roof-Schmidt Pechan	BaK4	6.0"	5.2"	23.0 oz.
CF-4311	8x42	393'	7.5°	6.0'	17.0mm	58mm - 75mm	+/- 3	Roof-Schmidt Pechan	BaK4	6.2"	5.2"	23.8 oz.



# BINOCULAR SPECS

SKU	MAGNIFICATION X OBJECTIVE LENS DIAMETER	LINEAR FIELD OF VIEW (@ 1000 YARDS)	ANGULAR FIELD OF VIEW	CLOSE FOCUS	EYE RELIEF	INTERPUPILLARY DISTANCE	DIOPTER RANGE	PRISM TYPE	PRISM MATERIAL	HEIGHT	WIDTH	WEIGHT
<b>Raptor™</b>												
R310	10x32	339'	6.3°	15.0'	13.0mm	50mm - 70mm	+/- 4	Porro	BaK4	5.1"	6.2"	19.0 oz.
R385	8.5x32	390'	7.4°	15.0'	14.0mm	50mm - 70mm	+/- 4	Porro	BaK4	5.0"	6.2"	18.7 oz.
<b>Vanquish™</b>												
VNQ-1026	10x26	294'	5.6°	7.6'	16.0mm	57mm - 71mm	+/- 2	Reverse Porro	BaK4	4.3"	4.6"	12.7 oz.
VNQ-0826	8x26	352'	6.7°	7.6'	15.0mm	57mm - 71mm	+/- 2	Reverse Porro	BaK4	4.3"	4.6"	12.7 oz.

# LASER RANGEFINDING BINOCULAR SPECS

SKU	MAGNIFICATION X OBJECTIVE LENS DIAMETER	LINEAR FIELD OF VIEW (@ 1000 YARDS)	ANGULAR FIELD OF VIEW	CLOSE FOCUS	EYE RELIEF	INTERPUPILLARY DISTANCE	DIOPTER RANGE	MAX REFLECTIVE RANGE (UP TO)	TREE RANGE (UP TO)	DEER RANGE (UP TO)	MIN RANGE	HEIGHT	WIDTH	WEIGHT
<b>Fury™ HD 5000 AB</b>														
LRF302	10x42	321'	6.1°	18.5'	16.0mm	58mm - 72mm	+/- 3	5000 yds.	2400 yds.	1600 yds.	5 yds.	5.8"	5.0"	32.4 oz.
<b>Fury™ HD 5000</b>														
LRF301	10x42	321'	6.1°	18.5'	16.0mm	58mm - 72mm	+/- 3	5000 yds.	2400 yds.	1600 yds.	5 yds.	5.8"	5.0"	32.3 oz.

# RANGEFINDER SPECS

SKU	MAGNIFICATION	OBJECTIVE LENS DIAMETER	MAX REFLECTIVE RANGE (UP TO)	TREE RANGE (UP TO)	DEER RANGE (UP TO)	MIN RANGE	ACCURACY (@ 100 YARDS)	MAX ANGLE READING	LINEAR FIELD OF VIEW (@ 1000 YARDS)	ANGULAR FIELD OF VIEW	EYE RELIEF	LENGTH	HEIGHT	WIDTH	WEIGHT
<b>Razor™ HD 4000</b>															
LRF-250	7x	25mm	4000 yds.	2500 yds.	2200 yds.	5 yds.	+/- .5 yds.	+/- 70°	341'	6.5°	19mm	4.3"	3.1"	1.7"	9.9 oz.
<b>Ranger™ 1800</b>															
RRF-181	6x	22mm	1800 yds.	1000 yds.	900 yds.	10 yds.	+/- 1 yd.	+/- 60°	315'	6.0°	17mm	3.9"	3.0"	1.6"	7.7 oz.
<b>Impact™ 1000</b>															
LRF101	6x	20mm	1000 yds.	800 yds.	500 yds.	5 yds.	+/- 1 yd.	+/- 60°	341'	6.5°	15mm	3.8"	3.0"	1.4"	5.5 oz.



# MONOCULAR SPECS

SKU	MAGNIFICATION X OBJECTIVE LENS DIAMETER	LINEAR FIELD OF VIEW (@ 1000 YARDS)	ANGULAR FIELD OF VIEW	CLOSE FOCUS	EYE RELIEF	DIOPTER RANGE	EYECUP STYLE	LENGTH	WEIGHT
<b>Recon® R/T</b>									
RT155	15x50	215'	4.1°	12.0'	16.0mm	+/- 3	Winged	8.0"	15.2 oz.
<b>RECCE Pro® HD</b>									
RP-100	8x32	400'	7.6°	5.0'	14.5mm	+/- 3	Winged	6.0"	10.5 oz.
<b>Solo® R/T</b>									
SOL-3608-RT	8x36	393'	7.5°	16.4'	18.0mm	+/- 4	Winged	5.4"	10.7 oz.
<b>Solo®</b>									
S136	10x36	325'	6.2°	16.4'	15.0mm	N/A	Adjustable	4.9"	9.3 oz.
S836	8x36	393'	7.5°	16.4'	18.0mm	N/A	Adjustable	4.9"	9.7 oz.
S105	10x25	315'	6.0°	16.4'	14.5mm	N/A	Adjustable	4.4"	5.6 oz.
S825	8x25	378'	7.2°	16.4'	15.0mm	N/A	Adjustable	4.4"	5.6 oz.

# SPOTTING SCOPE SPECS

SKU	MAGNIFICATION X OBJECTIVE LENS DIAMETER	EYEPiece POSITION	LINEAR FIELD OF VIEW (@ 1000 YARDS)	ANGULAR FIELD OF VIEW	CLOSE FOCUS	EYE RELIEF	LENGTH	WEIGHT
<b>Razor® HD</b>								
RS-85A	27-60x85	Angled	117' - 68'	2.2° - 1.3°	16.4'	16.7mm - 17.0mm	15.5"	65.6 oz.
RS-85S		Straight					16.2"	
RS-65A	22-48x65	Angled	138' - 84'	2.7° - 1.6°	26.2'	16.7mm - 17.0mm	14.8"	56.8 oz.
RS-65S		Straight					15.6"	
RZR-50A1	11-33x50	Angled	191' - 96'	3.6° - 1.8°	6.6'	16.0mm - 19.0mm	10.3"	25.0 oz.
RZR-50S1		Straight					11.0"	
<b>Viper® HD</b>								
V502	20-60x85	Angled	101' - 50'	1.9° - 1.0°	36.0'	17.8mm - 19.6mm	17.5"	76.6 oz.
V503		Straight					18.0"	76.4 oz.
V500	15-45x65	Angled	137' - 68'	2.6° - 1.3°	23.0'	17.8mm - 19.6mm	14.0"	59.0 oz.
V501		Straight					14.6"	58.8 oz.
<b>Diamondback® HD</b>								
DS-85A	20-60x85	Angled	108' - 60'	2.1° - 1.1°	24.6'	18.3mm - 20.3mm	16.0"	60.9 oz.
DS-85S		Straight					15.8"	61.3 oz.
DS-65A	16-48x65	Angled	138' - 72'	2.6° - 1.4°	16.4'	18.3mm - 20.3mm	14.3"	49.8 oz.
DS-65S		Straight					13.7"	50.4 oz.

# TRIPOD SPECS

SKU	HEAD STYLE	WEIGHT	MAX LOAD	HEIGHT (MIN-MAX)	FOLDED DIMENSIONS (HEIGHT X WIDTH)	LEG MATERIAL	LEG SECTIONS	LEG ANGLES	LEG LOCKS	HEAD MOUNT
<b>Radian™ Carbon</b>										
TR-RADB	Ball	7.3 lbs.	55 lbs.	8.3" - 67.3"	28.0" x 6.0"	Carbon Fiber	4	3	Twist	Arca-Swiss
TR-RADL	Leveling	6.1 lbs.	44 lbs.	7.8" - 64.3"	25.5" x 6.0"	Carbon Fiber	4	3	Twist	Arca-Swiss
<b>Ridgeview™ Carbon</b>										
TR-RVC	2-Way Pan	3.2 lbs.	22 lbs.	8.3" - 73.8"	29.0" x 3.2"	Carbon Fiber	3	3	1/4 Turn	Arca-Swiss
<b>Summit™ Carbon II</b>										
TR-SMC	2-Way Pan	2.5 lbs.	22 lbs.	6.3" - 53.3"	18.1" x 3.0"	Carbon Fiber	4	3	1/4 Turn	Arca-Swiss
<b>High Country™ II</b>										
TR-HCY	2-Way Pan	4.0 lbs.	22 lbs.	11.3" - 62.5"	24.3" x 4.0"	Aluminum	3	3	Flip Lever	Arca-Swiss





# CHEERS

— *TO YOU* —

# VORTEX NATION™



CHEERS TO YOU VORTEX NATION™

VORTEXOPTICS.COM



HOW TO MAKE A

## WISCONSIN BRANDY OLD FASHIONED “SWEET”

If we can't sit down and have a drink with you in person, the least we can do is help you make one. The Brandy Old Fashioned "Sweet" is a Wisconsin tradition that runs as deep as our love for you. This one's on us. Cheers, Vortex Nation™.

### INGREDIENTS:

Orange, sliced  
Maraschino Cherries  
Sugar Cubes  
Aromatic Bitters  
Korbel Brandy®  
Lemon-Lime Soda

### INSTRUCTIONS:

In a rocks glass, muddle 1 orange slice, 2 maraschino cherries, 1 sugar cube (1 tsp.), and 3–4 dashes of bitters  
Add 2 oz. brandy and fill with ice  
Top with lemon-lime soda (7UP®, Sprite®, etc.)  
Garnish with a skewered cherry and orange slice





VORTEX®

2022 CATALOG